



THE
LANGDON
GROUP



GATEWAY
MAPPING
INC.

J-U-B ENGINEERS, INC.



CITY OF UMATILLA Transportation Master Plan

MAY 2023

Executive Summary

The Umatilla Transportation System Plan (TSP) was first adopted in 1999. Since then, various other planning studies have been performed to assist the City in developing the transportation system to serve the community. All modes are addressed, however the focus is on the roadway element. This Transportation Plan has been prepared to forecast growth in population, employment and traffic in the next 20 years and identify improvements to meet the forecast growth.

The Introduction section discusses goals and policies to help guide staff and elected officials in their stewardship with the transportation system. It also provides documentation of accomplishments with respect to past physical improvements as well as studies that have been completed since the original TSP was prepared.

Chapter 2 presents existing conditions for land use, population, the roadway network, pavement condition traffic operations and collision history. The population in 2020 was 7,363, up from just under 5,000 since year 2000. Nearly 35% of city streets have good or very good pavement condition, with approximately 40% being poor or very poor and 25% having fair pavement condition. There are currently two intersections (I-82 northbound ramps/US 730 and US 730/River Road that function with poor level of service. Two other intersections are also nearing unacceptable delay at US 730/US 395 and US 730/Willamette Street. In the last five years there have been 214 automobile collisions in the City of Umatilla. No fatalities have occurred, with five collisions resulting in serious injuries. Suspected minor injuries came from 11% of the collisions with the remaining 87% having possible injuries or no apparent injury.

Other modes of transportation are discussed in Chapter 3, including bicycle and pedestrian travel with a summary of the 2020 Trails Master Plan and its' 11 recommended projects. Transit, rail, air, water and pipeline transport are also discussed.

Chapter 4 discusses anticipated future population and development. Significant development is anticipated both residential and industrial in the South Hill area, for which the Urban Growth Area was expanded to serve industrial growth. Additional industrial growth is also anticipated at the east end of the city. Traffic volumes were projected for year 2043 and traffic operations analysis was performed for those volumes to determine where capacity issues would result. Several intersections (7 of the 13 studied) are expected to need additional lanes or improved traffic control in order to serve the forecast traffic volumes. The future roadway network needed to serve the anticipated growth is also discussed, including new connections, potential detour routes for downtown, roadway standards to better serve all modes, access management standards to preserve investments in infrastructure and traffic impact analysis guidelines to ensure that proposed developments contribute to impacts caused by those developments.

Chapter 5 discusses the public involvement components of the preparation of this TSP: Stakeholder interviews were conducted, a Technical Advisory Committee provided input and guidance, and two public open houses were held.

Alternatives Analysis for the seven intersections that are forecast to have unacceptable Levels of Service are discussed in Chapter 6. The alternatives consider geometric changes such as new lanes, traffic control upgrades, potential phasing, physical impediments, queueing and the year improvements will likely be needed.

Chapter 7 discusses the principles of Pavement Management and the importance of maintenance of roadway surfaces in order to preserve the investment in roadway infrastructure.

Chapter 8 presents the transportation projects included in the Capital Improvement Plan that are shown in the table below and graphically in the following figure. Other projects included in the Trails Master Plan and the Bicycle and Pedestrian Plan are included by reference. Chapter 9 presents strategies for implementation of these improvements.



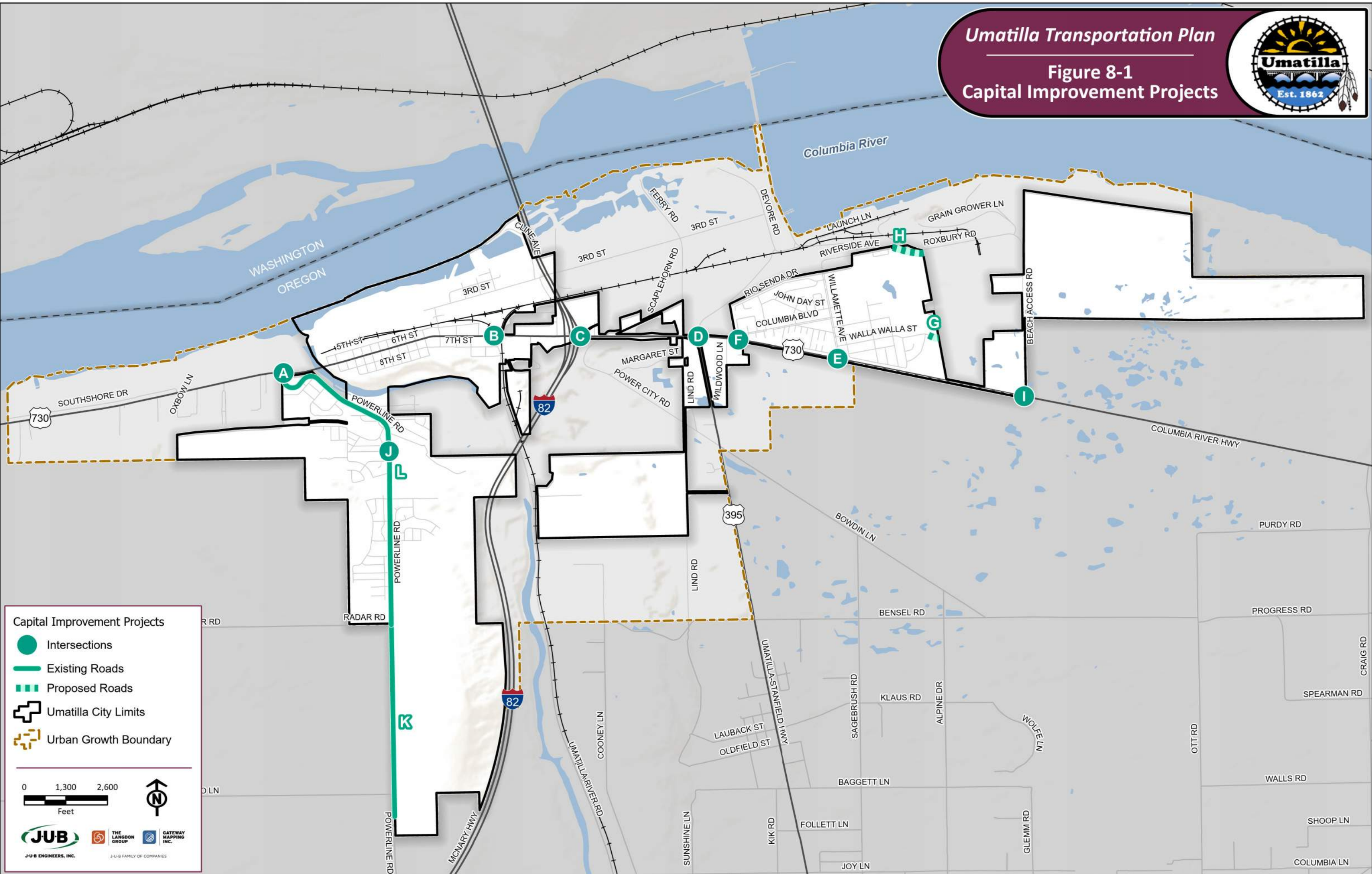

Summary of Capital Improvement Projects

Project Location	Map Location	Description	Timeframe	Cost (\$ Millions)
Powerline/US 730	A	1. Use striping to create additional westbound departure lane	2023	*
		2. Install single lane roundabout	2028	\$1.403
River Road/US 730	B	1. Use striping to create additional westbound departure lane	2023	*
		2. Install traffic signal	2028- 2033	\$0.870
I-82 Northbound ramps/US 730	C	Install traffic signal, with exclusive westbound right turn lane	2023-2028	\$1.433
US 395/US 730	D	Add 2nd northbound left turn lane and 2nd westbound left turn lane with southbound receiving lane	2028-2033	\$4.007
Willamette/US 730	E	Add southbound left turn lane	2028-2033	\$0.107
Columbia/US 730	F	Add eastbound left turn lane and widen north leg to allow one inbound lane and a southbound right turn lane and left turn lane (make full access)	2028-2033	\$0.648
Walla Walla Road Extension	G	Construct Walla Walla Road eastward to connect to Bud Draper Road	2028-2033	\$0.407
Riverside Avenue Extension	H	Construct Riverside Avenue Extension eastward to connect to Roxbury Drive or Bud Draper Road	2028-2033	\$0.964
Beach Access/US 730	I	Extend Storage for southbound right turn lane.	2038-2043	\$0.163
Powerline/Madison	J	Add eastbound left turn lane and southbound right turn lane.	2038-2043	\$0.128
Powerline Widening - Phase 1	K	Widen Powerline Road south of Radar Road 1.07 miles to include two-way left-turn lane and 10' bike path	2023 - 2028	\$4.685
Powerline Widening - Phase 2	L	Widen Powerline Road south US 730 to include two-way left-turn lane and sidewalks on both sides	2023 - 2028	\$8.626

* These short term projects are minimal in cost and could be incorporated with ODOT or City maintenance efforts (with ODOT approval).



Capital Improvement Projects

-  Intersections
-  Existing Roads
-  Proposed Roads
-  Umatilla City Limits
-  Urban Growth Boundary

0 1,300 2,600
 Feet



JUB THE LANGDON GROUP GATEWAY MAPPING INC.
 J-U-B ENGINEERS, INC. J-U-B FAMILY OF COMPANIES

TABLE OF CONTENTS

Chapter 1 - Introduction..... 1-1

 1.1 Background..... 1-1

 1.2 Purpose of the Plan 1-1

 1.3 Goals 1-1

 1.4 Policies 1-3

 1.5 Accomplishments 1-4

 Roadway Improvements..... 1-4

 Planning Studies..... 1-4

Chapter 2 - Existing Conditions 2-1

 2.1 Land Use 2-1

 2.2 Current and Historical Population 2-1

 2.3 Roadway Network 2-3

 2.4 Pavement Condition 2-7

 2.5 Traffic Volumes and Level of Service 2-10

 Seasonal Adjustment Factors..... 2-10

 Traffic Operations Standards..... 2-10

 Port of Entry..... 2-12

 Traffic Operations Analysis..... 2-13

 2.6 Crash History..... 2-14

Chapter 3 - Other Modes of Transportation 3-1

 3.1 Bicycle and Pedestrian Facilities 3-1

 Umatilla Trails Master Plan..... 3-1

 Pedestrian & Bicycle Master Plan..... 3-2

 Other Efforts..... 3-2

 3.2 Transit 3-4

 3.3 Rail 3-6

 3.4 Air..... 3-6

 3.5 Water 3-6

 3.6 Pipelines..... 3-7

Chapter 4 - Future Conditions 4-1

 4.1 Future Population 4-1

 4.2 Anticipated Development..... 4-1

 4.3 Design Standards 4-1

 Roadway Design Standards..... 4-1

 Access Management..... 4-1

 Traffic Impact Analysis..... 4-3

 4.4 Traffic Volume Forecasts 4-3

 4.5 Traffic Operations Analysis 4-4

 4.6 Future Roadway Network..... 4-6

- Chapter 5 - Public Involvement5-1
- Chapter 6 - Alternatives Analysis6-1
- Chapter 7 - Pavement Management..... 7-1
 - 7.1 Current Pavement Management Practice..... 7-1
 - 7.2 Pavement Management Principles..... 7-1
- Chapter 8 - Capital Improvement Plan.....8-1
- Chapter 9 - Implementation Plan.....9-1
 - 9.1 Implementation Overview.....9-1
 - 9.2 Grants and Funding9-1
 - 9.3 Implementation Strategies9-2

LIST OF APPENDICES

Appendix A -- Summary of Related Plans

Appendix B -- Pavement Data

Appendix C -- Traffic Count Information

Appendix D -- Existing Conditions Capacity Analysis Worksheets

Appendix E -- Crash History

Appendix F -- Traffic Forecast Details

Appendix G -- Traffic Impact Analysis Guidelines

Appendix H -- 2043 No-Build Capacity Analysis Worksheets

Appendix I -- Public Involvement Information

Appendix J - 2043 Build Mitigation Scenario Capacity Analysis Worksheets

Appendix K -- Interim Year Forecast Details and Capacity Analysis Worksheets

Appendix L -- Planning Level Cost Estimates

LIST OF FIGURES

Figure 1-1 Planning Area.....	1-2
Figure 2-1 Land Use Map	2-2
Figure 2-2 Functional Classifications	2-4
Figure 2-3 Truck Routes	2-5
Figure 2-4 Existing Intersection Geometry Traffic Control and Traffic Volumes.....	2-6
Figure 2-5 Existing Pavement Conditions.....	2-9
Figure 2-6 Crash Frequency.....	2-16
Figure 2-7 Crash Severity	2-17
Figure 3-1 Trails Plan	3-3
Figure 3-2 Other Modes.....	3-5
Figure 4-1 Anticipated Development within City of Umatilla.....	4-2
Figure 4-2 2043 Traffic Forecasts.....	4-5
Figure 4-3 Future Road Network.....	4-8
Figure 7-1 Typical Pavement Deterioration Curve.....	7-3
Figure 8-1 Capital Improvement Projects	8-3

LIST OF TABLES

Table 2-1 Zoning Designations	2-1
Table 2-2 Historical Population	2-1
Table 2-3 Pavement Condition Miles	2-7
Table 2-4 Good Fair Poor Pavement Rating Sheet.....	2-8
Table 2-5 Seasonal Adjustment Factors.....	2-10
Table 2-6 Level of Service Criteria for Intersections	2-11
Table 2-7 Summary of Existing (2022) PM Peak Hour Delay and Level of Service	2-13
Table 2-8 Injury Type.....	2-14
Table 2-9 Incident Type	2-14
Table 2-10 Collision Type by Intersection	2-15
Table 3-1 Kayak Umatilla Service	3-4
Table 4-1 Recommended Access Management Standards	4-3
Table 4-2 Summary of 2043 PM Peak Hour Delay and Level of Service	4-6
Table 7-1 Typical Pavement Treatment Costs and Increased Remaining Service Life.....	7-4
Table 8-1 Summary of Capital Improvement Projects	8-2

Chapter 1 - Introduction

1.1 Background

The City of Umatilla, in conjunction with the Oregon Department of Transportation (ODOT), developed and adopted their first Transportation System Plan (TSP) in 1999 to guide the management of existing transportation facilities as well as the development of future facilities. The Plan was prepared in compliance with the State of Oregon Revised Statute (ORS) 197.712 and the Transportation Planning Rule (TPR), consistent with the overall City Comprehensive Plan. Since the completion of the 1999 TSP, various other planning studies have been developed and are discussed below. The Urban Growth Boundary was recently expanded to the south. The current city limits and UGB are shown in Figure 1-1.

1.2 Purpose of the Plan

The City of Umatilla allocated funding to prepare a new Transportation System Plan to address anticipated growth the next 20 years. This TSP update reviews existing conditions and anticipated future growth impacts with new 20-year traffic forecasts and identify improvements needed to serve anticipated growth. The TSP is incorporated by reference in the City's Comprehensive Plan, acts as part of the City's development standards and guides its Capital Improvement Program. The TSP is intended to meet the Transportation planning requirements of OAR 660-012-0000.

This TSP focuses on the update of the Road Plan Element. In particular, the functional classification of the road network (existing and proposed) will be reviewed, and areas of future growth will be identified. A roadway inventory and capacity needs assessment was performed and other TSP elements such as trails, rail and transit were addressed consistent with OAR 660-012-0020.

1.3 Goals

Goals were adopted with the original TSP to provide guidance to staff and elected officials in their stewardship of the transportation system. They have been updated through this TSP process.

TSP Goal 1 – Promote a balanced, safe, and efficient transportation system.

Objectives





1. Develop a multi-modal transportation system that avoids reliance upon one form of transportation as well as minimizes energy consumption and air quality impacts.
2. Protect the qualities of neighborhoods and the community.
3. Provide for adequate street capacity and optimum efficiency.
4. Promote adequate transportation linkages between residential, commercial, public, and industrial land uses.

TSP Goal 2 – Ensure the adequacy of the roadway network in terms of function, capacity, level of service, and safety.

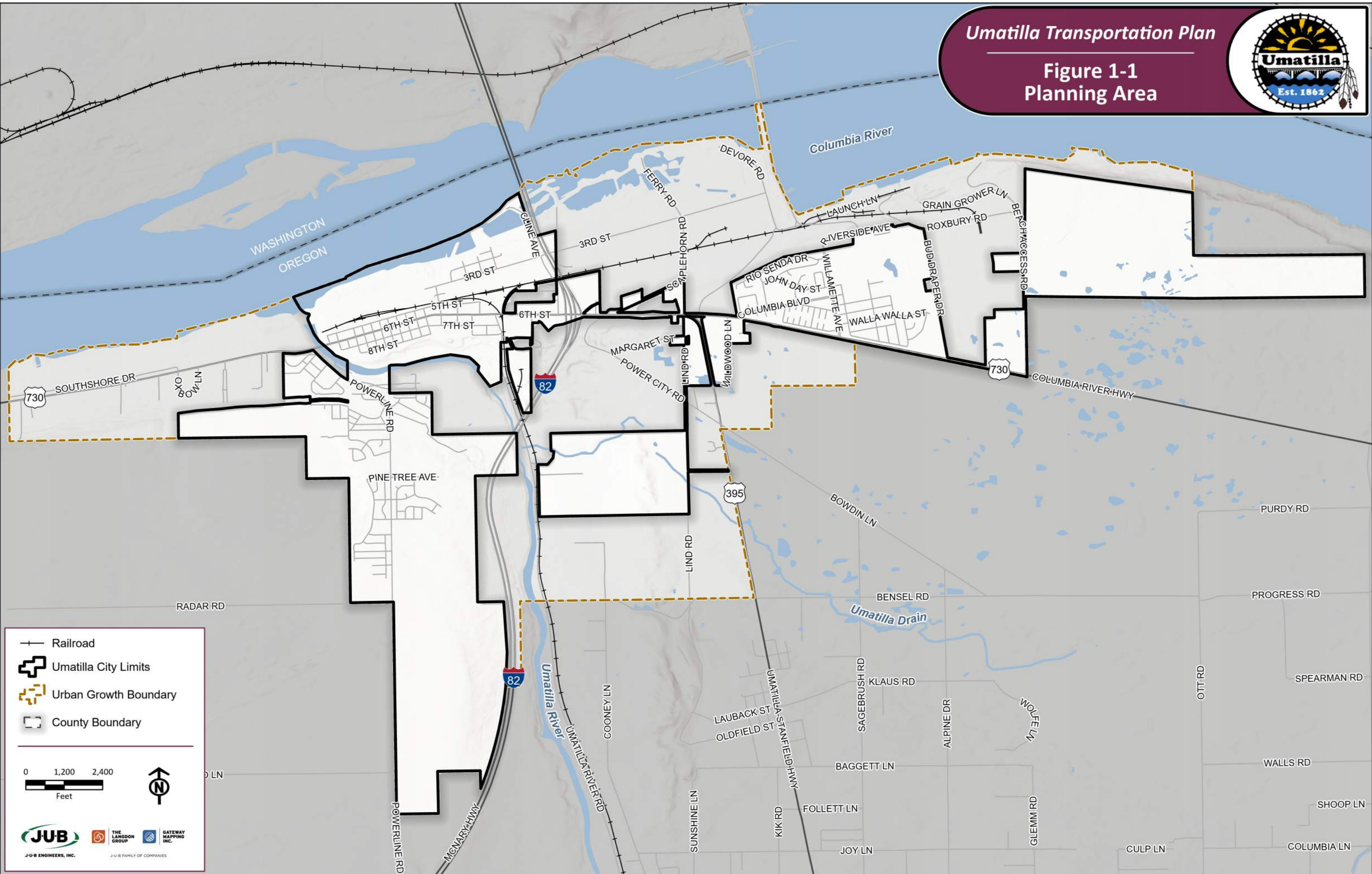
Objectives

1. Develop a functional classification system that addresses all roadways within the study area.
2. In conjunction with the functional classification system, identify corresponding street standards that recognize the unique attributes of the local area.



-  Railroad
-  Umatilla City Limits
-  Urban Growth Boundary
-  County Boundary

0 1,200 2,400
 Feet



JUB THE LANGDON GROUP GATEWAY MAPPING INC.
 J-U-B ENGINEERS, INC. J-U-B FAMILY OF COMPANIES

3. Identify existing and potential future capacity constraints and develop strategies to address those constraints, including potential intersection improvements, future roadway needs, and future street connections.
4. Evaluate the need for modifications to and/or the addition of traffic control devices, including evaluation of traffic signal warrants as appropriate.
5. Identify access spacing standards.
6. Provide an acceptable level of service at all intersections in the City, recognizing the rural character of the area.
7. Identify existing and potential future safety concerns as well as strategies to address those concerns.
8. Provide enhanced access to Highway 730 for the Umatilla Rural Fire District Station 1.

TSP Goal 3 – Promote alternative modes of transportation.

Objectives

1. Develop trail connections identified in the Master Trails Plan and other multi-modal improvement plans that link major activity centers.
2. Encourage the continued use of the Columbia River as a means of transportation.
3. Encourage the continued use of local freight rail service provided by Union Pacific Railroad.
4. Develop a public transit plan that provides local service and connections to regional public transportation services.

TSP Goal 4 – Identify and prioritize transportation improvement needs in the City of Umatilla and identify a set of reliable funding sources that can be applied to these improvements.

Objectives

1. Develop a prioritized list of transportation improvement needs in the study area.
2. Develop construction cost estimates for the identified projects.
3. Evaluate the adequacy of existing funding sources to serve projected improvement needs.
4. Evaluate new innovative funding sources for transportation improvements.

1.4 Policies

The following system-wide Policies were adopted with the original TSP:

1. The City shall promote a balanced, safe and efficient transportation system. In evaluating parts of the system, the City will support proposals that:
 - Protect the qualities of neighborhoods and the community.
 - Provide for adequate street capacity, optimum efficiency and effectiveness.
2. The City will coordinate with ODOT in implementing its improvement program (Ord 544).
3. Development proposals, plan amendments, or zone changes shall conform to the adopted Transportation System Plan.
4. Amendments to the Comprehensive Plan, zoning map, and land use regulations that significantly affect a transportation facility shall assure that allowed uses are consistent with the function, capacity, and Level of Service of the facility identified in the Transportation System Plan. This shall be accomplished by one of the following:
 - Limiting allowed land uses to be consistent with the planned function of the transportation facility;

- Amending the Transportation System Plan to ensure that existing, improved, or new transportation facilities are adequate to support the proposed land uses consistent with the requirement of the Transportation Planning Rule; or,
 - Altering land use designations, densities, or design requirements to reduce demand for automobile travel and meet travel needs through other modes.
5. A proposed Comprehensive Plan amendment or zoning change significantly affects a transportation facility if:
- It changes the functional classification of an existing or planned transportation facility;
 - Changes the standards implementing a functional classification system;
 - Allows types or levels of land use that would result in levels of travel or access that are inconsistent with the functional classification of a transportation facility; or,
 - Would reduce the level of service of the facility below the minimum acceptable level identified in the Transportation System Plan.

1.5 Accomplishments

The City of Umatilla and the ODOT have both completed efforts to improve transportation facilities that serve City residents and visitors. Physical improvements as well as planning studies are briefly discussed below that have been completed since the adoption of the TSP in 1999.

Roadway Improvements

Since the original Transportation System Plan was prepared in 1999, the following major improvements have been completed:

- Powerline Road was realigned to intersect with US 730 further west of the Umatilla River in order to be able to add capacity and safety improvements. Sight distance was improved as well as incorporating a westbound left turn lane to reduced vehicle conflicts.
- Intersection improvements at Eisele Drive/US 730 were also constructed.
- Widening of US 730 to add a center turn lane from west of Bud Draper Road to east of Beach Access Road as well as westbound right turn lanes at both Beach Access Road and Bud Draper Road.
- Improvements to US 730 from I-82 west to the Umatilla River that implement a portion of the Downtown Revitalization Plan including filling in missing sidewalks, adding curb ramps for wheelchairs meeting ADA standards, adding pedestrian crossings, installing medians and consolidating access points as well as street trees and other downtown amenities.

Planning Studies

Several plans that are companion studies to this Transportation System Plan have also been completed and are listed below. These Plans are adopted as part of this TSP and included by reference. Excerpts from these documents are provided in Appendix A.

- 2000 – US 395 North Corridor Plan
- 2002 -- Downtown Revitalization and Circulation Plan
- 2003 – City of Umatilla Pedestrian and Bicycle Master Plan
- 2007 -- US 730 Corridor Refinement Plan
- 2011 – I-82/US 730 Interchange Area Management Plan
- 2020 -- Master Trails Plan
- 2021 – Umatilla River Trail Concept Plan
- 2022 – Umatilla River Bridge Preliminary Engineering Report

Chapter 2 - Existing Conditions

2.1 Land Use

The City of Umatilla is a relatively small community located along the Columbia River in northeast Oregon. There is a mix of residential, commercial, and industrial land uses. The zoning that corresponds to each of these designations is shown in Table 2-1. Figure 2-1 depicts the current land use designations.

The City's Comprehensive Plan is the City's guide for future growth. The City's Comprehensive "Plan Map" designates current zoning and provides a framework for growth opportunities outside the City limits.

Table 2-1 Zoning Designations

Comprehensive Plan Map Designations	Zoning
Residential	Single-Family Residential (R-1), Medium Density Residential (R-2), Multi-Family Residential (R-3), Downtown Residential (DR)
Commercial	Neighborhood Commercial (NC), Downtown Commercial (DC), General Commercial (GC), Downtown Transitional (DT), McNary Center Mixed Use Commercial (MC)
Industrial	Light Industrial (M-1), Heavy Industrial (M-2)

From Table 10-2-1 of City of Umatilla's Zoning Ordinance

2.2 Current and Historical Population

The historical population of the City of Umatilla is presented in Table 2-2. Population increased rapidly from 1970 to 1980. Since the 1990's, the City has been experiencing positive growth.

Table 2-2 Historical Population

Year	Population	Percent Increase
1920	390	97.0%
1930	345	-11.5%
1940	370	7.2%
1950	883	138.6%
1960	617	-30.1%
1970	679	10.0%
1980	3,199	371.1%
1990	3,046	-4.8%
2000*	4,978	63.4%
2010*	6,906	38.7%
2020†	7,363	6.6%

Source: U.S. Census Bureau

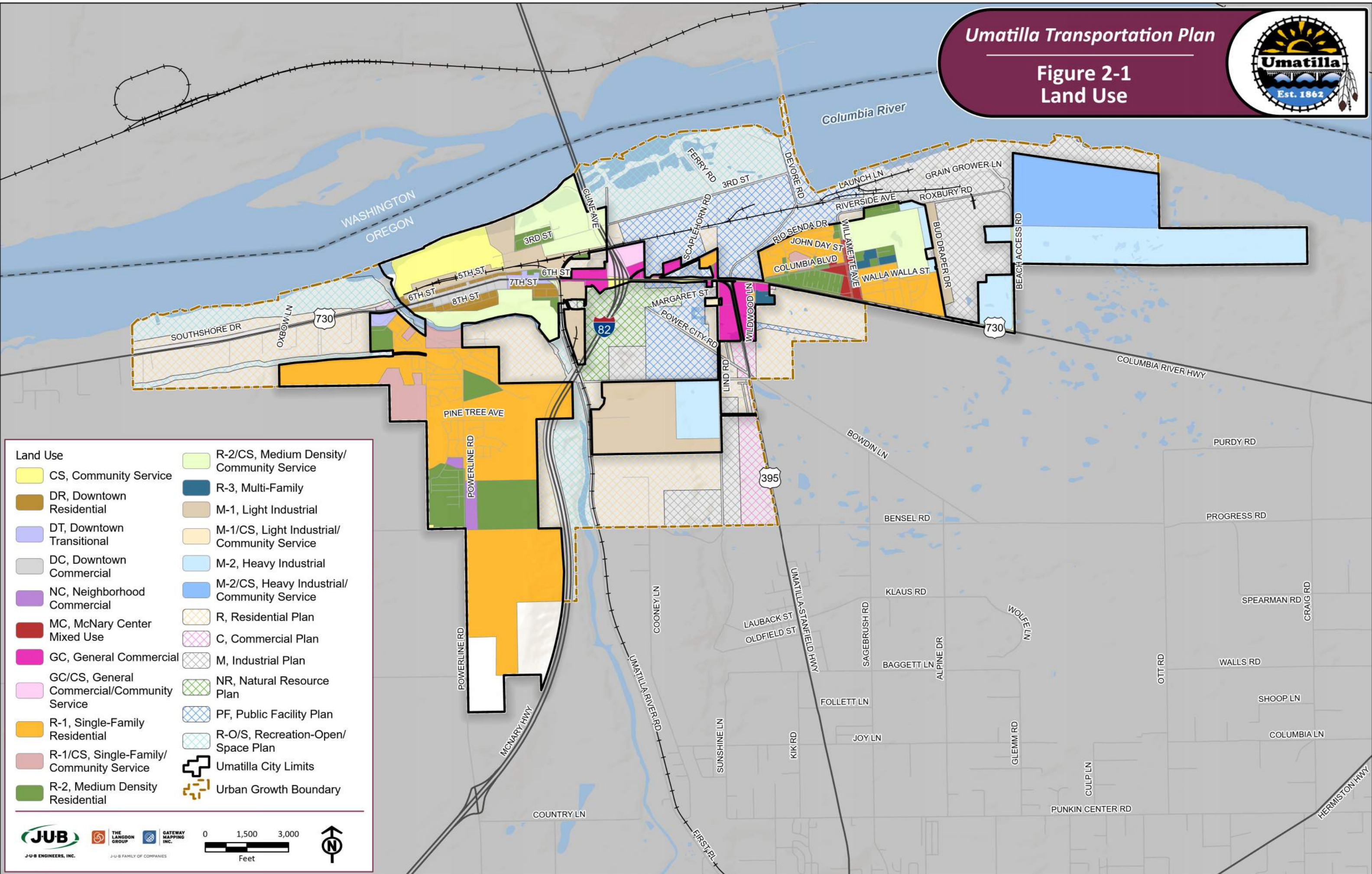

Land Use	
CS, Community Service	R-2/CS, Medium Density/Community Service
DR, Downtown Residential	R-3, Multi-Family
DT, Downtown Transitional	M-1, Light Industrial
DC, Downtown Commercial	M-1/CS, Light Industrial/Community Service
NC, Neighborhood Commercial	M-2, Heavy Industrial
MC, McNary Center Mixed Use	M-2/CS, Heavy Industrial/Community Service
GC, General Commercial	R, Residential Plan
GC/CS, General Commercial/Community Service	C, Commercial Plan
R-1, Single-Family Residential	M, Industrial Plan
R-1/CS, Single-Family/Community Service	NR, Natural Resource Plan
R-2, Medium Density Residential	PF, Public Facility Plan
Umatilla City Limits	R-O/S, Recreation-Open/Space Plan
Urban Growth Boundary	

2.3 Roadway Network

A roadway network is comprised of a hierarchy of roadways that are defined by their function. Generally, roadways serve two primary purposes: access and mobility. It is the degree to which the roadway serves these two functions that defines its functional classification. The functional classification system categorizes a roadway as an arterial, collector, or local road depending on the roadway's primary function.

Figure 2-2 shows the existing functional classification system for the City of Umatilla. There are three primary roadway facilities within the study area: Interstate 82 (I-82), U.S. Highway 730 (US 730), and U.S. Highway 395 (US 395).

Interstate 82 is an east-west divided Interstate Highway which connects I-90 at Ellensburg, WA to I-84 approximately 10.5 miles south of the Oregon-Washington border and serves the Tri-Cities approximately 20 miles to the north of Umatilla. There are two lanes in each direction separated by a center median. It has a posted speed limit of 70 MPH (65 MPH Trucks). In the study area I-82 is oriented in a north-south direction, thus for clarity and for the purposes of this TSP I-82 westbound will be referred to as northbound and I-82 eastbound.

US 730 serves as the primary east-west corridor through town. It connects to I-84 approximately 15 miles to the west and US 12 approximately 23 miles to the east. Entering the City from the west, US 730 has two lanes and adds a center two-way left turn lane as well as sidewalks from east of the Umatilla River to just west of I-82 where it adds one lane in each direction from there to east of US 395. East of US 395 it narrows to four lanes to west of Willamette Street where it briefly narrows to two lanes then adds a center two-way left-turn lane from there to east of Beach Access Road. Posted speed along US 730 ranges from 25 mph (near Umatilla Bridge Road and Jane Avenue) to 55 mph (near the east edge of the city limits).

US 395 is a north-south major route connecting to California and north to Canada. It connects Umatilla with the cities of Hermiston and Stanfield to the south. It has four lanes south of US 730 but adds a center two-way left-turn lane approximately one-half mile south of US 730. It has a posted speed limit of 55 mph between Umatilla and Hermiston.

Existing truck routes are identified in Figure 2-3 below. The major truck routes follow the three primary roadways: Highway 730, Interstate 82, and U.S. 385.

The remaining roads within the City Limits are predominately two-lane roadways. City of Umatilla has some significant barriers for travel, namely the Umatilla River that has a single crossing, I-82 which has only two interchanges for the City, and the railroad that runs east-west north of US 730 which has two crossings west of I-82 and three to the east. Several intersections were selected for evaluation of traffic operations. Their lane configurations and traffic control are shown in Figure 2-4.

Port of Entry – The Port of Entry and weigh station is located on the northwest corner of Brownell Boulevard/US 730 intersection which coincides with the northwest quadrant of the I-82/US 730 interchange. This is a dominant feature in the city of Umatilla that has a significant affect on travel in the vicinity of the interchange and is the primary reason that the Interchange Area Management Plan was developed in 2011. More discussion of the POE is presented later in the Traffic Operations section (2.5.3).

It is important to note that the City of Umatilla and ODOT have established a partnership through the preparation of the Interchange Area Management Plan (IAMP), including Interlocal Government Agreements, which state in part, the following policy statement: "The primary transportation function of the I-82/US 730 interchange is to facilitate statewide, inter-urban, and inter-regional travel between I-82, US 730, and US 395. In addition to this primary function, the I-82/US 730 interchange provides east-west

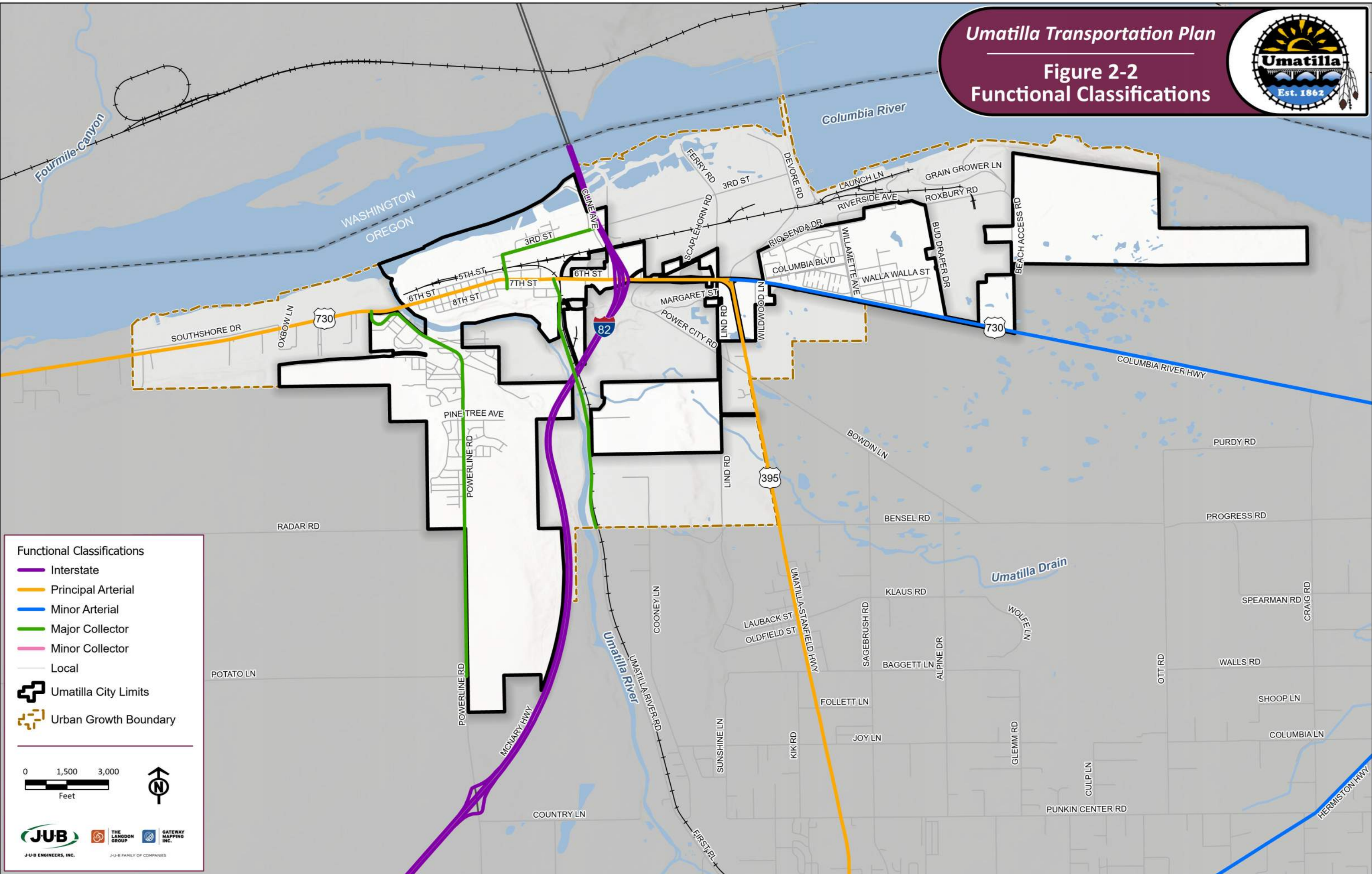

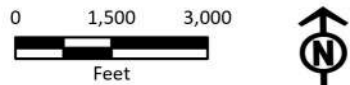

Functional Classifications

- Interstate
- Principal Arterial
- Minor Arterial
- Major Collector
- Minor Collector
- Local
-  Umatilla City Limits
-  Urban Growth Boundary

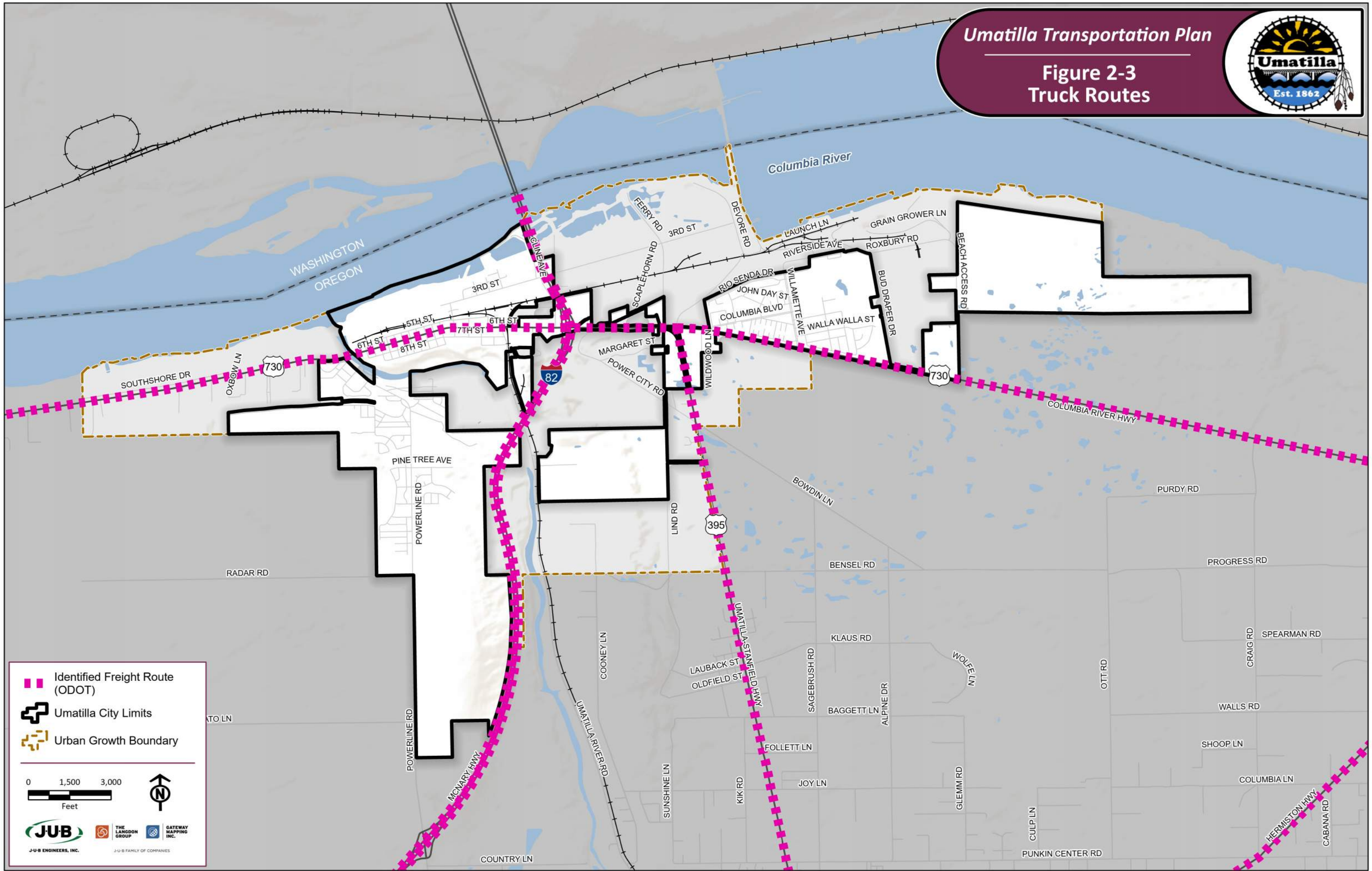



 Identified Freight Route (ODOT)
 Umatilla City Limits
 Urban Growth Boundary

0 1,500 3,000
 Feet



 THE LANGDON GROUP GATEWAY MAPPING INC.
 J-U-B ENGINEERS, INC. J-U-B FAMILY OF COMPANIES

Umatilla Transportation Plan

Figure 2-4
Existing Intersection Geometry, Traffic Control, & Traffic Volumes

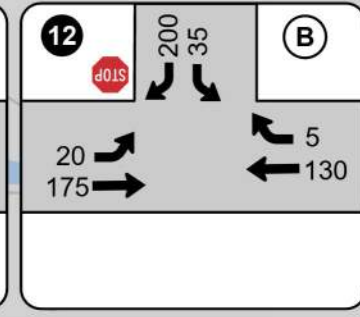
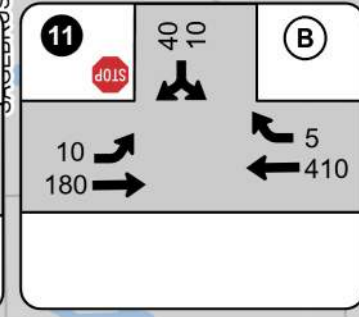
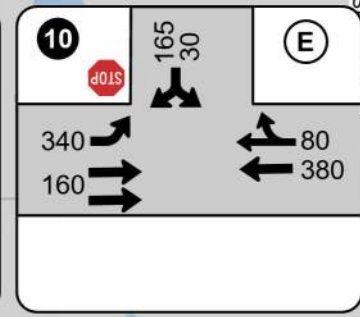
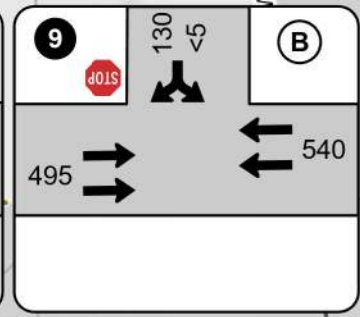
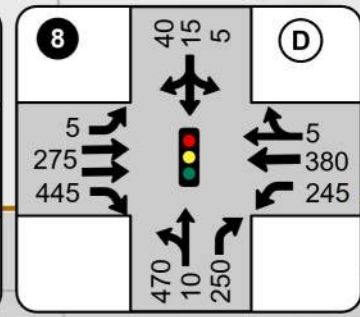
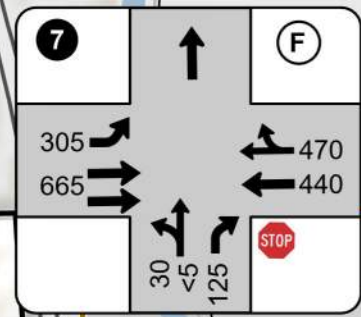
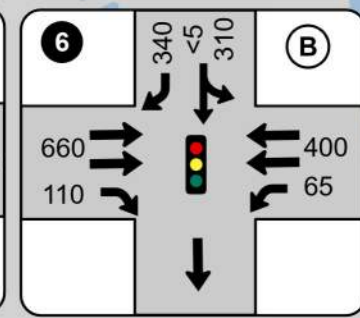
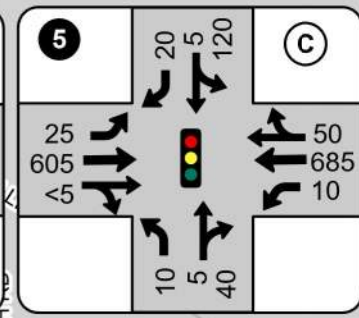
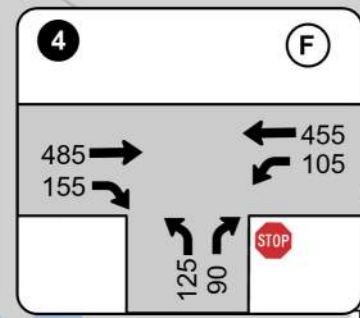
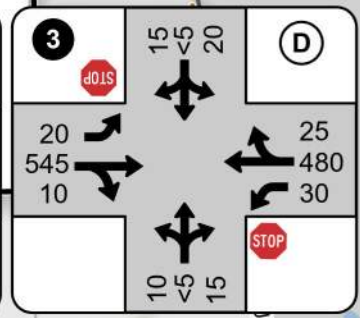
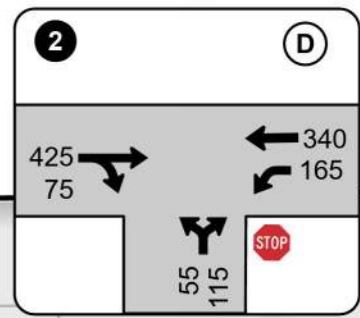
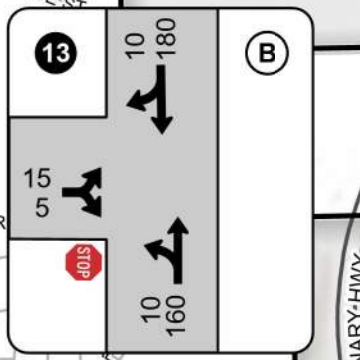
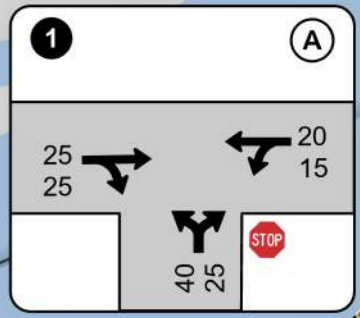
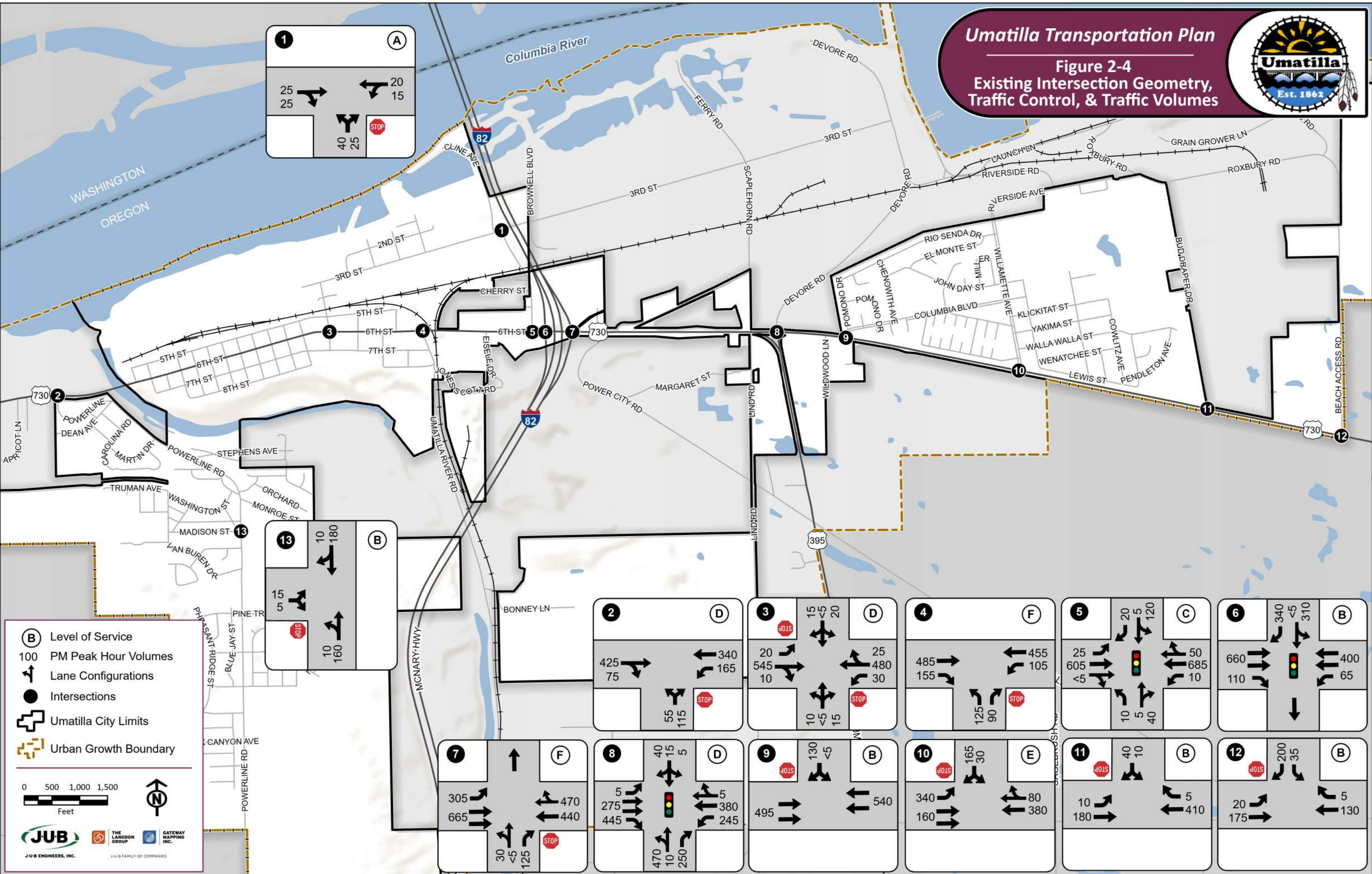

(B) Level of Service

100 PM Peak Hour Volumes

↔ Lane Configurations

● Intersections

⊕ Umatilla City Limits

⬡ Urban Growth Boundary

0 500 1,000 1,500 Feet

JUB J-U-B ENGINEERS, INC.

THE LANGDON GROUP

GATEWAY MAPPING INC.

inter-regional connectivity across I-82 for the City of Umatilla and surrounding land uses. Beyond these primary functions, the interchange provides an inter-regional connection that supports local, regional, and state business interests.”

Appendix A includes excerpts from the IAMP, including a list of recommended projects that includes the relocation of the POE, relocation of the intersection of Brownell Boulevard at US 730, signalization of the northbound I-82 ramps at US 730 as well as other improvements and an access management plan for the interchange. More recent comments from ODOT staff indicate that the implementation of some of the more costly relocation of the POE could potentially extend beyond the 20-year planning horizon and include innovations in IT.

2.4 Pavement Condition

In May 2022, J-U-B Engineers, Inc. collected data on different types and quantities of pavement distresses to analyze the existing condition of each paved road within the City of Umatilla limits and the Urban Growth Boundary. Data collection was based on the Pavement Data Collection (PDC) Manual (October 2021) while the subsequent calculations and pavement ratings were based on the State of Oregon GFP Pavement Condition Rating Manual (2010). The typical methods prescribed in these manuals involve recording the linear footage or number of distresses such as longitudinal cracking, fatigue cracking, transverse cracking, potholes, or pavement patches at a variety of severity levels as determined by specific criteria such as crack widths, pothole depths, fatigue crack patterns, etc. This data was then used in specific calculations that are based on the GFP Pavement Condition Rating Manual and the Computation of Indices in the State of Oregon 2020 Pavement Condition Report. The goal of these methods is to remove bias and subjectivity from the rating of each paved road by using empirical data to return a numerical index ranging from 0-100 which corresponds to a rating of Very Good, Good, Fair, Poor, and Very Poor.

The methods referenced above are typically employed by the State of Oregon Pavement Services Unit to rate the pavement conditions of the Oregon State Highway System. The data collection is primarily accomplished by this agency via a Pavement Condition Data Collection Vehicle (DCV) which is a truck equipped with computer, sensor and video equipment that automates much of the data collection. However, the Pavement Data Collection Manual allows for the collection of most data to be conducted manually if a DCV is not available. Furthermore, as this method was designed primarily for highways, the 0.1-mile sample measurement was modified in some cases where roads were not at least 0.1-mile long by projecting the length or combining a representative section with similarly conditioned roads located nearby. Lastly, measurements and calculations were based off two lane/travel directions as opposed to one-lane (as specified in the PDC Manual) to provide a wider sample of each road and account for variations in lane distresses.

The total length of roadway within the Urban Growth Boundary is 48.5 centerline miles. The number of miles that fall under each category of pavement condition are shown in the table below and graphically represented in Figure 2-5 Detailed pavement data collection for each roadway segment is provided in Appendix B.

Table 2-3 Pavement Condition Miles

Very Poor	Poor	Fair	Good	Very Good
11.5 miles	7.8 miles	12.3 miles	13.0 miles	3.9 miles
23.7%	16.1%	25.4%	26.8%	8.0%

Table 2-4 Good Fair Poor Pavement Rating Sheet

Rating	GFP	Stability	Structural Weakness	Fatigue	Transverse Block	Patching	Ride Qualities	Deformation and Rutting	Comment
Very Good	100 -96	Stable	None	None	None	None	Excellent	Rut depth less than 1/4"	Nothing would improve this road
Good	95 -80	Stable	None Evident	Generally Hairline and Hard to Detect	Minor amounts may be present	Minor amounts may be present	Very good	Deformation minor, rut less than 1/2"	May have dry or light colored appearance
Fair	75 -50	Generally Stable	Minor Areas Evident	Easier to Detect but Low Severity	May have widespread low and/or intermittent moderate severity	May be patched, but not excessively (i.e. less than 100%)	Good to acceptable	Deformation more easily noticed, rut less than 3/4"	Typ. Treatment need: Low vol.: chip seal High vol.: 2" resurface
Poor	45-25	Areas of Instability	Marked Evidence of Structural Deficiency	Large Crack Patters (Alligating) Present	May have widespread moderate and/or intermittent severity	Heavy and numerous	Acceptable to poor	Deformation very noticeable, rut 3/4" or g greater if present	Typ. Treatment need: Low vol.: 2" resurface High vol.: >2" resurface
Very Poor	20-5	Numerous Areas of Instability	Majority Showing Structural Deficiency	Intermittent to Extensive High Severity	Extensive high severity	Intermittent to extensive high severity	Unacceptable, should slow down		Typ. Treatment need: Low vol.: >2" resurface High vol.: heavy rehab or reconstruction

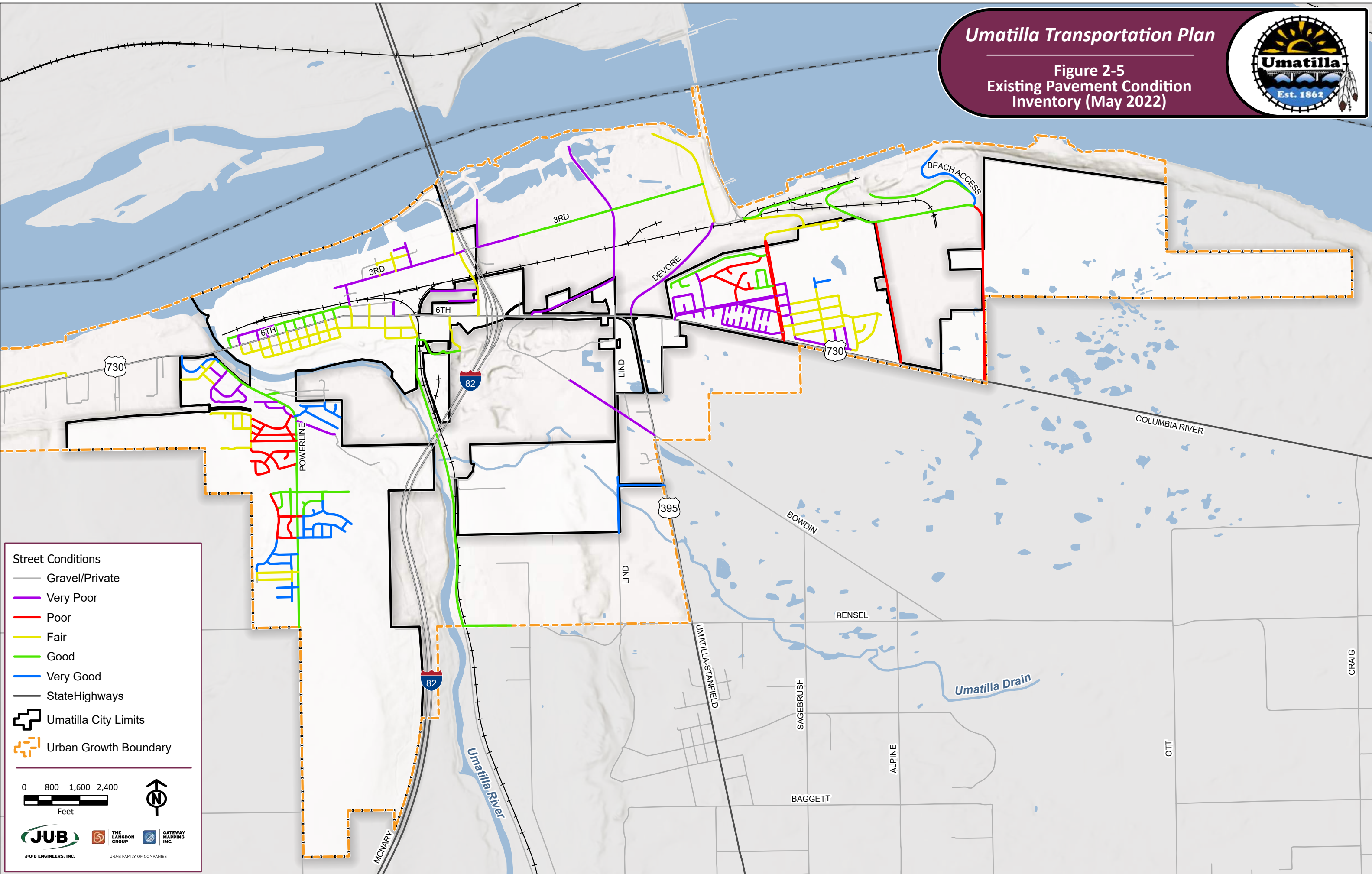

Street Conditions

- Gravel/Private
- Very Poor
- Poor
- Fair
- Good
- Very Good
- State Highways
- ⊕ Umatilla City Limits
- ⊞ Urban Growth Boundary

0 800 1,600 2,400
Feet



JUB THE LANGDON GROUP GATEWAY MAPPING INC.
J-U-B ENGINEERS, INC. J-U-B FAMILY OF COMPANIES

2.5 Traffic Volumes and Level of Service

Traffic volumes at study intersections were collected on Thursday May 19, 2022, from 4:00 – 6:00 PM, except for the intersection of Powerline Road/Madison Avenue which was collected on Thursday September 22, 2022. On US 730, the PM peak hour at US 395 and to the west was from 4:15 – 5:15 PM and east of US 395 it occurred between 4:00 and 5:00 PM. The two intersections that were evaluated that were not located on US 730, the PM peak hour occurred slightly later in the evening. The raw data collected is included in Appendix C.

Seasonal Adjustment Factors

Consistent with the methodology identified in the ODOT Analysis Procedures Manual (APM), 30th Hour Volumes for study intersections were developed using Automatic Traffic Recorder (ATR) data near the City of Umatilla that collect traffic data 24-hours a day, 365 days a year. Two ATRs are situated near the City, one on US 730 east of Umatilla and the other on I-84 just south of the Columbia River.

Data from the two ATRs for both the Average Daily and the Average Weekday conditions were gathered for purposes of comparison and are shown in Table 2-5.

Table 2-5 Seasonal Adjustment Factors

Month	2017	2018	2019	2020	2021	Average	Seasonal Adjustment
ATR 30-002 – US 730 0.24 miles east of OR 37 Average Daily							
Peak month (Aug)	144%+	121%	124%	95%*	N/A	123%	
Count month (May)	54%*	107%	112%	92%*	N/A	110%	1.118
ATR 30-002 –US 730 0.24 miles east of OR 37 – Average Weekday							
Peak month (Aug)	157%*	126%	124%	95%*	N/A	125%	
Count month (May)	55%*	110%	112%	92%	N/A	111%	1.126
ATR 30-025 – I-82 0.58 miles south of Columbia River -- Average Daily							
Peak month (Aug)	121%	117%	117%	125%*	116%*	118%	
Count month (May)	109%*	102%	109%	93%*	105%	105%	1.124
ATR 30-025 – I-82 0.58 miles south of Columbia River -- Average Weekday							
Peak month (Aug)	120%	115%*	120%	129%*	N/A	120%	
Count month (May)	109%*	102%	109%	99%*	N/A	106%	1.13

Note: Annual data shown by month is the percent of the Annual Average Daily Traffic for that month.

* Indicates values that were discarded from the average as indicated in the APM procedures.

Table 2-5 displays that average weekday volumes at both locations are slightly higher than Average Daily Traffic volumes. Using the Average Daily seasonal adjustment factors of both locations a combined factor results in 1.121 or a 12% increase in the traffic volumes collected in May to represent 30th Hour Volumes. The PM peak hour turning movement volumes collected in May were increased by 12% and rounded to the nearest 5 vehicles. The resulting traffic volumes are shown in Figure 2-4 above.

Traffic Operations Standards

The Oregon Highway Plan (OHP), Policy 1F, sets operational standards based on volume-to-capacity (V/C) ratios for various state highway categories. The V/C ratio targets for Non-Metropolitan Planning Organization areas are 0.80 for Interstate Highways, 0.85 for Freight Routes on a Regional or District

Highways, including US 730 and US 395 in the City of Umatilla. These standards apply to the overall V/C ratio at signalized intersections and to the state highway approaches at unsignalized intersections. The minor street approaches that are stop-controlled at intersections have a target V/C ratio of 0.90. The policy indicates that the peak hour shall be the 30th highest annual hour, hence the preparation of 30th hour volumes discussed above. This approximates weekday peak hour traffic.

The City of Umatilla Level of Service (LOS) standard for non-state-highway intersections, is based on the delay at intersections, consistent with the Highway Capacity Manual (HCM). The analysis of LOS is a means of quantitatively describing the quality of operational conditions of a roadway segment or intersection and the perception by motorists and passengers. Service levels are identified by letter designation, A – F, with LOS “A” representing the best operating conditions and LOS “F” the worst. Each LOS represents a range of operating conditions and one or more Measures Of Effectiveness (MOE’s) are used to quantify the LOS of a roadway element. For intersections the MOE used is average control delay in seconds per vehicle. While there are several methodologies for estimating the LOS of intersections, the most commonly used is presented in the HCM and is the methodology used in this study (HCM 6th Edition). The Highway Capacity Manual LOS criteria for intersections are summarized in Table 2-6.

Table 2-6 Level of Service Criteria for Intersections

Level of Service (LOS)	Average Control Delay (seconds/vehicle)	
	Signalized Intersections	Unsignalized Intersections
A	< =10	< =10
B	>10 - < 20	>10 - < 15
C	>20 - < 35	>15 - < 25
D	>35 - < 55	>25 - < 35
E	>55 - < 80	>35 - < 50
F	>80	>50

Source: *Highway Capacity Manual 6th Edition*, Transportation Research Board, National Research Council, Washington, D.C., 2017.

For unsignalized intersections, “delay” is based on the availability of gaps in the major street to allow minor street movements to occur. The methodology prioritizes each movement at an unsignalized intersection consistent with rules that govern right-of-way for drivers. In other words, major street through and right turn traffic has absolute priority over all other movements. Major street left turns must yield to opposing through traffic and right turns. Minor street through traffic and right turns yield to major street higher priority movements, and the minor street left turns have the lowest priority and must yield to all other movements. As traffic volumes increase, the availability of gaps will decrease and greater delay tends to result in driver frustration and anxiety, loss of time, unnecessary fuel consumption, and contributes to unnecessary air pollution. The City of Umatilla standard for Level of Service is LOS “D” for intersections, meaning the overall intersection LOS must be “D” or better for signalized intersections and the critical minor street approach for unsignalized intersection must be LOS “D” or better.

Port of Entry

The Interchange Area Management Plan (IAMP) made the following statements regarding the Port of Entry and weigh station situated north of US 730 and west of I-82.

The signalized intersections of Brownell Boulevard/US 730 and the southbound I-82/US 730 terminal are located within close proximity of one another resulting in undesirable operations. The signals have been coordinated in an effort to improve intersection operations. Nevertheless, queuing problems associated with truck traffic accessing the Umatilla Port of Entry (POE) weigh station continue to occur at the two intersections. This condition varies by season due to increase of trucks during mid-summer and fall harvests.

The Port of Entry and weigh station is located on the northwest corner of Brownell Boulevard/US 730 intersection which coincides with the northwest quadrant of the I-82/US 730 interchange. A truck stop, restaurant, fueling station and other commercial development is located in the southwest quadrant. East of the interchange is primarily vacant land within the City of Umatilla Urban Growth Area. This land is zoned exclusive farm use, tourism commercial or public facilities. The City is interested in the economic development potential of this area and would like to develop a local street network plan that supports the safe and efficient operation of the interchange and the US 730/US 395 intersection located within the interchange influence area. (I-82/US 730 IAMP, page 2, Problem Statement)

The IAMP also described the Weigh-in-Motion (WIM) operations at the Umatilla POE.

As was mentioned above, commercial truck traffic exiting I-82 to be weighed at the POE influences traffic operations in the interchange vicinity. Commercial truck traffic must be weighed when entering Oregon from another state. Historically, this has primarily occurred at weigh stations, which has required trucks to exit the mainline of the highway in order to be weighed. For trucks entering Oregon from Washington via I-82, this has occurred at the Umatilla POE. This process adds to the time it takes to transport goods, and in the case of Umatilla, contributes heavy truck traffic to the non-Interstate system. In order to facilitate this process and reduce its impacts, ODOT implemented the Oregon Green Light program in 1997. This program allows commercial truck drivers that register with the program and install the supplied transponder to weigh-in-motion on the roadway and bypass the off-system weigh station. Such a bypass exists on I-82 at Umatilla, which reduces the amount of truck traffic utilizing the POE. In September 2009, approximately 30,700 trucks were weighed at Umatilla, with approximately 14,300 trucks, or approximately 47% of all trucks, being granted a bypass by the Green Light system. These are trucks that would have otherwise had to stop at the Umatilla POE. Statewide, the use of the Oregon Green Light program is steadily increasing, with the number of trucks being granted bypasses increasing by nearly 20% from 2006 to 2009. ODOT staff expect use of the program to continue to rise until the industry is saturated. (I-82/US 730 IAMP page 40)

Data provided by ODOT for years 2019 – 2021 indicates that at the Umatilla POE serviced between 233,306 – 308,168 vehicles annually, with the number of vehicles being processed through Weigh-in-Motion ranging between 68,187 – 176,318 or 29% - 58%. It would appear that since 2009 that the percentage of vehicles being processed by WIM has grown, but the overall number of trucks has grown significantly as well, such that trucks continue to be a considerable factor in the traffic volumes in the vicinity of the POE. For example, the truck percentage for the I-82 southbound right turn movement during the PM peak hour

was 31% (94/304) while the eastbound right turn from US 730 to go southbound onto I-82 was 71% (69/97). The total PM peak hour truck percentage at the I-82/US 730 intersection was 14% (237/1685).

Traffic Operations Analysis

The Highway Capacity Software was used to evaluate stop-controlled intersections while Synchro software was used to evaluate signalized intersections. Existing lane configurations shown in Figure 2-4 were used with the 30th hour volumes also shown in the figure. Existing traffic signal timing plans at the 3 signals in the study area were obtained from ODOT. The results of the capacity analysis are shown in Table 2-7, with the capacity analysis worksheets included in Appendix D. Although different standards apply to different intersections, both delay, LOS and V/C are reported for comparative purposes. For the purposes of this analysis a V/C of 0.90 for the side street approaches to US 730 at unsignalized intersections will apply.

Table 2-7 Summary of Existing (2022) PM Peak Hour Delay and Level of Service

Intersection	2022 PM Peak Hour					
	Overall Intersection			Worst Approach		
	Delay	LOS	V/C	Delay	LOS	V/C
1. Brownell/Third	*			NB--9.3	A	0.09
2. Powerline/US 730	*			NB--20.5	C	0.44
3. Switzler/US 730	*			SB-- 29.0	D	0.23
4. River Road/US 730	*			NB--87.4	F	0.95
5. Brownell/US 730	20.2	C	0.43	SB--25.0	C	0.55
6. SB I-82 ramps/US 730	17	C	0.56	WB--22.0	C	0.35
7. NB I-82 ramps/US 730	*			NB--214.3	F	>2.0
8. US 395/US 730	53.1	D	0.68	NB--95.8	F	1.21
9. Columbia/US 730	*			SB--12.9	B	0.27
10. Willamette/US 730	*			SB--46.0	E	0.76
11. Bud Draper/US 730	*			SB--12.9	B	0.12
12. Beach Access/US 730	*			SB--10.9	B	0.29
13. Powerline/Madison	*			EB--10.9	B	0.04

LEGEND

60.8/E -- 0.05 Delay and Level of Service and V/C ratio using existing lane configurations

* Uncontrolled Movements (major street through) not provided for overall intersection Analysis for Two-way Stop Controlled Intersections

NB = northbound, SB = southbound, WB = westbound, EB = eastbound

The table above indicates that intersections 1 and 13, which are on the City streets, function well above standards. There are four intersections that currently function with poor LOS or high V/C ratios for the worst movement, however only two of those intersections exceed the ODOT V/C targets discussed above. The northbound I-82 ramp terminal at US 730 during the PM peak hour experiences significant delay and

has a V/C ratio over 2.0. The northbound approach of River Road also has an unacceptable V/C ratio at 0.95. The other two intersections that function with poor LOS either have an acceptable V/C ratio for the minor street approach, such as in the case of the Willamette Avenue intersection at US 730, or has overall intersection V/C that indicates it has available capacity in the signal cycle meaning that adjustments to the signal cycle could be made to reduce the delay for the worst approach as is the case at the US 395/US 730 intersection. The Willamette Avenue intersection southbound approach does not meet the City standard of LOS “D” for stop controlled intersections, indicating an improvement sooner rather than later is needed

2.6 Crash History

Between the years 2016 and 2020, there were a total of 214 vehicular incidents. Summary data is shown below in Tables 2-8 through 2-10, with Crash Frequency and Crash Severity being graphically shown in Figures 2-6 and 2-7. Crash history for the 214 collisions is included in Appendix E. There were no fatalities due to crashes in the 5-year period, with 87% of all incidents resulting in no apparent injury or possible injury. The most common collision types are as follows: Same direction, one stopped (23%), Entering at an angle (18%), and Fixed Object (14%). There were three intersections that had collisions involving pedestrians: Us 730 at River Road, “L” Street and Brownell Blvd. The intersection of I-82 and Highway 730 had the highest crash frequency within the City.

Table 2-8 Injury Type

Injury Type	Number	Percent
Suspected Serious Injury	5	2%
Suspected Minor Injury	24	11%
Possible Injury	57	27%
No Apparent Injury	128	60%
Total	214	100%

Table 2-9 Incident Type

Collision Type	Number	Percent
Same direction, one stopped	49	23%
Entering at an angle	39	18%
Fixed object	31	14%
Same direction, both going straight	24	11%
Parked motor vehicle	18	8%
Opposite direction, one straight, one left turn	17	8%
Opposite direction – all others	9	4%
Animal	5	2%
Same direction, one turn, one straight	5	2%
Same direction, all others	5	2%
Overturned	4	2%
Other object	3	1%
Pedestrian	3	1%
Other non-collision	2	1%
Total	214	100%

Table 2-10 Collision Type by Intersection

Intersection	Injury Type					Collision Rate*
	Suspected Serious Injury	Suspected Minor Injury	Possible Injury	No Apparent Injury	Total	
US 730/I-82 NB ramps	0	3	7	16	26	0.70
US 730/ I-82 SB ramps	0	4	5	12	21	0.67
US 730/Brownell Blvd	1	3	4	10	18	0.68
US 730/US 395	0	2	6	2	10	0.28
US 730/Willamette Ave	0	3	3	4	10	0.62
US 730/Eisele St	0	2	1	6	9	N/A
US 730/Columbia Blvd	0	3	0	3	6	0.31
US 730/Switzler Ave	0	1	1	3	5	0.25
US 730/Yerxa Ave	0	0	3	2	5	N/A
US 730/Bud Draper	0	0	1	3	4	0.37
Total	1	21	31	61	114	



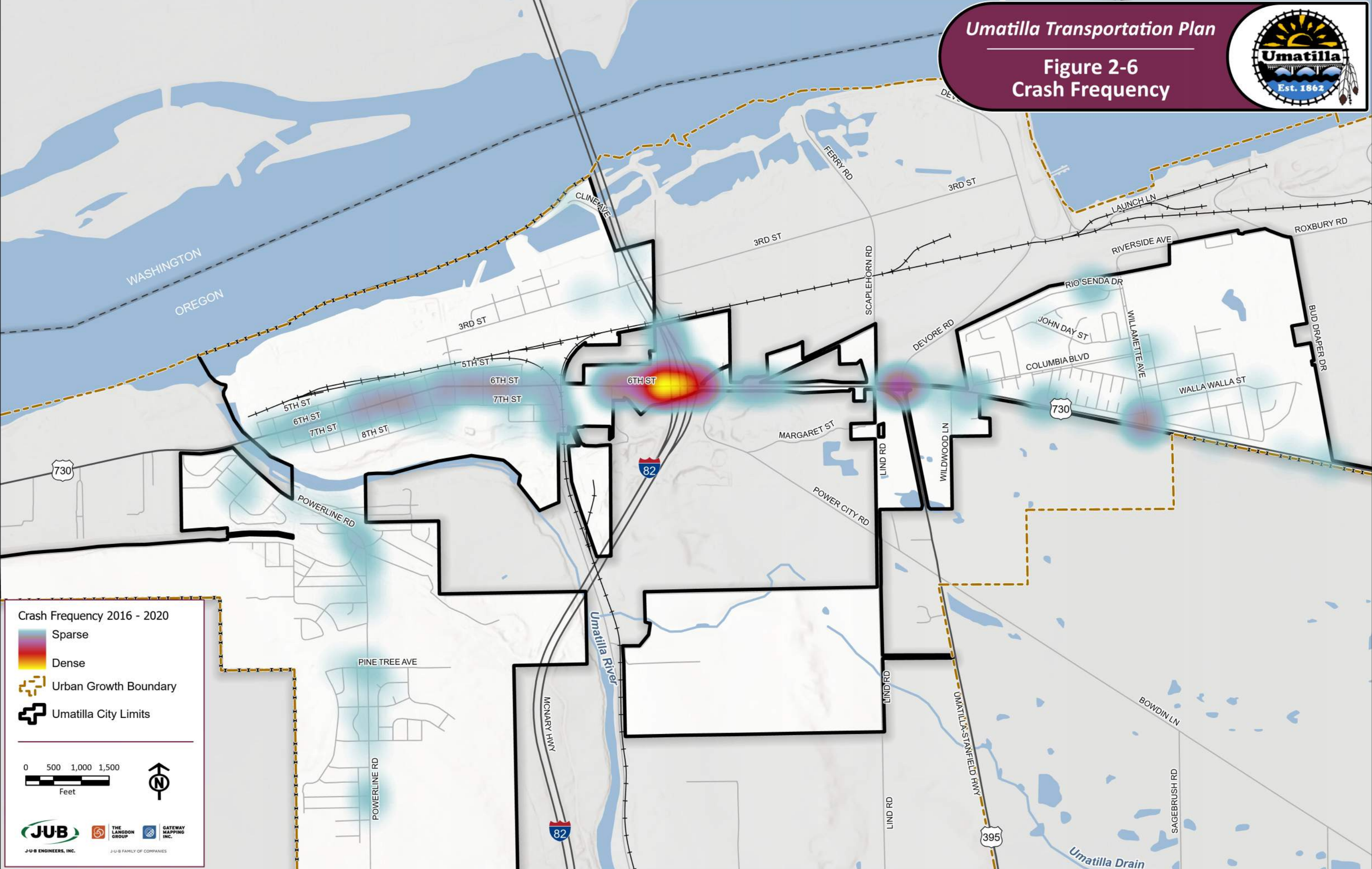

- Per Million Entering Vehicles, calculated using intersection volumes, with May PM peak hour volumes representing 10.9% of Annual Average Daily Traffic * 365 days/year * 5 years

The relatively low number of collisions compared to the traffic volumes calculates to collision rates less than 0.70 per million entering vehicles. This low rate combined with the fact that the intersections with the highest number will be considered for capacity improvements led the project team to not consider mitigation measures at this time. Safety improvements should be considered at the time of design for any capacity improvements.

Umatilla Transportation Plan
Figure 2-6
Crash Frequency

Crash Frequency 2016 - 2020

-  Sparse
-  Dense
-  Urban Growth Boundary
-  Umatilla City Limits

0 500 1,000 1,500
 Feet



JUB THE LANGDON GROUP GATEWAY MAPPING INC.
 J-U-B ENGINEERS, INC. J-U-B FAMILY OF COMPANIES

Umatilla Transportation Plan
Figure 2-7
Crash Severity (2016 - 2020)

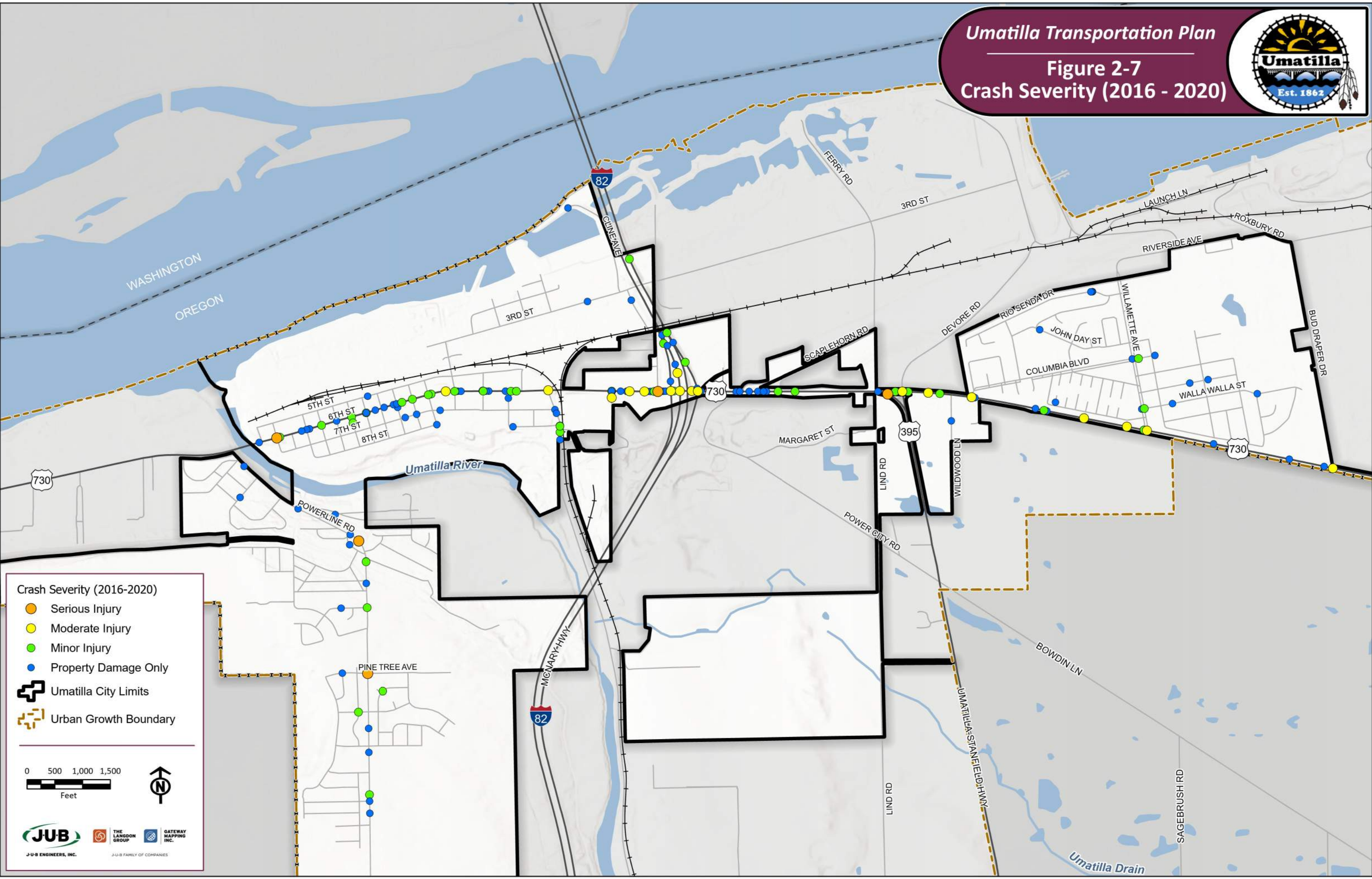

- Crash Severity (2016-2020)**
- Serious Injury
 - Moderate Injury
 - Minor Injury
 - Property Damage Only
 - Umatilla City Limits
 - Urban Growth Boundary

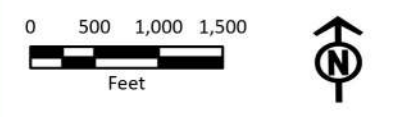

Chapter 3 - Other Modes of Transportation

3.1 Bicycle and Pedestrian Facilities

Umatilla Trails Master Plan

The City of Umatilla developed and adopted a city-wide trail plan in February 2020. The goal of the trail plan is to create a system of trails that serve as an alternative to motorized transportation, that enhance public health and foster the development of a premier outdoor recreation experience and destination for tourism. The Trail Plan serves as a concept for future development, improvement, and management of the proposed and existing network of trails, pathways and sidewalks in the City.

Umatilla’s unique location at the confluence of the Umatilla and Columbia Rivers, together with the desire of City Council and residents to enhance livability and walkability and the relatively moderate climate, positions the city to become one of eastern Oregon’s premier park and recreation destinations. With rich history shaped in part by transportation, Umatilla is ideally located within the region at the confluence of two rivers and the intersection of two interstate systems. The rivers have been significant since Native American tribes first inhabited the land since time immemorial. The highways, Interstate 82 and Highways 730 and 395 are significant regional freight and vehicle facilities. Today, Umatilla continues to be a transportation hub for trade and is dominated by infrastructure for automotive, railroad, and river transportation of people and goods.

The Umatilla Trail Plan builds upon the foundation of previous planning efforts to improve non-automotive transportation in Umatilla and to support exercise, outdoor recreation and tourism. The City hosted a variety of opportunities for public involvement, both formal and informal (paper and online surveys with Umatilla School District students and City Parks & Recreation Committee hosted Open House). Less traditional outreach was implemented to include the diverse population, such as translating documents to Spanish, providing translators at public engagement events, etc.

Over a two-year period, an inventory of existing facilities was conducted. In total, the trail network consists of 34 miles of trails that are owned and maintained by a number of local, state and federal agencies. The trails consist of varying surface materials suitable for different modes of transportation. Segments of trails located outside of the Urban Growth Area connect to the City and are an important part of the regional trails system. This inventory also identified approximately 17 miles of sidewalk within the city limits, compared to the 55 linear miles of streets (excluding HWY 395, HWY 730 and I82). Potential trail connections were evaluated based on how they would improve the walkability between “pedestrian generators”, otherwise known as locations, that attract high traffic of walkers and/or bicyclists, such as food and convenience stores, check, city-owned parks, schools, etc.

The Umatilla Trail Plan is primarily conceptual but also includes varying degrees of detail, understanding that specific projects will require refinement plans for design and engineering, as well as a strategy for funding and capital improvement. The development of a trail plan created an opportunity to rethink the purpose of transportation as a means of commuting with vehicles but also for pedestrians and bicyclists. By prioritizing trails, streets will be viewed for multiple purposes, for both pedestrians and bicycles as well

as for automobiles and trucks. Streets are valuable infrastructure which can serve a dual purpose for bicycles and pedestrians if designed accordingly.

The city sees 11 major projects that will result in a trail system that connects the three regions of the City: McNary, Downtown and South Hill. The existing trail network and proposed projects are shown in Figure 3-1. The Trail Plan is designed to connect the City trail system with the west Umatilla County Umatilla River Trail, the Morrow County Heritage Trail and the Lewis & Clark Trail. The community was invited to prioritize the projects, one for each of the three regions in the City: South Hill, Downtown and McNary. The community ranked project #1, “South Hill Connector” for the South Hill Region, project #11, “Marina to Umatilla Landing Park” for the Downtown Region and, project #3 “McNary Connector” was ranked highest for the McNary neighborhood. Accordingly, upon adoption of this plan, City staff will make it a priority to secure funding for these three projects. However, as explained during the community meetings, other projects may be constructed earlier if opportunities for funding arise. Examples include project specific grant criteria, projects funded directly by new development or conservation grants that would combine habitat restoration and trail construction.

The 11 trail projects identified in the Umatilla Trail Plan will be developed over the next 5 – 10 years as funding becomes available and as other development and improvement opportunities arise. The projects are designed so they can be either stand-alone projects or developed in tandem or as part of other capital improvement projects. Pages from the Master Trails Plan depicting the trails system and the 11 projects are included in Appendix A.

Pedestrian & Bicycle Master Plan





In 2003 the City adopted the Pedestrian & Bicycle Master Plan. This Plan identified sources of non-motorized traffic generators and provides an extensive inventory of street system, pedestrian and bicycle facilities. It identifies development code standards and potential funding sources. The Plan presents a neighborhood analysis and project evaluation criteria for four geographic areas: South Hill, Downtown, Central and McNary and summarizes projects in a Capital Improvement Program. More details are provided in Appendix A.

Other Efforts

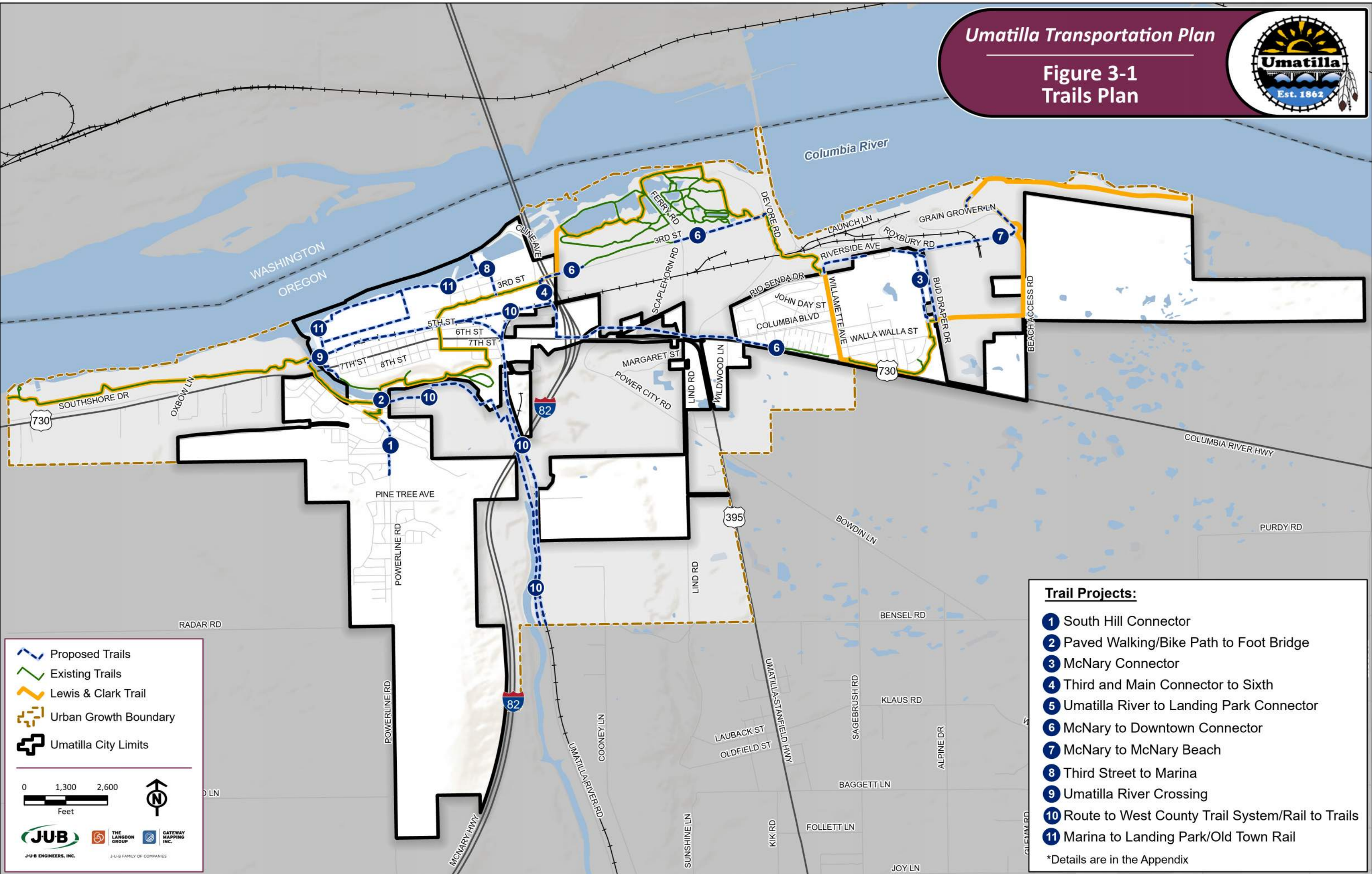
The pedestrian bridge over the Umatilla River was damaged a few years ago and rendered unusable. The City has secured funding to replace the bridge which is anticipated to occur in 2023. The City is also in the process of designing an improved connection to Powerline Road to the new bridge that will facilitate trips from the South Hill area to the downtown and especially school trips.

The City of Umatilla also worked with several jurisdictions to create the Umatilla River Trail adopted in 2021. The Plan discusses the benefits of a trail, interpretive opportunities, types of trail and provide detailed maps of Umatilla River trail segments stretching from the City of Echo to the Columbia River. It addresses signage and wayfinding, sign types, trail environments, trailheads, public art, fencing and lighting as well as road crossing and trail management. Pertinent pages to the portions of the trail in the City of Umatilla are included in Appendix A.



 Proposed Trails
 Existing Trails
 Lewis & Clark Trail
 Urban Growth Boundary
 Umatilla City Limits

0 1,300 2,600
 Feet



 THE LANGDON GROUP GATEWAY MAPPING INC.
 J-U-B ENGINEERS, INC. J-U-B FAMILY OF COMPANIES

- Trail Projects:**
- 1** South Hill Connector
 - 2** Paved Walking/Bike Path to Foot Bridge
 - 3** McNary Connector
 - 4** Third and Main Connector to Sixth
 - 5** Umatilla River to Landing Park Connector
 - 6** McNary to Downtown Connector
 - 7** McNary to McNary Beach
 - 8** Third Street to Marina
 - 9** Umatilla River Crossing
 - 10** Route to West County Trail System/Rail to Trails
 - 11** Marina to Landing Park/Old Town Rail
- *Details are in the Appendix

3.2 Transit

Public transportation within the City of Umatilla is limited to Kayak Public Transit. Kayak is operated by the Confederated Tribes of the Umatilla Indian Reservation and is providing Commuter Bus Routes, Fixed Routes, and ADA Paratransit service to 14 cities and 4 counties as a free rural regional transportation system reaching into southeastern Washington and northeastern Oregon. Kayak currently has 8 stops located within the City of Umatilla (see Figure 3-2). See Table 3-1 below for arrival and departure times.

Table 3-1 Kayak Umatilla Service





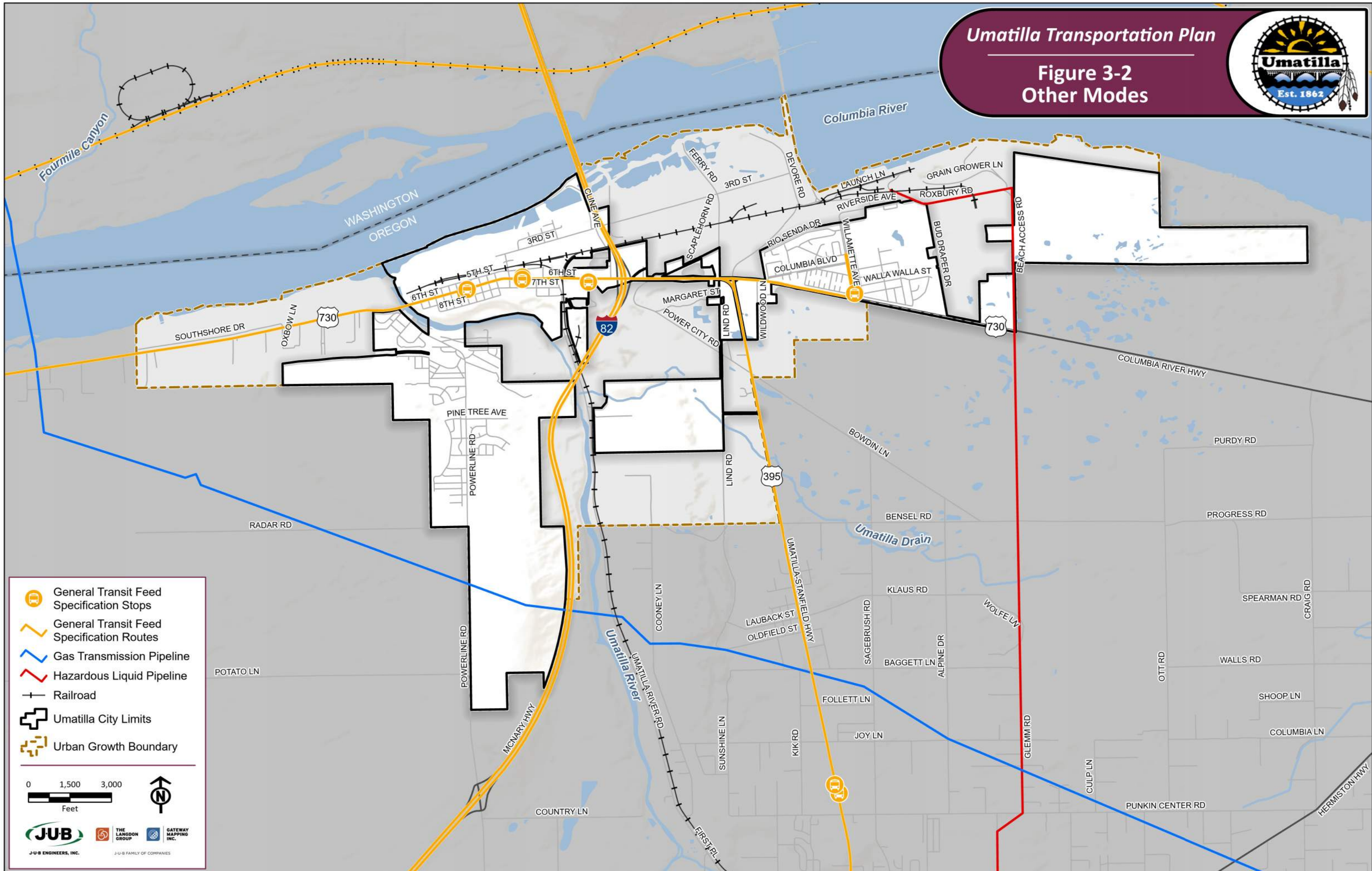

Bus Stop Location	AM	Mid AM	Mid PM	PM	Sat AM	Sat PM
McNary Market (205 Willamette St)	--	9:41 AM	2:17 PM	6:31 PM	9:52 AM	4:52 PM
Umatilla Recycle Depot (6 th Street & Yerxa Ave)	--	9:45 AM	2:23 PM	6:37 PM	9:58 PM	4:58 PM
6 th St & B St	--	10:00 AM	2:27 PM	--	10:02 PM	5:02 PM
6 th St & Village Square	--	10:21 AM	2:48 PM	6:39 PM	10:22 AM	5:22 PM
6 th St & Yerxa	--	10:21 AM	2:49 PM	--	--	--
Umatilla Post Office (1900 6 th St)	6:04 AM	10:23 AM	2:51 PM	6:42 PM	10:25 AM	5:25 PM
Arrive McNary Market (205 Willamette St)	6:08 AM	10:28 AM	2:56 PM	--	10:30 AM	5:30 PM
Depart McNary Market (205 Willamette St)	6:08 AM	--	--	--	10:43 AM	5:43 PM

The City of Umatilla no longer has Greyhound services. The nearest Greyhound stop is located in Stanfield at the Pilot Travel Center (2115 S Highway 395, Stanfield, OR 97875).

The City supports other efforts in improving transit service within the City and connections to services in Hermiston. To support the provision of transit services the City of Umatilla intends to undertake a more detailed evaluation of potential transit services and appropriate ways to serve both residents and the workforce. These services could include:

- A local route that connects the city as a whole, for example connecting South Hill residential to employment opportunities in the northeast portion of the City
- Improved connections to regional service
- Service to the Project PATH transitional housing facility
- Park and Ride facilities
- Improved multi-modal connections



-  General Transit Feed Specification Stops
-  General Transit Feed Specification Routes
-  Gas Transmission Pipeline
-  Hazardous Liquid Pipeline
-  Railroad
-  Umatilla City Limits
-  Urban Growth Boundary

0 1,500 3,000
Feet



JUB THE LANGDON GROUP GATEWAY MAPPING INC.
J-U-B ENGINEERS, INC. J-U-B FAMILY OF COMPANIES

3.3 Rail

Union Pacific Railroad operates a local freight rail line through portions of the City of Umatilla. The “Umatilla Turn” connects local manufacturers with Union Pacific’s Hinkle Yard and main rail trackage to the south in Hermiston. From Umatilla, the rail line travels south roughly parallel to Umatilla River Road until reaching downtown Hermiston, where the line turns to the southwest and travels towards Union Pacific’s main facilities at the Hinkle Rail Yard.

Because the rail line terminates along the banks of the Columbia River at the Port of Umatilla, it is operated as a spur and the frequency of freight trains varies based upon demand. Currently, service is provided on Mondays, Wednesdays, and Fridays during the evening hours. Typically, trains depart Hermiston for Umatilla at approximately 2:30 PM and arrive in Umatilla between 5:00 PM and 8:00 PM, depending on the number of local switching operations in route. The frequency of trains can be increased should shipping demand warrant additional service in the future.

There are six public at-grade rail crossings: Switzler Avenue and Brownell Blvd west of I-82, with Devore Road, Deschutes Avenue and Bud Draper east of I-82 crossing the east-west track and Jones Scott Road crossing the north-south track. There is also a private crossing of Jane Street serving the South Basin Packing parking lot north of US 730.

3.4 Air

No commercial or private aviation facilities are located within the City of Umatilla. Regional freight cargo and air passenger services are provided at the Eastern Oregon Regional Airport in Pendleton, located approximately 35 miles southeast of Umatilla via I-84 and in Pasco, Washington, located approximately 30 miles to the north. Both the Eastern Oregon Regional Airport and the Tri-Cities Airport provide regional passenger air service, connecting to national and international air service at the Portland International Airport and the Seattle-Tacoma International Airport. In addition, the City of Hermiston owns and operates a general aviation municipal airport. Hermiston’s airport does not offer commercial flights, but charter service is available, and several local businesses make use of the facility. The airport provides facilities for crop dusting aircraft that serve farmers/foresters in the area.

3.5 Water

The Columbia River borders the City of Umatilla to the north and serves as a means of transportation for both commercial and recreational traffic. The McNary Dam, operated by the U.S. Army Corps of Engineers, is located approximately one mile east of Interstate 82 and serves both commercial barge traffic and recreational boats traveling along the Columbia River past of City of Umatilla.

The Port of Umatilla maintains two marine facilities along the Columbia River. The Umatilla Marina Park, located immediately west of Interstate 82, is located on property owned by the U.S. Army Corp of Engineers, though the marine facilities are operated and maintained by the Port. Approximately 124 slips are available at the marina as well as a boat launch ramp, a fueling dock, a 38-space recreational vehicle parking area, and restroom facilities.

The second marine facility operated by the Port is located on the east side of the McNary Dam and is used for commercial cargo handling purposes. A container terminal (shallow draft/barge dock) at this location is used to transfer containerized frozen potatoes using a 50-ton crane. Weekly barge service is provided to the area for potato shipments and electrical service is available at the docks to support up to 100

refrigerated containers. In addition, Pendleton Grain Growers operate a grain transfer facility and Tidewater Terminal Company operates a tank farm that provides for liquid fertilizer and fuel transfers. The port also serves as a terminal for transferring diesel fuel to a pipeline owned by Kaneb Pipeline Corporation, which in turn supplies Hinkle Rail Yard. The marine facilities at the port have access to rail service provided by Union Pacific, via the “Umatilla Turn.”

Although recreational river traffic is generally limited to private vessels operating in the area, river cruise lines call at the Umatilla Marina Park for tourist related activities. Typically, the river cruise ships dock so that passengers can travel to Pendleton or Patterson to partake in regional tourist attractions. The Umatilla Marina Park is not considered a base of operations for the river cruise lines and does not serve as an origin for their trips.

3.6 Pipelines

Two hazardous pipelines travel through the City of Umatilla. A high-pressure natural gas pipeline corridor has two pipes that cross the Columbia River west of the City and turns to the east, crossing the southern part of the City. A hazardous liquid diesel pipeline that services the Hinkle Railyard runs north/south through the City and ends at the Tidewater Terminal and the Columbia River. These pipelines are shown in Figure 3-2.

Land adjacent to the hazardous pipelines, previously farm and agricultural land, is now zoned for residential, industrial, and commercial development. The hazardous liquid pipeline crosses Hwy 730, a major agricultural route for farmers and ranchers and recreational fishing on the river and is also central to expanding business and new residential development. Along US 730 adjacent to the pipeline crossing is tribal land known as the Wanaket Wildlife Mitigation Area, managed by the Confederated Tribes of the Umatilla Indian Reservation and includes Bonneville Power Administration mitigation easements for McNary Dam. The Tidewater Terminal sits on the Columbia River at the end of the hazardous liquid pipeline and houses large amounts of fertilizers and other hazardous materials. The high-pressure natural gas pipeline also crosses Interstate 82 and US 395, which are regional transportation corridors.

The City recently was awarded a Technical Assistance Grant from the U.S. Department of Transportation (US DOT) Pipeline and Hazardous Materials Safety Administration (PHMSA) to understand the locations of the hazardous pipelines in relation to the City’s infrastructure, recreation, and transportation corridors will help the City of Umatilla address other issues they face, such as:

Safety:

- Create best management practices for city staff and inform and educate visitors, residents, farmers, and contractors about evacuation plans and the importance of contacting 811 to have utilities marked before beginning any projects.
- By completing a pipeline safety assessment, which includes determining evacuation routes and evacuation zones, they will have a plan and an understanding that they have not had in the past.

Equity:

- All residents will be safer with precise pipeline mapping in the event of a hazardous pipeline incident regardless of income level, transportation/evacuation options, or physical ability.

Climate Change:

- Minimize the effects of climate change by reducing the risk of a pipeline incident or leakage of hazardous materials into the air, soil, culinary water sources, the Columbia River, and nearby agriculture and livestock.

Challenges Facing Rural Transportation Networks:

- The City of Umatilla has two main roadways in and out of the City. Interstate 82 runs north/south connecting Umatilla to Interstate 84 to the south (a major highway through northern Oregon connecting Boise & Portland) and Kennewick to the north, which offers many employment opportunities. Hwy 730 connects the City to Irrigon to the west, and Hwy 395 is a critical connection to the nearest hospital in Hermiston to the south. These connection roads are essential to the safety and economic well-being of the people of Umatilla. A natural disaster or hazardous pipeline incident would impact the City's ability to have safe emergency access. It could have long-lasting economic impacts due to the lack of transportation options for the movement of people, goods, and services into and out of the City.

The intent of the project is to foster open communication with operators, City officials, public works staff, schools, medical facilities, and emergency personnel in a collaborative approach to pipeline safety. The City will continue to work closely with the pipeline operators, Northwest Pipeline, LLC., and Tidewater, Inc. to share information regarding the pipeline locations and attributes, emergency information and protocols, develop an evacuation plan and attend meetings as necessary. As part of the project, the City plans to hold a meeting with the pipeline companies, City staff, police department, and emergency response teams and connect with the schools and Umatilla County Emergency Response personnel to share and discuss the findings of the pipeline safety assessment.

Chapter 4 - Future Conditions

4.1 Future Population

The Coordinated Population Forecast for Umatilla County produced by Population Research Center at Portland State University indicates a forecast population growth from 7,363 in 2020 to 9,300 by year 2030 and 10,824 by year 2045. This calculates to a rate of 2.36% per year from 2020 – 2030, but an average annual rate of 1.55 percent from 2020 – 2045 for the City of Umatilla.

4.2 Anticipated Development

There has been significant activity and interest for residential and industrial development in the South Hill area off Powerline Road as well as for industrial development towards the east end of the City off Beach Access Road. The City has also recently expanded the Urban Growth Boundary to the south west of Powerline Road as well to accommodate industrial development interest. This expansion also involved changing some of the land use designations in the Comprehensive Plan to industrial uses. A new elementary school is also to be constructed in the South Hill area west of Powerline Road and north of Grant Street. Based on recent activity from developers for both residential and industrial uses, the City of Umatilla staff prepared the map shown as Figure 4-1 that indicates areas of anticipated growth.

4.3 Design Standards

The City of Umatilla has established design standards for public works construction projects that guide the development and redevelopment of roads within the City.

Roadway Design Standards

City adopted design standards are currently being reviewed to remove optional features such as two-way left turn lanes, planter strips, bike lanes and sidewalks to have them apply to appropriate functionally classified roads. The design standards with typical sections for arterial, collector and local streets can be requested from the City Engineer. ODOT has its own design standards as well.

Access Management

Access management is an important tool for maintaining a transportation system. Too many access points along arterial streets lead to an increased number of potential conflict points between through vehicles and vehicles seeking ingress/egress at driveways on the arterial streets. This not only leads to increased vehicle delay and a deterioration in the level of service on the arterial, but also leads to a reduction in safety. Research has shown a direct correlation between the number of ntss points and collision rates. Experience throughout the United States has also shown that a well-managed access plan for a street system can minimize local cost for transportation improvements needed to provide additional capacity and/or access improvements along unmanaged roadways. Therefore, it is essential that all levels of government maintain the efficiency of existing arterial street through better access management. Recommended access spacing are shown in Table 4-1.

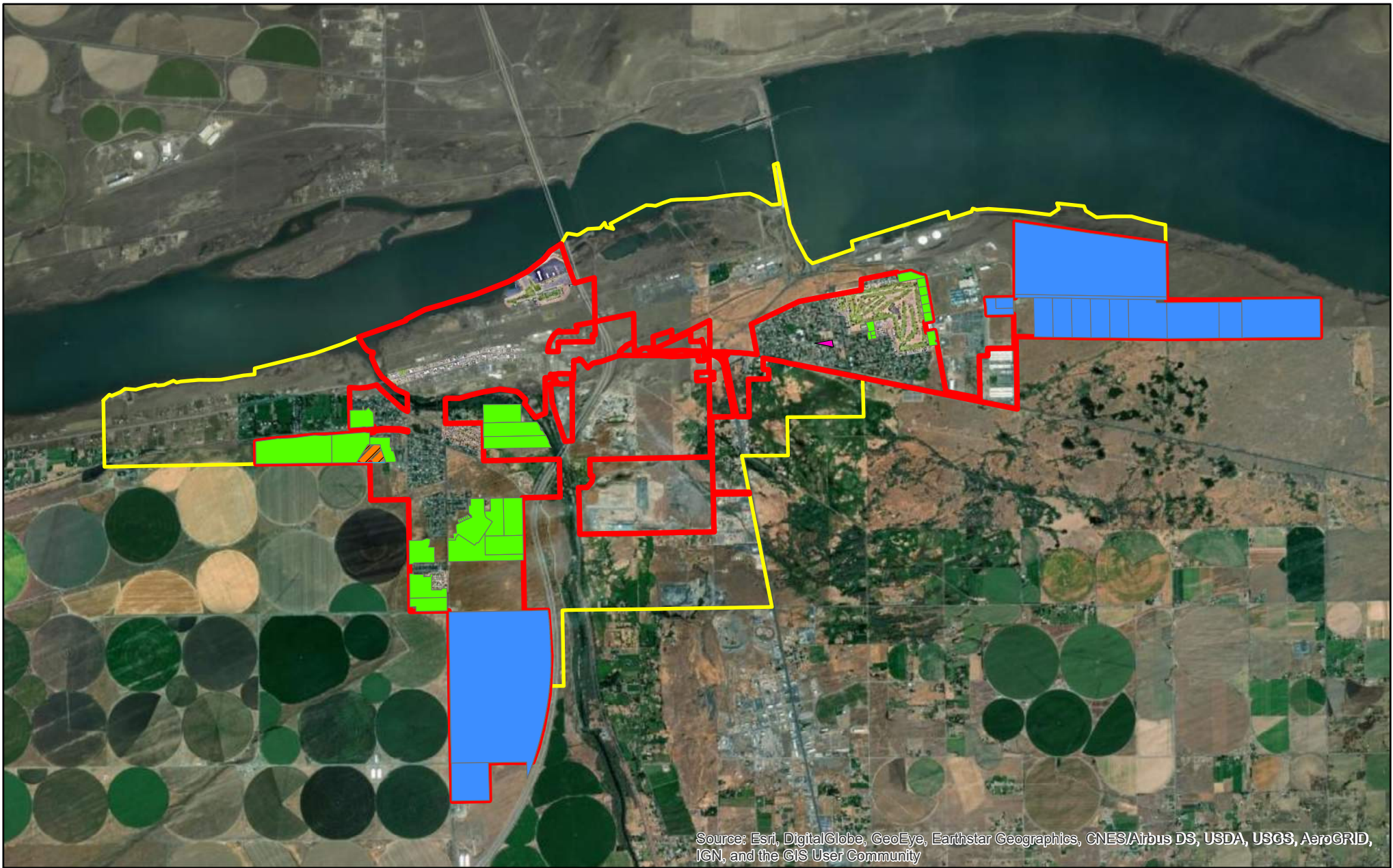





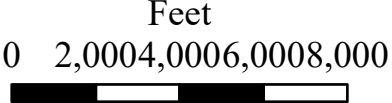

Source: Esri, DigitalGlobe, GeoEye, Earthstar Geographics, CNES/Airbus DS, USDA, USGS, AeroGRID, IGN, and the GIS User Community

ANTICIPATED DEVELOPMENT WITHIN CITY OF UMATILLA



Legend

- | | | | | | |
|--|-------------|---|------------|---|-----------------------|
|  | Residential |  | New School |  | City Limits |
|  | Industrial |  | Commercial |  | Urban Growth Boundary |

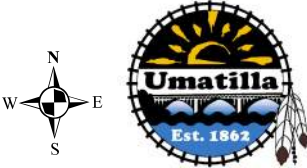

MAP DISCLAIMER: No warranty is made as to the accuracy, reliability or completeness of this data. Map should be used for reference purposes only. Not survey grade or for legal use. Created by Jacob Foutz, on 4/14/2022

Table 4-1 Recommended Access Management Standards

Functional Classification	Intersections			
	Public Road		Private Drive ⁽²⁾	
	Type ⁽¹⁾	Spacing	Type ⁽¹⁾	Spacing
Arterials ⁽³⁾	at-grade	250 ft.	L/R turns	100 ft.
Collector	at-grade	250 ft.	L/R turns	100 ft.
Residential Street	at-grade	250 ft.	L/R turns	Access to each lot
Alley (Urban)	at-grade	100 ft.	L/R turns	Access to each lot

1. For most roadways, at-grade crossings are appropriate.

2. Allowed moves and spacing requirements may be more restrictive than those shown to optimize capacity and safety. Any access to a state highway requires a permit from the ODOT District Office. Access will generally not be granted where there is a reasonable alternative access.

3. ODOT has statewide standards for specific facilities and for freeway interchange spacing.

US 730 has established specific access spacing standards:

- From the Umatilla River Bridge to I-82 northbound ramp, minimum spacing of public streets is 500, for private driveways is 150, with signal spacing of one-quarter mile.
- From the I-82 northbound ramps to the east city limits is one-half mile spacing for public streets, 500 feet for private driveways and one-half mile for traffic signal spacing.

Traffic Impact Analysis

The City of Umatilla requires a Traffic Impact Analysis be performed for developments that will add more than 250 trips per day to the roadway network. The guidelines for preparation of TIA are included in Appendix G.

4.4 Traffic Volume Forecasts

In order to assess the study intersections for future capacity needs, a 20-year forecast needed to be prepared. Initially, since many of the study intersections were the same as those studied for both the 1999 TSP as well as the 2011 Interchange Area Management Plan (IAMP), a comparison was made of those traffic volumes (both then existing and the forecasted future) to those collected for the preparation of this TSP. Some significant anomalies were noticed, mainly that on US 730, the westbound volumes during the PM peak hour were actually lower than volumes 25 years prior. The TAC discussed potential reasons for why this may have occurred, including changes at the ODOT weigh-station and delay at the northbound I-82 off-ramp and that traffic may be using other routes. Because of this anomaly, this makes using growth rates at each intersection inappropriate.

This forecasting methodology for the TSP study intersections involved the following steps:

1. The City has had multiple residential plats submitted for review on the South Hill that accesses Powerline Road. Also, the Urban Growth Boundary was expanded and rezoned to industrial. This proposed development represents nearly 1000 homes. The studies were done independently during the development approval process. These studies were reviewed to determine the cumulative effect and it was assumed that 25% of the industrial work trips might live in these new homes. These trips were then distributed through the network on US 730 assuming existing traffic patterns and percentages of traffic turning at the various intersections.

2. City staff also indicated that three additional data center type facilities are being pursued that would use Beach Access Road to US 730 at the east end of the City. Existing trips going into and out of Beach Access Road were used to estimate future trips and these trips were distributed to the network using existing traffic patterns and percentages of traffic turning at the various intersections to the west.
3. The ATR data referenced earlier that was used to determine seasonal adjustments was used to determine historical growth rates. Year 2021 data was exceptionally high and was not felt to be representative when looking at historical trends. Year 2020 data appeared to have Covid related travel restriction characteristics. When looking at the 20 years prior, from 1999 – 2019 the growth rate was approximately 1.5% annually. The entering and departing traffic on the state highways displayed that the entering traffic for the study area was increased by this percentage and then volumes between intersections were balanced through the network to reasonably match existing patterns of traffic entering and exiting the network internal to the US 730 corridor.

This methodology was discussed with the ODOT Transportation Planning Analysis Unit. The Oregon Statewide Integrated Model (SWIM) was used, and it was verified that the resulting traffic volumes forecast were similar to those in the SWIM. The resulting traffic volumes for the year 2043 are shown in Figure 4-2.

4.5 Traffic Operations Analysis

Capacity analysis was performed using the PM peak hour traffic volumes (shown in Figure 4-2) and the existing intersection lane configurations. Signal timing adjustments were made to the three existing traffic signals to minimize delay and efficiently use available capacity at the intersections. The results of the analysis are shown in Table 4-2 with Capacity Analysis worksheets included in Appendix H.

Examination of Table 4-2 shows that over half of the study intersections are anticipated to fall below acceptable standards by the year 2043 if the traffic forecast volumes are achieved. In addition to the I-82 northbound ramp terminal at US 730 and the River Road/US 730 intersection, it is anticipated that the Powerline Road, US 395, Willamette Road and Beach Access Road intersections with US 730 will need improvements in order to serve the forecast traffic volume. The Powerline Road/Madison Avenue intersection will also need improvements. Potential improvements and the timing for them are discussed in the Alternative Analysis chapter along with potential phasing.

Umatilla Transportation Plan

Figure 4-2 2043 Traffic Forecasts

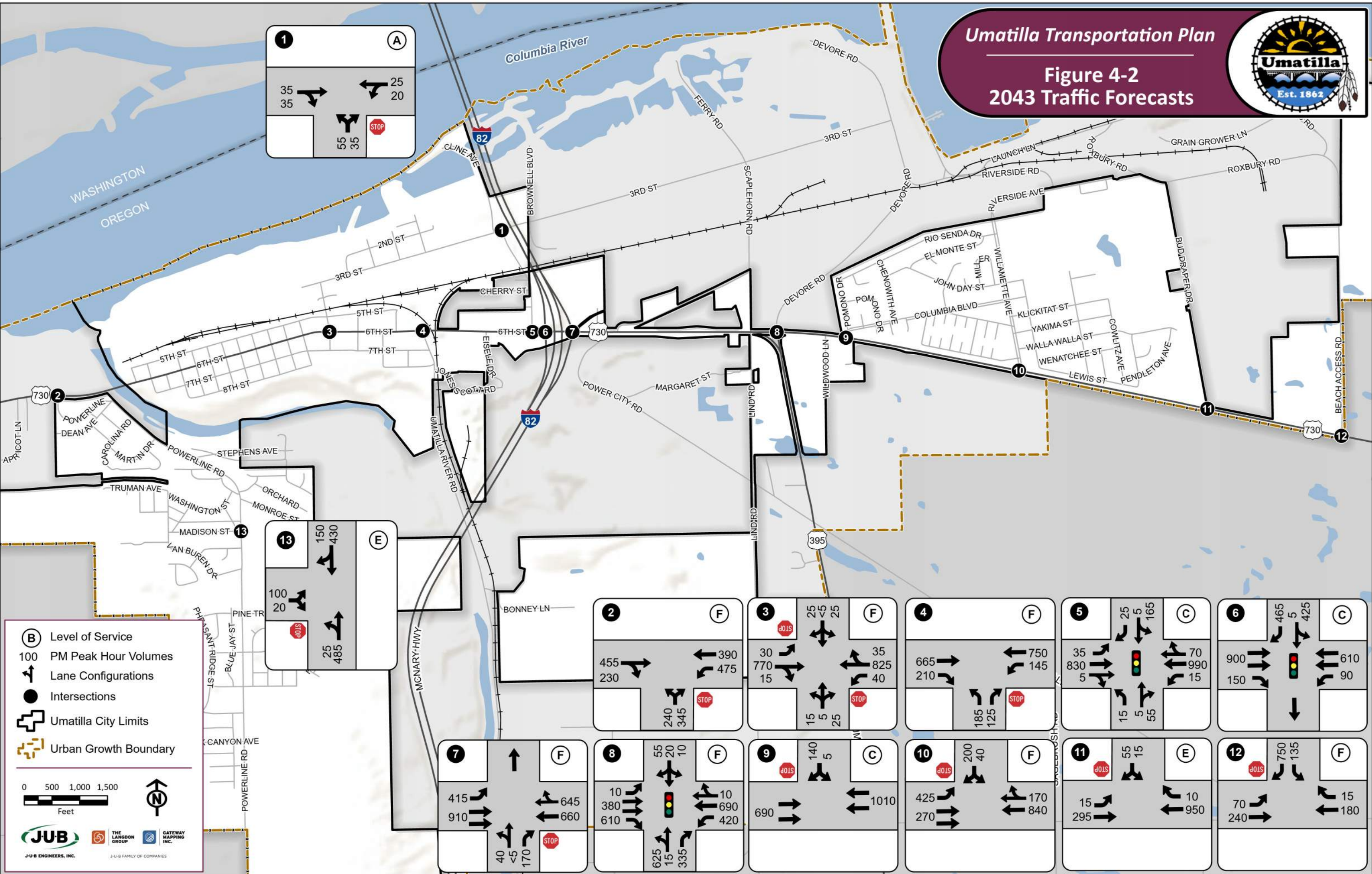
1 **A**

35	←	25
35	→	20
	↑	STOP
	↓	55
		35

13 **E**

100	←	150
20	→	430
	↑	STOP
	↓	25
		485

2 **F**

455	←	390
230	→	475
	↑	STOP
	↓	240
		345

3 **F**

30	←	25
770	→	<5
15	↑	STOP
	↓	25
		35
		825
		40

4 **F**

665	←	750
210	→	145
	↑	STOP
	↓	185
		125

5 **C**

35	←	25
830	→	5
5	↑	STOP
	↓	15
		5
		165

6 **C**

900	←	465
150	→	5
	↑	STOP
	↓	425
		610
		90

7 **F**

415	←	645
910	→	660
	↑	STOP
	↓	40
		<5
		170

8 **F**

10	←	55
380	→	20
610	↑	STOP
	↓	10
		625
		15
		335

9 **C**

690	←	140
	→	5
	↑	STOP
	↓	1010

10 **F**

425	←	200
270	→	40
	↑	STOP
	↓	170
		840

11 **E**

15	←	55
295	→	15
	↑	STOP
	↓	10
		950

12 **F**

70	←	750
240	→	135
	↑	STOP
	↓	15
		180

- (B)** Level of Service
- 100 PM Peak Hour Volumes
- ↔ Lane Configurations
- Intersections
- ⊕ Umatilla City Limits
- ⬡ Urban Growth Boundary

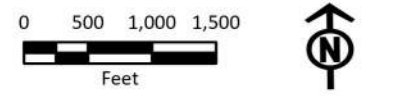

Table 4-2 Summary of 2043 PM Peak Hour Delay and Level of Service

Intersection	2043 PM Peak Hour					
	Overall Intersection			Worst Approach		
	Delay	LOS	V/C	Delay	LOS	V/C
1. Brownell/Third	*			NB-9.7	A	0.13
2. Powerline/US 730	*			NB-4717	F	>2.0
3. Switzler/US 730	*			SB-117.6	F	0.67
4. River Road/US 730	*			NB-1218	F	>2.0
5. Brownell/US 730	24.1	C	0.53	SB-38.0	D	0.68
6. SB I-82 ramps/US 730	26.7	C	0.71	SB-37.0	D	0.90
7. NB I-82 ramps/US 730	*			NBL>999, (EBL-160)	F	> 1.0 EBL 1.25
8. US 395/US 730	121.8	F	0.89	NB-142.6	F	1.38
9. Columbia/US 730	*			SB-23.1	C	0.48
10. Willamette/US 730	*			SB-7673	F	>2.0
11. Bud Draper/US 730	*			SB-36.8	E	0.44
12. Beach Access/US 730	*			SB-97.3	F	1.17
13. Powerline/Madison	*			EB-40.0	E	0.58

LEGEND

60.8/E – 0.05 Delay (seconds)/Level of Service and V/C ratio using existing lane configurations

* Uncontrolled Movements (major street through) not provided for overall intersection Analysis for Two-way Stop Controlled Intersections

NB = northbound, SB = southbound, WB = westbound, EB = eastbound

4.6 Future Roadway Network

As growth occurs and the City experiences new residential and industrial development, traffic volumes will increase, and mobility will be impeded. It will be necessary for new roads to be constructed to serve the additional demand and provide opportunities for traffic to move to desired destinations. While new roads are not necessarily prioritized in the Capital Improvement Program, new corridors should be preserved as development occurs. Additional access to the McNary area will be important as volumes on US 730 increase, making it more challenging for McNary residents to get into and out of the neighborhood. Additional access will reduce the impacts and delay at Willamette Street as described in Chapter 6. Figure 4-3 shows the future network for the City with new roads being added to serve where development is anticipated.

With the significant development anticipated on South Hill and the importance of Powerline Road to service traffic into and out of that area, the City is pursuing partnerships with developers and is working to create desirable cross-sections for Powerline Road. The City is working towards having a two-way left turn lane, sidewalks as well as a separated 10' pathway along the corridor. Phasing of this project is

being developed with initial phasing south of Radar Road to improve access to industrial development in the southern portion of the City.

Many of the future neighborhood connections will be constructed by development as it occurs. Others will require a combined effort supported by the city, for instance to coordinate a new canal crossing west of Powerline Road to provide additional access to South Hill will be important to provide secondary access to South Hill. The need for a future canal crossing is recognized by the West Extension Irrigation District. The City should evaluate potential feasible locations and coordinate the preservation of a corridor for the future.

The City of Umatilla also recognizes the need to make improvements to roads in the downtown area to serve as detour routes for traffic during local events as well as in times of emergencies or serious injury accidents that may close the road for an extended time. Routes that could be used for the purpose of detours include:

- 3rd Street north of US 730 – This route has the advantage of having a longer connection to the east of I-82. It has the disadvantage of needing to cross the railroad tracks, and it also ends just to the west of Switzler Avenue. The route could be reconstructed and extended further to the west to the Umatilla River in Old Town on the old alignment which has deteriorated to unusable status. If funding could be obtained this would be the ideal solution to serve the greatest need.
- 5th Street north of US 730 – This route is only usable from Switzler west to the Umatilla River. It could be extended a few blocks to the east, but would necessarily terminate due to the railroad tracks.
- 7th Street on the south of US 730 – This route is continuous from the Umatilla River on the west to the railroad tracks on the east. It has shortcomings however, in that it is a narrow road and passes in front of the middle school and high school.

Although not ideal, until funding is obtained to improve 3rd Street and extend it to the west, or if development were to occur, there is an interim alternative. It is possible to use Brownell Blvd to go north to 3rd Street, west on 3rd Street to Switzler Avenue, north on Switzler to 5th Street and west of 5th Street to A Street to have traffic avoid all of downtown.

It is also important to acknowledge the need for a new Umatilla River Crossing (not shown in Figure 4-3). The City of Umatilla joined a partnership with Umatilla County and the City of Hermiston to study potential crossing locations. The preferred location, as described in the Preliminary Engineers Report, is Punkin Center Road which intersects with Powerline Road just south of the Exit 5 interchange and provides an east-west connection to US 395. This will provide relief to US 395, US 730, River Road and the I-82 Exit 1 interchange as well by providing options for traffic in the area to use less traveled routes to avoid congestion.

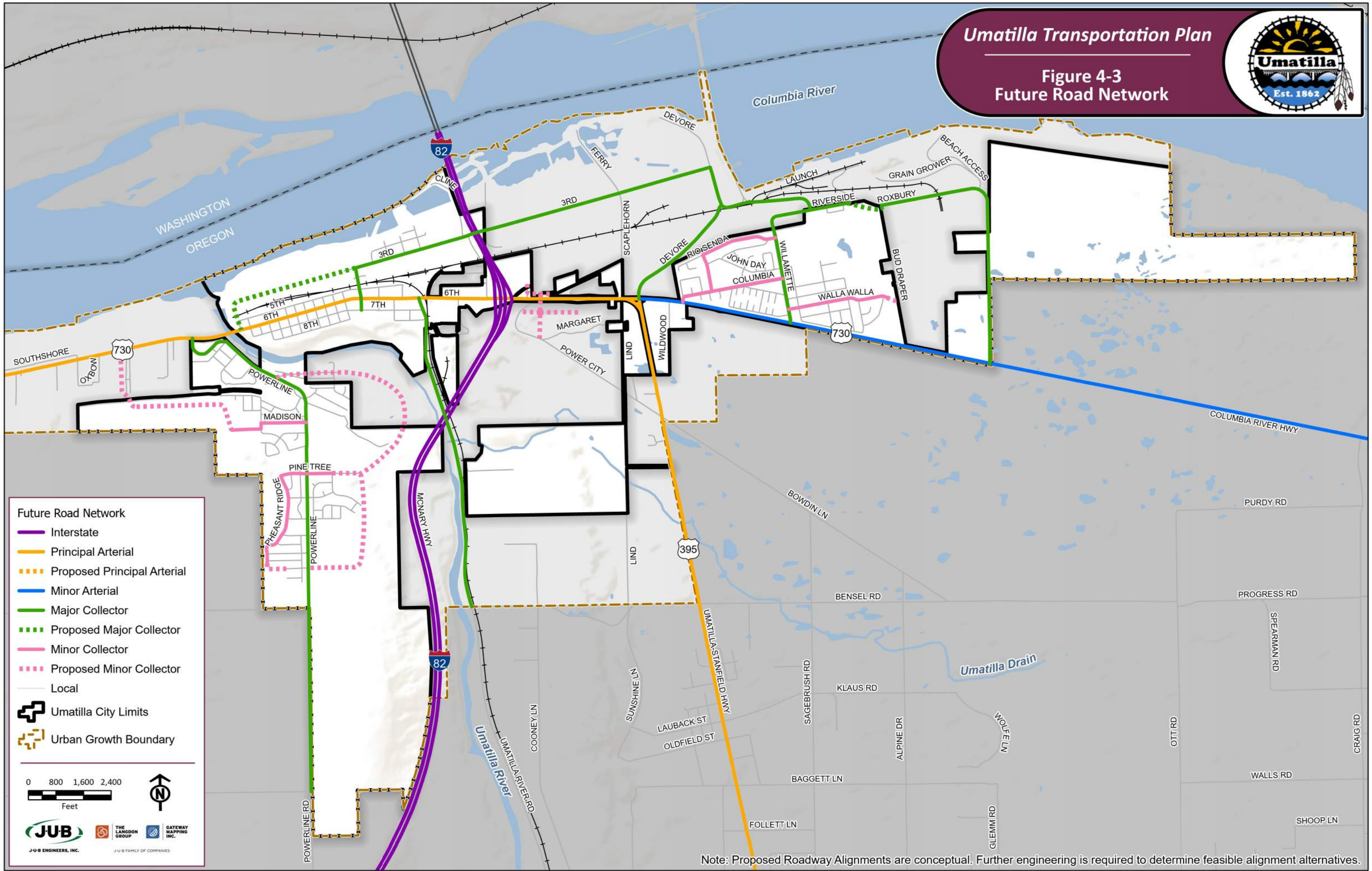

Future Road Network

- Interstate
- Principal Arterial
- Proposed Principal Arterial
- Minor Arterial
- Major Collector
- Proposed Major Collector
- Minor Collector
- Proposed Minor Collector
- Local
- Umatilla City Limits
- Urban Growth Boundary

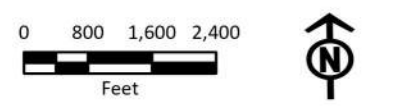

Note: Proposed Roadway Alignments are conceptual. Further engineering is required to determine feasible alignment alternatives.

Chapter 5 - Public Involvement

Public involvement is an intentional process used in master planning to provide information to the public and key experts, and to gather and incorporate feedback. This process ultimately helps identify opportunities and challenges and produce a plan that is well thought-out and supported by the community.

As part of the development of the TSP, The Langdon Group (TLG) (a subsidiary of JUB Engineers specializing in public education, facilitation, and community outreach) was contracted to provide professional public involvement services for the transportation system master planning project. TLG's approach is to provide early and continuous public education, reinforce project transparency, build public trust, and support two-way communication between key stakeholders. To best inform the project planning team, TLG used a variety of public involvement methods to gather a comprehensive community perspective. In coordination with the project team and City Staff, the following methods were used:

1. Stakeholder Interviews
2. Technical Advisory Committee
3. Public Open Houses
4. Interactive Online Public Comment Map

An overview of each of these components is provided below. See Appendix I for a comprehensive report on the process and findings for each.

Stakeholder Interviews – Key community members were consulted with the goal of collecting direct feedback from local experts on the challenges and opportunities of Umatilla roadways. In total, 8 interviews were conducted. Main themes of discussion centered around: Expected Local Growth, 730 Corridor and Intersections, Freight Traffic, Support for Roadways and Infrastructure, Safety, Priority Improvements, and Opportunities and Long-Term Projects.

Technical Advisory Committee – A team of key members were identified as a technical advisory committee to guide the planning team in the selection of a preferred alternative. Committee members represented: The City of Umatilla, Oregon Department of Transportation (ODOT), Umatilla County, the Umatilla School District, and the Umatilla Police Department. Two technical advisory committee meetings were hosted.

Public Open Houses – An in-person public open house was hosted in July of 2022, and a virtual public open house was hosted in January of 2023. Updated project information was presented at both of these open houses, as well as the opportunity to provide direct feedback.

Interactive Online Public Comment Map – A web-based public information site was developed and hosted on the City of Umatilla's website. The project site provided information and included an interactive comment map for the general public to leave geo-specific feedback on the current transportation system. Five categories of potential comments were provided, and 33+ comments were received for the first open house. There were also 26 comments received on the capital improvement projects included in the virtual open house in January. Comments from both open houses are included in Appendix I.

Chapter 6 - Alternatives Analysis

Chapter 4.5 discussed traffic operations with forecast traffic volumes with existing intersection geometries and traffic control and identified locations where Level of Service deficiencies are expected. This chapter discusses alternatives analysis to address the capacity deficiencies at study intersections. There are seven intersections identified in Chapter 4 as having future capacity needs. In the development of alternatives and recommendations for these intersections, consideration was given to the following factors:

- geometric changes such as new lanes to serve high volume traffic movements
- traffic control upgrades
- ability to address the capacity need
- physical impediments where applicable
- queueing where appropriate
- year of capacity failure and potential phasing

Capacity analysis worksheets for the alternatives evaluated for year 2043 that are discussed below are included in Appendix J. Costs for recommended improvements are included in Chapter 8. As these projects move to the design phase additional detail will need to be evaluated. The capacity analysis for existing and future conditions for this TSP focused on PM peak hour conditions because it is typically the worst case scenario. Prior to design, updated traffic counts should be collected for both the AM and PM peak hours and forecasts should be prepared to ensure that the selected improvement will accommodate both peaks.

It should be noted that the traffic forecasts discussed previously are based on a number of assumptions and the certainty of the forecasts, as always, is unsure. The best information available was used in preparing the forecast, but the economy will determine when and how much of the industrial development will occur, and available housing and housing preference will determine where new residents will live and whether they will choose to live in Umatilla, nearby Hermiston or other nearby communities. Intermediate year traffic forecasts were also prepared for year 2028, 2033 and 2038 using a straight-line interpolation between 2022 and 2043 to determine what year each intersection would need improvements if the forecast traffic volumes are realized. Additional information on intermediate year forecasts and level of Service Worksheets are included in Appendix K.

Powerline Road/US 730 (Intersection #2)

Powerline Road was previously realigned to intersect with US 730 further west of the Umatilla River in order to add capacity and safety improvements to service the increased traffic using Powerline Road to the south. Sight distance was improved as well as incorporating a westbound left turn lane to reduce vehicle conflicts. It is anticipated that traffic volumes will continue to grow.

By year 2028 the intersection will fall below acceptable LOS. Forecast volumes will eventually require an upgrade to traffic control at the intersection. Three alternatives were evaluated:

Short term improvements – US 730 has very wide shoulders as well as a wide center median that is not specifically striped to receive a northbound left turn from Powerline Road. If the west leg were restriped to include an eastbound right turn lane and to accommodate northbound left turns

into the center two-way left-turn lane (allowing for a two-stage left turn movement), along with an exclusive northbound left turn lane, acceptable LOS and V/C ratio could be provided until at least year 2028. This upgrade could help improve traffic operations until funding can secure, and design of a more permanent solution can be completed.



1. The City of Umatilla has had discussions with ODOT regarding this intersection and the need for additional capacity. Both entities have agreed that this intersection could be served well by a roundabout. A roundabout was evaluated, and it was determined that a single lane roundabout would serve forecast volumes until at least year 2038 based on the assumptions used in the forecasting process. If the volumes forecast for year 2043 are achieved a second approach lane for the eastbound approach to accommodate right turning vehicles will be needed.
2. A traffic signal was also evaluated at this location. In order for a traffic signal to provide acceptable LOS for the intersection two approach lanes for each of the three legs will be needed to serve each movement, namely: northbound left and right turns, eastbound through and right turns and westbound through and left turns. LOS "C" for the overall intersection would be achieved in year 2043 with V/C of 0.75. This intersection is not likely to meet traffic signal warrants for any condition identified in the Manual on Uniform Traffic Control Devices (MUTCD) except for the Peak hour warrant.

The recommendation for this intersection is to implement short-range striping improvements while funding and design of a single lane roundabout is completed. Design could consider positioning the roundabout such that an eastbound right turn could be added in the longer term future. The city owns substantial right-of way on the north side of the intersection to accommodate the construction of a roundabout.

Umatilla River Road/US 730 (Intersection #4)

The intersection of Umatilla River Road at US 730 has a westbound left turn lane as well as an eastbound right turn lane. The intersection currently experiences unacceptable delay during the PM peak hour and it is anticipated that traffic volumes will continue to grow. Forecast volumes will eventually require an upgrade to traffic control at the intersection.



Three alternatives were evaluated:

1. Short term improvements – similar to the Powerline Road intersection at US 730, Umatilla River Road also has a wide center median that is not specifically striped to receive a northbound left turn from Umatilla River Road. Elsewhere in the corridor the center lane is striped to function as a two-way left-turn lane. If the west leg were restriped to accommodate northbound left turns into the center two-way left-turn lane, acceptable LOS and V/C ratio could be provided until at least year 2028. By year 2033 separate lanes for the northbound left and right turn movements will be needed as well to provide acceptable LOS and V/C ratios. This improvement could help improve traffic operations until funding can be secured and design of a more permanent solution can be completed.
2. A roundabout was evaluated and it was determined that a single lane roundabout would serve forecast volumes until beyond year 2043 with average vehicle delay being 25.7 seconds for LOS “C”. There are challenges with a roundabout at this location because of the limited sight distance caused by the proximity to the railroad overpass to the east. This may be mitigated to some extent by the reduction of speeds as is typical for roundabouts.
3. A traffic signal was also evaluated at this location. A traffic signal added to the existing intersection geometry with a single northbound lane could be expected to provide acceptable LOS for the forecast 2043 traffic volumes with overall LOS “C” and V/C of 0.72. An additional corridor benefit of a traffic signal is that it would create gaps in the mainline flow of traffic that would benefit side street traffic to enter the flow. It would also provide a safe place for pedestrians to cross US 730.

The recommendation for this intersection is to implement short-range striping improvements, without adding a northbound right turn lane while funding and design of a traffic signal can be completed. The

traffic signal would be needed prior to year 2033. Since the project is limited to installation of traffic signal poles it appears that no right-of-way is needed.

I-82/Northbound ramps/US 730 (Intersection #7)

The northbound I-82 off ramp currently experiences unacceptable delay, with over 200 seconds of average vehicle delay and V/C ratio greater than 2.0 during the PM peak hour. At some point in the future the delay for the eastbound left turn will also rise to unacceptable levels as noted in Table 4-2. The intersection needs a higher level of traffic control such as a traffic signal or roundabout. Of extreme importance at this location is the proximity of the nearby traffic signals to the west at the I-82 southbound ramps and the intersection of Brownell Blvd which are so close together at 160' that they function as a single traffic signal. The distance between the I-82 northbound and southbound ramps is 400'. The current lane configuration east of Brownell Blvd is two through lanes in each direction with a center two-way left-turn lane (TWLTL). Between the ramps the TWLTL functions as back-to-back left turn lanes, meaning that the queues in each direction use the same space. Left turning traffic in the eastbound direction often backs up using most of the storage space which causes westbound left turning traffic to be stopped in the westbound through lanes. Another of the traffic operations challenges by users is that with the weigh station in close proximity to the west there is significant truck traffic using the interchange that can quickly use up storage space for stacking vehicles waiting their turn. The second westbound through lane also is reduced to one lane about 400' west of Brownell Blvd.



The proximity of the traffic signals to the west do not lend themselves particularly well to installing a roundabout at the northbound ramps. The following traffic signal alternatives were considered:

1. Install a traffic signal with no additional lanes. A new traffic signal has been recommended by other studies, including the 1999 TSP and the 2011 IAMP, but would still require ODOT approval. More detailed traffic data will need to be obtained to perform a traffic signal warrant analysis. It will be important to count the eastbound left turn volume separately and compare this volume to the westbound approach volume. A brief examination of those conflicting volumes shows that this conflicting volume is more likely to meet signal warrants before the northbound ramp volume since that volume is much lower. The existing eastbound right turn and westbound approach volumes appear to meet the peak hour warrant curves included in the Manual on Uniform Traffic

Control Devices, especially if considering the curves for communities of less than 10,000 population. The addition of a traffic signal will accomplish at least two things from a traffic operations perspective: 1) it will create or force gaps in traffic on US 730 in order to reduce delay for the northbound entering traffic, particularly the northbound left turn, and 2) it will better manage queue lengths between the northbound and southbound ramps. It will also improve safety for pedestrians and bicyclists using the interchange as well as for both the northbound left turns and the eastbound left turns that must currently cross two lanes of westbound traffic without the aid of a traffic signal. The addition of a traffic signal is anticipated to provide acceptable LOS and V/C until at least year 2033 without having queue storage issues between the ramps. It is anticipated that as the traffic volumes rise that combined eastbound and westbound left turn queues will exceed 400' by year 2038. Signal timing adjustments may shorten queues for a longer period of time, but the signals can work together to help manage stacking.

2. To better accommodate traffic volumes in 2038 and beyond additional lanes were considered along with the traffic signal. The high westbound right turn volume of 470 vehicles exceeds that of the through volume of 440. By year 2043 these volumes are forecast to grow to 660 through vehicles and 645 right turn vehicles. The need for a westbound right turn lane is clear. The provision of a right turn lane will improve traffic operations at the intersection to acceptable LOS and V/C, however combined eastbound and westbound queue lengths between the ramps are forecast to use the entire 400' available. There is a graphic in Appendix J that shows the lane configurations for this alternative.
3. Other lane configurations were also tested to determine if lanes could be used more efficiently to reduce queue lengths, and to also provide future options that could be considered when AM traffic volumes are evaluated at the design stage as well. Given the constraints between the ramps that are caused by the bridge structure it was felt best to not add lanes unless absolutely necessary. Given the high eastbound left turn volume conflicting with the westbound through movement a second eastbound left turn was added to reduce the amount of green time in the signal cycle needed by that movement. For this alternative one eastbound through lane would be converted to serve as a second eastbound left turn lane, this eastbound would require a second receiving lane for the northbound on-ramp. This would be in addition to constructing an exclusive westbound right turn lane at the northbound ramps, similar to Alternative 2. It was found that with this lane configuration although delay can be acceptable the V/C ratio for this intersection is high at 1.08. A single eastbound through lane would cause eastbound queues to spill back through the southbound ramps.
4. With nearly equal volumes of traffic westbound that turn right and going straight, the idea of constructing a new lane for right turns and using the existing five lanes across US 730 as only one lane for westbound, two eastbound left turns and two eastbound through lanes. Delay for this alternative is acceptable as well as V/C ratios, so this alternative serves better than Alternative 2 in accommodating the traffic volumes forecast for year 2043. The westbound queue at the southbound ramp is longer than the available storage length and thus some vehicles would necessarily have to wait through two signal cycles at the northbound ramps. One geometric feature that is worth noting in this area is that the westbound lanes narrow to a single lane to the west under existing conditions. There is a graphic in the Appendix J that shows the lane configurations at for this alternative as well.

The recommendation for the intersection of the I-82 northbound ramps at US 730 it to install a traffic signal with the addition of an exclusive westbound right turn lane. It is possible to phase this project to

add the westbound right turn lane at a later time since it appears that traffic volumes through year 2038 can be adequately served until that time. Additional right-of-way on the north side of US 730 de may be needed to accommodate the proposed westbound right turn lane.

US 395/US 730 (Intersection #8)

The intersection of US 730/US 395 currently experiences overall vehicle average delay of 53 seconds with LOS “D”. The worst movement being the westbound left turn is over 95 seconds of delay and uses all of the available storage space (220’) during the PM peak hour. ODOT has a project underway that is evaluating new signal timing for the signal to improve traffic operations as is the standard practice. It is anticipated that adjustments to signal timing may continue to provide acceptable LOS for the intersection to year 2028. However, beyond year 2028 it is anticipated that physical improvements to the intersection will be required.



The alternatives evaluated at this intersection to accommodate heavy westbound left turns, westbound through and northbound left turn movements include:

1. A minimal improvement option was tested that would convert one of the westbound through lanes to be a second westbound left turn lane, and add northbound right turn lane that could avoid relocation of the existing signal pole in that quadrant and allowed the existing two northbound lanes to serve have a dual left turns. Although this intersection configuration does reduce the overall delay and V/C and shortens the westbound left turn queue, it does not achieve acceptable traffic operations.
2. In order to achieve acceptable LOS and V/C at this intersection a second exclusive westbound left turn lane and a second northbound left turn lane will be required after year 2028. In order to accomplish this a second southbound receiving lane south of the intersection will need to be constructed that as well will need to be at least 350' in length and will also need to accommodate an acceptable merge for the eastbound right turn which currently has its own receiving lane as well. This will likely impact other improvements being considered by the City that may include a fountain feature on the island in the southwest quadrant. Storage length for the two new left turn lanes should be at least 400'.

The recommendation at the intersection of US 730/US 395 is to add a second northbound left turn lane, a second westbound left turn lane and a second southbound departure lane to receive the two westbound left turn lanes. The eastbound right turn lane should be modified at its connection to accommodate a safe merge area for southbound vehicles. This improvement will be needed in the 2028 – 2033 timeframe. There is likely to be right-of way acquisition on the south and east legs of the intersection to accommodate the additional turn lanes.

Willamette Street/US 730 (Intersection #10)

Willamette Street currently has a single approach lane to US 730. It has high delay but some available capacity during the PM peak hour at V/C ratio of 0.76. By year 2028 the V/C will reach 0.97 and need improvements. With a single access from US 730 into the McNary neighborhood and the increase in traffic volumes in both directions on US 730 it is anticipated that the eastbound left turn will also experience poor delay and V/C ratio.



Several alternatives have been evaluated and are described briefly below that include improvements at the intersection as well as new access to provide opportunities to shift traffic patterns to reduce delay without the need for a traffic signal.

1. Initially improvements to the southbound approach of Willamette Street to provide an exclusive southbound left turn lane. This will help conditions until between 2028 and 2033.
2. The intersection of Columbia Boulevard (Intersection #9) is currently outbound lanes only from the neighborhood. There has been some reservation to allow inbound traffic due to the lack of an exclusive eastbound left turn lane for traffic to wait for gaps in westbound traffic. This improvement alone could significantly reduce delay for the eastbound left turn traffic at Willamette Street by relocating up to half of the left turning vehicles. This will be a challenging improvement, due to physical constraints with existing development on the south side of US 730 and it will be likely that right of way will need to be acquired. This improvement would be best approached through coordination with improvements to the westbound US 730 improvements needed at US 395 described above.

3. Another access that can reduce delay, especially for southbound left turns is to provide new access by extending Walla Walla Avenue east of the current terminus to connect to Bud Draper Road. This approximately 400' connection would provide new opportunities to connect to the industrial development to the east. This improvement needs to be coordinated with other City improvements to Hash Park on the northwest corner of US 730 and Bud Draper Road.
4. An additional access opportunity for the McNary neighborhood is to connect Riverside Avenue north of the golf course to Roxbury Road or Bud Draper Road. The new length of road may be between 500 – 1000' due to some topographical challenges to bring Bud Draper Road, Roxbury Road and Riverside Avenue together while creating a safe intersection. This in turn would give access to Bud Draper Road as well as Beach Access Road.

The recommendation to improve traffic operations at the intersection of Willamette Street/US 730, rather than install a traffic signal, is to construct intersection improvements that would provide two lanes for the southbound approach, one for right turns and one for left turn movements. Secondly, at the time of improvements to the US 395 intersection to the west that are discussed above and recommended to occur between 2028 and 2033, improvements to the intersection of Columbia Boulevard should be made to safely accommodate eastbound left turns into the McNary neighborhood. The City should also pursue the extension of Walla Walla Avenue, a relatively short connection to the east. The Extension of Riverside Avenue to connect to either Bud Draper Road or Roxbury Road should also be investigated as it could provide a significant alternate route for the McNary neighborhood to access the anticipated industrial development to the east. The City owns sufficient right-of way on the north side for improvements at Willamette Street and Columbia Boulevard, and also owns the parcels needed to extend both Riverside Avenue and Walla Walla Avenue

Beach Access Road/US 730 (Intersection #12)

Beach Access Road currently functions with acceptable LOS. Without improvements, by year 2043 with the forecast traffic volumes it is anticipated that there will be nearly 2 minutes of average vehicle delay for the southbound right turn, even with the existing exclusive right turn lane. Between year 2033 and 2038 it is anticipated that improvements will be needed. Alternatives considered include:

1. Converting the westbound right turn lane to a westbound shared through and right turn lane by adding a departure lane that could be used by southbound right turns. This would improve the delay for a number of years. Extension of the southbound right turn storage would be needed as well.
2. Similar to Alternative 1, add a westbound departure lane that would not be used for westbound through vehicles, but would only be used for the southbound right turns, essentially making this movement a free-flow right turn. The southbound right turn storage would need to be increased as well. The length of the departure lane should be at least 1000' to allow vehicles to accelerate to highway speed and merge with the through traffic. There is a driveway 1000' to the west and improved safety would be to extend the acceleration lane further to the west. 2000' west is where the right turn lane at Bud Draper Road begins.
3. With the high peaking demand associated with the industrial development it may be possible for alternate work schedule departure times to be adjusted to spread out the traffic demand which would contribute to the solution for this intersection.

4. Other improvements discussed above for access to the McNary neighborhood could alleviate the demand for the southbound right turn by giving other travel route opportunities for westbound destined trips.

It should be noted that if these improvements do not completely solve the traffic operations issues, there is another meaningful opportunity to lengthen the additional westbound lane further west to connect to the existing section of US 730 that has four lanes, essentially extending the four lane section east to begin at Beach Access Road. The length of this project would be approximately 4300’.

The recommended improvement for the intersection of Beach Access Road is to increase the storage length for the southbound right turn to at least 400’ between 2033 and 2038, and monitor the traffic growth as the industrial development occurs to determine the need for additional westbound capacity on US 730 west of Beach Access Road. There is existing right of way on Beach Avenue to lengthen the right turn lane.

Powerline Road/Madison Road (Intersection #13)

At the Powerline Road/Madison Avenue intersection it is anticipated that traffic operations will function acceptably to beyond year 2038 with the current stop controlled condition and single lane approaches. As discussed earlier, the City is planning to add a center two-way left-turn lane on Powerline Road for safety and capacity. In addition to these improvements separate lanes for both the eastbound left and right turns as well as a southbound right turn lane will improve the capacity sufficient to allow eastbound vehicles to recognize gaps in the traffic flow such that acceptable Levels of Service will be provided at LOS “C”.

A roundabout or a traffic signal were briefly considered to serve the intersection, but given the cost of such improvements it is recommended that in the long term the eastbound left and right turn lanes and be incorporated with other improvements on Powerline Road when that road is improved. A southbound right turn lane should be considered as well if updated traffic forecasts indicate the need. The city owns the parcel on the northwest corner of Madison Road/Powerline road, thus no additional right-of way is needed.

Chapter 7 - Pavement Management

7.1 Current Pavement Management Practice

The City of Umatilla maintains all roads within the City limits with the exception of I-82, US 730 and US 395. There are approximately 48.5 miles of paved roadways. The City has not developed a formal Pavement Management Plan (PMP) but does perform pavement maintenance and management on an annual basis through visual assessments, conducting surface treatments, and capital improvements. The City's current maintenance and tasks include:

- Regularly cleaning out roadside borrow pits.
- Identifying roadways in need of maintenance through visual observations.
- Crack sealing and hot patch repair.
- Replacing pavement as a part of planned capital improvement projects.
- Collaborating with other jurisdictions to reduce costs.

Currently, there is no fixed budget amount for pavement maintenance, nor has there been a regular schedule for crack sealing and chip sealing of city streets. The City's goal is to begin budgeting on an annual basis for crack sealing and chip sealing. Budgeting approximately \$260,000 per year (not accounting for inflation) for pavement maintenance would allow for chip seal treatment of approximately two centerline miles of roadway, resulting in the City roadway network being treated once every 24 years. This approach will maintain the streets currently rated as fair or better (approximately 60% of the network) in good condition, consistent with the pavement management principles discussed in section 7.2. The City also intends to seek available funding to reconstruct deteriorated streets with poor or very poor pavement condition, since chip sealing is not a long-term solution. Reconstruction efforts of the poor and very poor streets are estimated to about \$19.3 million, not accounting for inflation. Where applicable, reconstruction efforts will be coordinated with other public works infrastructure needs such as water and sewer projects, which will increase potential grant funding opportunities and minimize unnecessary roadway cuts in the future. Other grant sources such as Safe Routes to School may also add sidewalks to streets currently without such facilities.

7.2 Pavement Management Principles

Those responsible for determining appropriate allocation of public funds to various programs and projects have a difficult job indeed. With limited funding they must determine the amount of funds to distribute to numerous worthwhile endeavors such as schools, law enforcement, human services, transportation and other public works activities, and other public functions that ensure the health and general welfare of the populace. Likewise, Public Works departments have similar challenges on a more focused agenda to balance budgets with needs.

Many different activities compete for the same funding sources. Knowledgeable professionals make the best decisions they can with available information. Sometimes emergencies arise created by natural events that require adjustments to previously planned programs for addressing public works needs and projects.

In order to make the best decisions possible for the maintenance and preservation of a roadway network, a Pavement Management System (PMS) can be extremely valuable. A PMS may be very complex with

sophisticated computer models, or may be done primarily by hand. Pavement and roadway condition data are essential to make the best use of available funds. A PMS empowers the governing agency with a systematic approach to performing budget analysis and deciding what repair strategies are most appropriate for which roadways in order to efficiently use available funds.

A PMS typically entails 5 steps that are repeated as necessary every two to three years:

- Mapping (GIS) Road Network
- Pavement Condition Inventory
- Identify Maintenance & Repair Needs
- Analyze repair strategies and establish annual funding levels
- Implement annual program.

A systematic procedure should be used each cycle to collect pavement condition inventory information. This provides an up-to-date inventory for better decision making and allows pavement performance to be tracked over time. Several different types of pavement distress can occur, each with different types of potential repair strategies. Often a computer program is used to determine the Remaining Service Life (RSL) for each roadway segment based on the governing distress (the distress that results in the lowest RSL). The RSL represents the years remaining until complete failure of the roadway surfacing. Complete failure occurs when a road segment has an RSL value of 0 and reconstruction of the road section (pavement, base, etc.) is required since the road segment has deteriorated to a point that other repair strategies would not be beneficial. The road is passable, but the surface is possibly turning to gravel, extreme fatigue is visible, sections of pavement may be detached or appear to be islands on the base material.

By evaluating the RSL distribution for the road network, allocation of funds to the appropriate repair strategies can begin. It is important that the repair strategy is focused on the goal of maintaining an average system RSL of 10-12 years which represents a level that can be reasonably sustained.

The goal of the analysis is to determine the best distribution of funds, among the available repair strategies, that should be completed each year to produce an average system RSL of 10 to 12 years at the least cost. Failure to maintain pavement at the necessary levels results in a decrease in the RSL and a correspondingly greater future cost to increase the average RSL to the desired level. Figure 7-1 emphasizes the importance of routine roadway maintenance activities prior to severe deterioration of pavement condition.

Repair strategies are chosen based on the condition of the road segment. Road surfaces RSL will dictate the repair strategy that should be used. Each repair strategy has multiple repair methods. The repair method used to implement a repair strategy should be based on the standard practices of the City/County. A new strategy is prepared for a two year period and updated to re-evaluate the pavement condition every two years thereafter. There are five generally accepted repair strategies explained below.

Deferred Action is always a viable option when developing a repair strategy. Most road networks will include a wide spectrum of RSLs for individual road segments. For the first few years after original construction, roadways should require very little maintenance. Likewise, when road segment RSLs becomes less than 3, routine and preventative maintenance will no longer improve the RSL. Reconstruction becomes the only alternative that will improve the RSL for road segments that have deteriorated to this stage. Reconstruction costs are very high and often not available in the maintenance

funds, therefore maintenance for certain roadways will be deferred until adequate funds are available to produce beneficial results that improve the road network system as a whole.

Figure 7-1 Typical Pavement Deterioration Curve

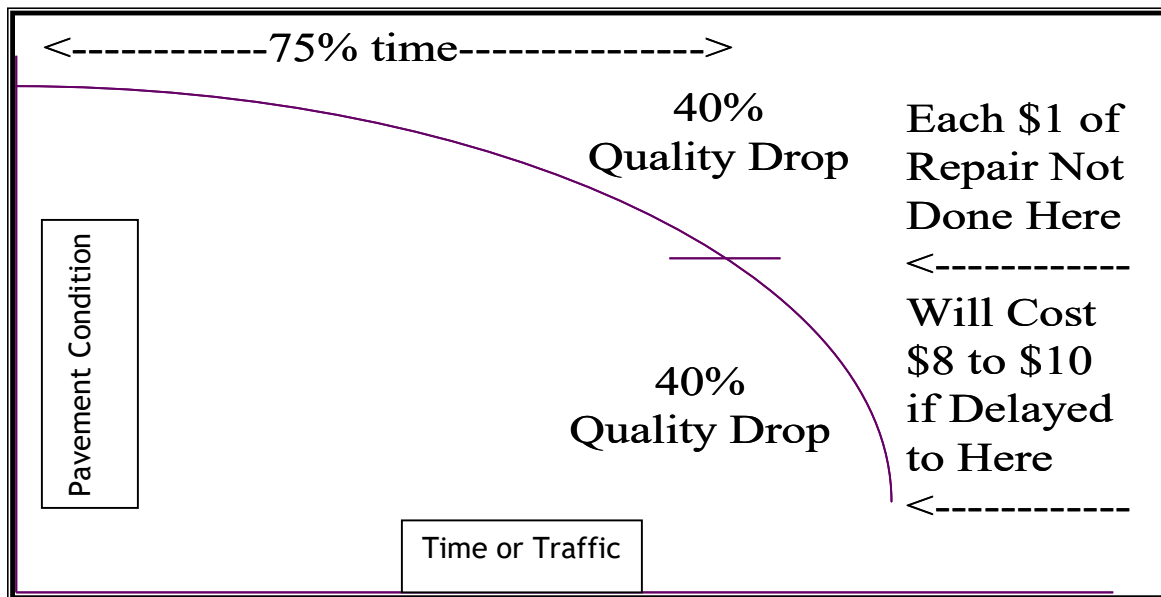

Routine Maintenance is usually driven by existing defects in the road surface. This maintenance can be used to prevent further deterioration of the roadway. Road segments that have RSLs greater than 7 to 10 years can benefit from routine maintenance. Examples of possible routine maintenance treatment alternatives include: crack sealing, cold patches, dig-out and cold patch, and fog coating.

Preventative maintenance is used to stop the deterioration on roadways before the surface distresses become a serious problem. This strategy provides the most benefit to a roadway if implemented before the RSL is below 7. Examples of possible preventative maintenance treatment alternatives include: sand seal, scrub seal, single chip seal, slurry seal, micro-surfacing.

Rehabilitation includes repair alternatives such as overlays and recycling. This strategy should be reserved for road surfaces that have a RSL between 1 to 7 years. The implementation of this strategy can require intense scheduling and will require allocation of a significant portion of the budget. This strategy should be reserved for road segments that fit into a major planning scheme. A possible candidate for such a strategy would be a road segment that is bordered by a newly constructed portion of that road and improving the segment would increase the overall performance of the road. Examples of possible rehabilitation strategy treatment alternatives include: plant mix seal, thin hot mix overlay (<2in., hot surface recycling, rotomill and overlay.

Reconstruction includes repair alternatives such as complete removal and replacement of a failed pavement section. Improving the road horizontal and vertical alignment, guard rail and drainage are all elements of a reconstruction strategy. This strategy will require considerable funding and lead time to

allow for proper design. Reconstruction of a road segment is going to increase the RSL to nearly 20 years. Therefore, this strategy is reserved for roads that are at the end of their design life. Examples of possible reconstruction strategy treatment alternatives include: Thick Overlay (3 inch depth), Rotomill & Thick Overlay, Base Repair with Pavement Replacement, Cold Recycling & Thick Overlay, or Base and Pavement Replacement.

Table 7-1 displays the benefit different treatment strategies provide in increased RSL over the existing roadway segment RSL along with a comparison of the order of magnitude for typical material costs for such treatments. For each treatment type, the treatment improves the RSL of a segment based on the segments current condition. As an example, crack sealing adds no additional life to a pavement that has a RSL of 9 or less. Above 9, crack sealing adds from 1 to 4 years, depending on the current pavement condition. Another example is chip sealing. Chip sealing is one of the most widely used preventative maintenance treatments. Chip sealing roads with RSL of 7 or greater increases the roadway RSL by 5 years. However, applying a chip seal to a road with a 4 to 6 RSL only adds 3 years, and applied to a road with a 1 to 3 RSL only adds 1 year. It can be seen that applying chip seals to roads with RSLs of 6 or less is not a cost effective approach.

Table 7-1 Typical Pavement Treatment Costs and Increased Remaining Service Life

Maintenance Type	Treatment Type	Comparative Cost to Crack Seal	Benefit of Treatment (in yrs.) Based on Existing RSL							
			0	1-3	4-6	7-9	10-12	13-15	16-18	19-20
Routine	Crack Seal	1	0	0	0	0	1	2	3	4
Preventative	Single Chip Seal	4	0	1	3	5	5	5	5	5
Rehabilitation	Thin Hot Mix Overlay (<2")	15	0	4	6	7	7	7	7	7
Reconstruction	Thick Overlay (3")	20	12	12	12	12	12	12	12	12
Total Reconstruction	Base & Pavement Replacement	50	20	20	20	20	20	20	20	20

Chapter 8 - Capital Improvement Plan

The Capital Improvement Plan (CIP) is comprised of projects identified in both Chapter 4 that discusses the future Roadway Network, as well as recommended projects from Chapter 6 Alternatives Analysis. These capital Improvement Projects would be in addition to regular pavement maintenance activities. Projects identified in the Trails Master Plan should be considered as well and incorporated into the overall CIP for the City. Table 8-1 summarizes the CIP projects that are shown in Figure 8-1. These projects have not been prioritized however, the year of need for projects was discussed in the Alternatives Analysis. Funding will need to be secured in order to proceed with design and right-of-way acquisition. Planning level cost estimates are included in Appendix L.

In addition to the projects developed as part of this TSP, projects for improvement of the overall transportation system that are included in the related plans discussed earlier, including the Trails Master Plan, Pedestrian and Bicycle Master Plan as well as the IAMP and upcoming Transit Plan are considered as part of this plan as well.



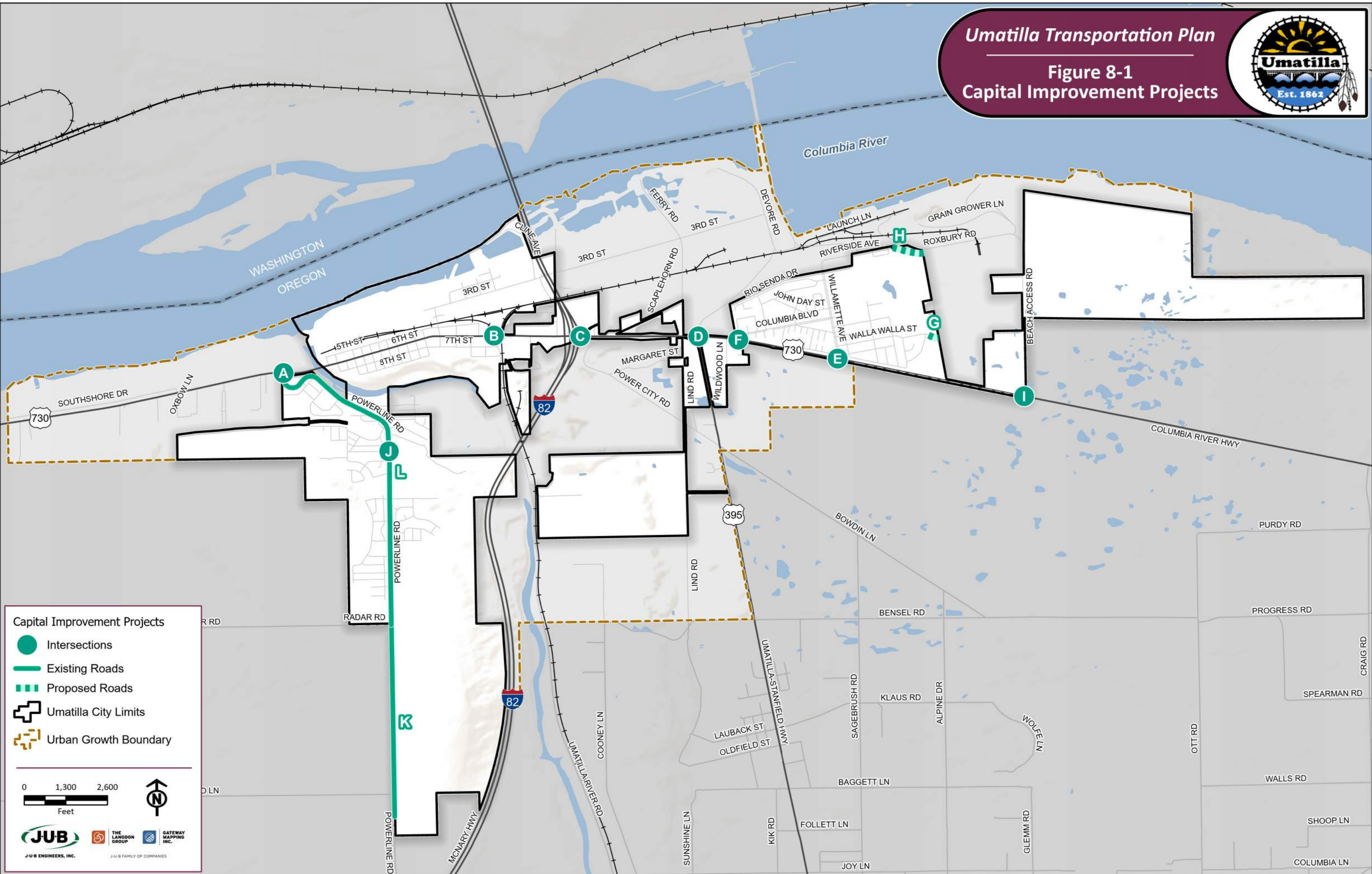

Table 8-1 Summary of Capital Improvement Projects

Project Location	Map Location	Description	Timeframe	Cost (\$ Millions)
Powerline/US 730	A	3. Use striping to create additional westbound departure lane	2023	*
		4. Install single lane roundabout	2028	\$1.403
River Road/US 730	B	3. Use striping to create additional westbound departure lane	2023	*
		4. Install traffic signal	2028- 2033	\$0.870
I-82 Northbound ramps/US 730	C	Install traffic signal, with exclusive westbound right turn lane	2023-2028	\$1.433
US 395/US 730	D	Add 2nd northbound left turn lane and 2nd westbound left turn lane with southbound receiving lane	2028-2033	\$4.007
Willamette/US 730	E	Add southbound left turn lane	2028-2033	\$0.107
Columbia/US 730	F	Add eastbound left turn lane and widen north leg to allow one inbound lane and a southbound right turn lane and left turn lane (make full access)	2028-2033	\$0.648
Walla Walla Road Extension	G	Construct Walla Walla Road eastward to connect to Bud Draper Road	2028-2033	\$0.407
Riverside Avenue Extension	H	Construct Riverside Avenue Extension eastward to connect to Roxbury Drive or Bud Draper Road	2028-2033	\$0.964
Beach Access/US 730	I	Extend Storage for southbound right turn lane.	2038-2043	\$0.163
Powerline/Madison	J	Add eastbound left turn lane and southbound right turn lane.	2038-2043	\$0.128
Powerline Widening - Phase 1	K	Widen Powerline Road south of Radar Road 1.07 miles to include two-way left-turn lane and 10' bike path	2023 - 2028	\$4.685
Powerline Widening - Phase 2	L	Widen Powerline Road south US 730 to include two-way left-turn lane and sidewalks on both sides	2023 - 2028	\$8.626

* These short term projects are minimal in cost and could be incorporated with ODOT or City maintenance efforts (with ODOT approval).



Capital Improvement Projects

-  Intersections
-  Existing Roads
-  Proposed Roads
-  Umatilla City Limits
-  Urban Growth Boundary

0 1,300 2,600
 Feet



JUB THE LANGDON GROUP GATEWAY MAPPING INC.
 J-U-B ENGINEERS, INC. J-U-B FAMILY OF COMPANIES

Chapter 9 - Implementation Plan

9.1 Implementation Overview

In order to successfully implement projects identified in this Transportation System Plan, available funding opportunities should be monitored on an annual, bi-annual, or quarterly basis. During the annual budgeting process, the City should update the overall CIP and determine which projects will be implemented in the budget cycle and include details such as potential funding sources, match requirements, etc.

The City should update relevant/pertinent sections of this overall plan every five years, or as projects are completed or priorities change. This will keep information up-to-date and help the City qualify for grant funding (by having an up-to-date plan versus an out-of-date plan), and provide guidance as development is proposed.

9.2 Grants and Funding

Transportation funding programs are enabled through the passage of the Fixing America's Surface Transportation (FAST) Act. For purposes of providing baseline information about potential grants and funding programs, a brief description of funding sources available through the current transportation bill is provided below.

- **Local Highway Safety Improvement Program (LHSIP)** — Local jurisdictions can receive funding through Highway Safety Improvement Program and LHSIP to assist in phasing out Type A crashes from roadway systems; Local Highway Jurisdiction's with at least one Type A crash in the last five years are eligible. Notification of qualification occurs each fall to begin application process. The application requires a local match not to exceed 7.34 percent.
- **Federal-Aid (STP Urban)** — Surface Transportation Program (STP) Urban funds are allocated for projects in urban areas with populations greater than 5,000 and less than 50,000 as determined by the US Census Bureau. Current urban areas are based on the 2020 census. Funds may be used for a new or updated Transportation Plan encompassing the entire urban area. The local match requirement is 7.34 percent.
- **Bridge Federal-Aid** — This program provides funding for rehabilitation or replacement of bridges and limits one project application per year per jurisdiction. The bridge must be longer than 20 feet and carry a public road, have a sufficiency rating of less than 50 percent for replacement and less than 75% for rehabilitation, and be classified as structurally deficient. Funds are administered by ODOT and requires a 7.34 percent match.
- **Transportation Alternatives Program (TAP)** — A maximum of \$500,000 is available and these funds are eligible for projects including pedestrian and bicycle facilities, community improvements, recreational trails, etc. These set aside funds are administered every year.
- **US DOT Rebuilding American Infrastructure with Sustainability and Equity (RAISE)** — The Rebuilding American Infrastructure with Sustainability and Equity (RAISE) Transportation Discretionary Grant program, provides a unique opportunity for the DOT to invest in communities across the country that are in need of transportation projects that create jobs, improve safety, protect the environment, and generate equitable economic opportunities for all Americans.

Previously known as Better Utilizing Investments to Leverage Development (BUILD) and Transportation Investment Generating Economic Recovery, or TIGER Discretionary Grants, Congress has dedicated nearly \$7.9 billion for eleven rounds of National Infrastructure Investments to fund projects that have a significant local or regional impact. For rural areas, there is typically a minimum grant amount of \$1 million for construction projects and no minimum match requirement. In order to be competitive, a minimum match of 20 percent is recommended. The Notice of Funding Availability (NOFA) typically comes out in February each year with application due date in late-April.

- **Safe Routes to School** - refers to efforts that improve, educate, or encourage children safely walking (by foot or mobility device) or biking to school. ODOT has two main types of Safe Routes to School programs: infrastructure and non-infrastructure. Infrastructure programs focus on making sure safe walking and biking routes exist through investments in crossings, sidewalks and bike lanes, flashing beacons, and the like. Non-infrastructure programs focus on education and outreach to assure awareness and safe use of walking and biking routes. ODOT manages funding competitions for both infrastructure and non-infrastructure programs at the annual levels of \$10 million (increasing to \$15 million in 2023) and \$300,000 respectively.

9.3 Implementation Strategies

The following strategies will help in the implementation of improvements to the transportation network.

- **Attend Funding Workshops** - Attendance at ODOT grant and funding workshops and federal funding webinars will be important. Funding workshops are typically held annually or periodically to educate eligible applicants on upcoming funding opportunities, scoring criteria, and program changes. This will help the City establish and maintain a solid knowledge base on the availability and status of various state and federal grant and funding programs.
- **Consider all Modes and other Capital Projects** - Opportunities to incorporate all transportation modes into each project will enhance safety of the transportation system. Opportunities to perform traffic calming and improve connectivity for all modes will be integral in assisting the community to meet the goals and policies of the Transportation System Plan. In particular, improvement projects aimed at maximizing travel choices should include design of intersection approaches, transitions and crossing treatments that comfortably let people of all ages and abilities to safely walk or bicycle. Construction projects should consider other Capital Improvements such as water and sewer in order to combine improvement projects and minimize roadway cuts for utilities.
- **Contact Funding Agencies Early and Often, Well Before the Deadline** - It is good practice to inform funding agencies of a potential upcoming project well in advance of a grant application deadline. If an agency desires to submit a grant application that is due in the fall or winter, it is recommended that City staff contact funding agencies as early as the beginning of the year. Grant agency staff can offer invaluable advice on how to put a successful application together as well as specific ideas about a project.
- **Project Development / Neighboring Agency Coordination** - For projects the City wants to implement in the near future, it is recommended to identify next steps. A typical next step toward implementation would involve taking a project from the planning phase to the project development phase. Depending on the type and location of the project, project development may involve site investigation, survey, environmental evaluation or a specific study, etc. For projects that abut

neighboring jurisdictions, the City should work closely with the affected agency to determine the next step to move the project forward.

- **Project Follow-Up** - Stakeholders provided significant input into this Plan. It is important to maintain ongoing communication with one another, as well as with the public as the Plan is implemented. Demonstrating projects that were completed is important for continued and future support of the Plan and its objectives. Forms of communicating with the public may include press releases, newsletters, social media, web links, etc.

UMATILLA TRANSPORTATION SYSTEMS PLAN

APPENDICES

Appendix A

Summary of Related Plans

- 2000 – US 395 North Corridor Plan
- 2002 -- Downtown Revitalization and Circulation Plan
- 2003 – City of Umatilla Pedestrian and Bicycle Master Plan
[Umatilla Ped-Bike Plan \(oregon.gov\)](#).
- 2007 -- US 730 Corridor Refinement Plan
[US730 Corridor Refinement Plan \(umatilla-city.org\)](#)
- 2011 – I-82/US 730 Interchange Area Management Plan
[I-82-US730 IAMP\(umatilla-city.org\)](#)
- 2020 -- Master Trails Plan
[master_trails_plan_2.4.20_approved.pdf \(umatilla-city.org\)](#)
- 2021 -- Umatilla River Trail
[Umatilla River Trail Concept Plan Final.pdf \(umatillacounty.gov\)](#)
- 2022 – Umatilla River Bridge Preliminary Engineering Report

Excerpts

US 395 NORTH CORRIDOR PLAN

VOLUME 1 CORRIDOR PLAN

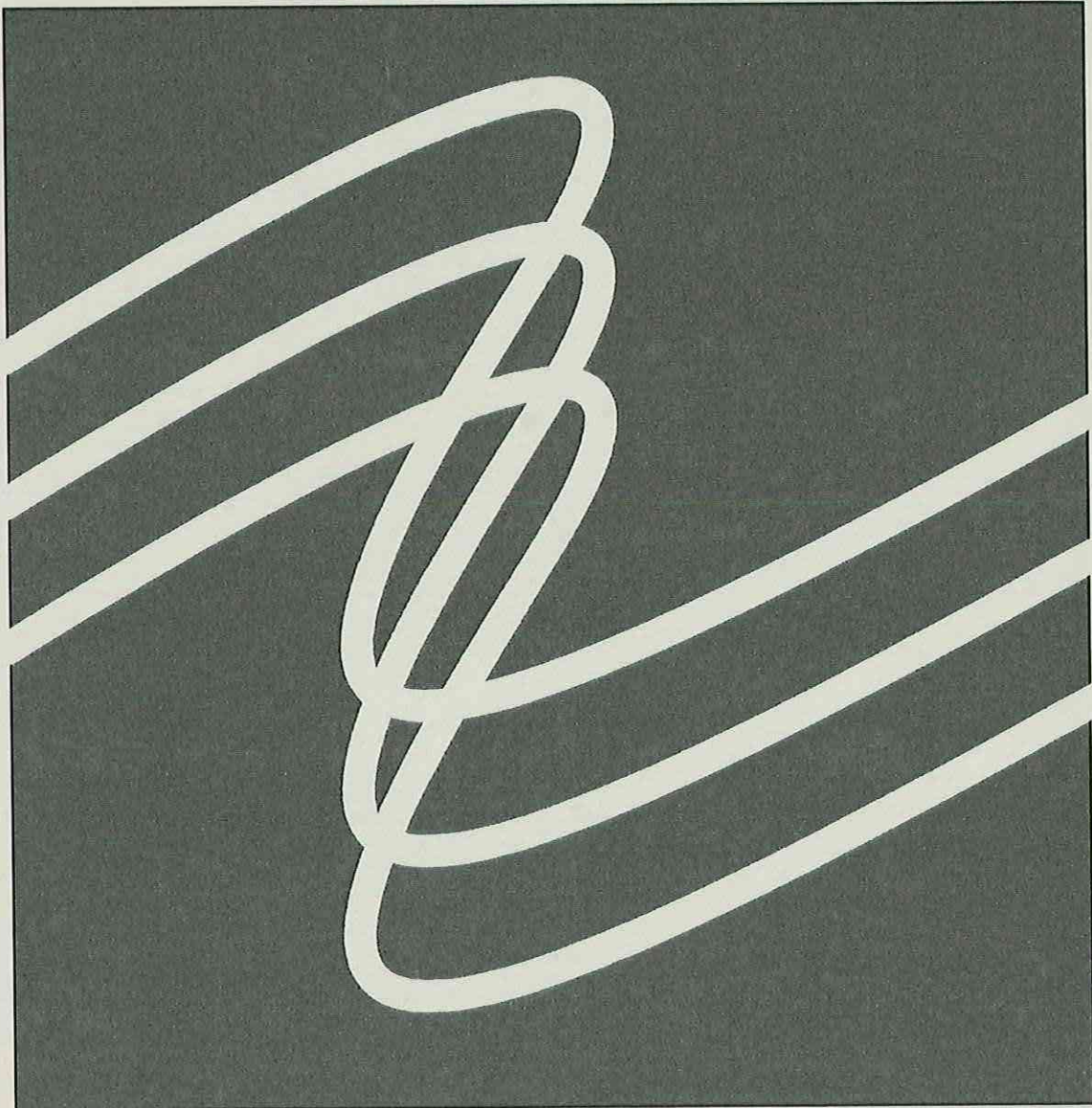

An Element of the Oregon Transportation Plan

Oregon Department of Transportation
Region 5

Adopted by the Oregon Transportation Commission
July 2000

TABLE OF CONTENTS

	<u>Page</u>
VOLUME 1	
I. INTRODUCTION	
A. Purpose and Scope	I.1
B. Corridor Planning Concept	I.2
C. Overview of the Corridor Planning Process	I.3
D. Revisions and Amendment Process	I.4
II. CORRIDOR OVERVIEW	
A. Corridor Description	II.1
B. Corridor Role	II.1
C. Existing Conditions	II.4
D. Key Management Themes	II.15
E. Financial Constraints	II.17
III. CORRIDOR MANAGEMENT	
A. Overall Management Direction	III.1
B. Corridor Plan Objectives	III.3
IV. CORRIDOR MAPPING AND DECISION DETAILS	
A. Description of Process	IV.1
B. Matrix of Strategies and Objectives	IV.2
C. Project List by Funding Priority	IV.3
D. Decision Mapping	
FIGURES	
1. Corridor Planning Process	I.5
MAPS	
1. Map of North/South Routes in Western United States	II.3
2. Rural General Zoning Classifications	II.9
3. Existing Conditions	II.13
4. Locations of Solutions	IV.D
5. Locations of off System Solutions	IV.D
TABLES	
1. 1999 Population and Employment Estimates	II.5
2. Population and Employment Projections	II.6
3. Summary of Highway Characteristics	II.11
4. Statewide Annual Funding Allocation	II.18
5. Corridor Funding Allocation	II.18
6. Projected Modernization funding Forecast	II.18
7. Relationship of Funding Categories	II.20

EXECUTIVE SUMMARY

A. CORRIDOR PLAN PURPOSE AND SCOPE

The US 395 North Corridor Plan is the product of a cooperative effort between the Oregon Department of Transportation (ODOT), local governments, interest groups, statewide agency and stakeholder committees, and the general public to develop a long-term program for management of and improvements to the US 395 North Corridor.

US 395 North is located in Umatilla County and stretches 12.9 miles from its junction with US 730 in the city of Umatilla through the cities of Hermiston and Stanfield, to the US 395/Interstate 84 interchange south of Stanfield. The corridor continues across Interstate 84 (1.6 miles) through the City of Echo's urban growth area. South of the I-84 interchange, the corridor follows Thielson Road, a two-lane county facility.

US 395 provides an alternative connection between two major freeways: Interstate 84 connecting Portland with Pendleton and Boise, Idaho, and Interstate 82 which runs north to the Tri Cities area of Washington, where traffic splits off for Seattle or Spokane.

Other transportation facilities and services within the corridor include: two Union Pacific (UP) railroad main lines and a branch line; the UP Hinkle Rail Yard; Greyhound Bus Lines, which provides intercity bus service between Hermiston and Portland, Boise, and Spokane; limited local paratransit services; the Port of Umatilla on the Columbia River; and a general aviation airport south of Hermiston. Commercial airports in Pendleton and Pasco also serve the corridor and Amtrak's *Empire Builder* provides daily service between Portland and Spokane via Pasco, Washington.

The purpose of the Corridor Plan is to establish both short and long-term management direction for all modes of transportation in the corridor and to make major transportation tradeoff decisions. This Corridor Plan identifies a variety of management objectives and improvements to transportation facilities and services within the corridor. Management objectives address the corridor as a whole, as well as specific sites and transportation improvements. The Corridor Plan also identifies priorities and timing for the various actions and responsible public agencies and other service providers.

Prioritized improvements to corridor facilities, systems and management identified in the Corridor Plan provide the basis for updating the State Transportation Improvement Program (STIP), which, in turn, is the basis for distributing the State's limited transportation resources. Corridor planning is helping ODOT, with the cooperation of local governments and input from the citizens of Oregon, make difficult funding decisions necessary to build and maintain a statewide transportation system that meets the growing demand for transportation over the next 20 years. Inclusion of any improvements in the Corridor Plan does not represent a funding commitment by ODOT or any local government, however, until programmed in the STIP and/or a local capital improvement program (CIP).

The US 395 North Corridor Plan builds on the strategies and policies found in the Oregon Transportation Plan (OTP), the Oregon Highway Plan (OHP) and other modal plans. It has also been closely coordinated with the development of local transportation system plans (TSPs), for the cities of Umatilla, Hermiston, Stanfield, and Echo, as well as Umatilla County. Through local transportation system planning and refinement planning for the Corridor Plan, periodic review

and local plan amendments, ODOT and the local governments in the corridor will cooperatively work together to ensure that city and county comprehensive plans and zoning ordinances achieve Corridor Plan management objectives. The Oregon Transportation Commission will adopt the Corridor Plan as an element of the OTP.

B. CORRIDOR PLANNING PROCESS

This Corridor Plan has been developed with active involvement of local governments and interest groups, statewide agency and stakeholder committees and the general public within the corridor. A Corridor Management Team (CMT) and Transportation Advisory Committee assisted in the authoring of this plan.

Key steps in the development of the Corridor Plan include:

- Identification of community and stakeholder issues, concerns and ideas about transportation modes in the corridor.
- Research and analysis of current conditions and future opportunities and constraints.
- Agreement on an overall corridor management strategy and objectives for the US 395 North corridor.
- Identification of key decisions that will implement the corridor strategy and objectives.
- Incorporation of all these pieces in a draft Corridor Plan.
- Following public and agency review, endorsement of the Corridor Plan by local governments and adoption by the Oregon Transportation Commission.
- As needed, refinement planning to address special issues. These refinement plans will then be folded into the Corridor Plan.

Implementation of the US 395 North Corridor Plan will occur over many years. During that time, it will be necessary to update and revise the Plan to reflect changing conditions and policy direction, to remain consistent with local TSPs or to better achieve Plan objectives. Refinement planning will also occur to address outstanding environmental, land use or other issues. Agency and public input will be solicited during refinement planning and Corridor Plan updates.

C. KEY FINDINGS

A number of key findings and conclusions were identified through the Corridor Plan process. These findings include:

- Public transit generally provides convenient connections and service frequencies to meet current user demand. Coordination of local service providers would lead to overall system efficiencies.
- US 395 is generally not suitable for bicycle travel due to high traffic volumes and four-foot shoulders throughout the corridor.
- Sidewalks on both sides of US 395 are concentrated in urbanized portions of Hermiston and Stanfield. US 395 is a barrier to safe pedestrian crossings.
- An estimated two thirds of truck traffic on US 395 North is pass-through, non-local traffic.
- Proximity of the corridor to a major freight rail hub is expected to attract development served by rail freight. There is adequate rail capacity to increase the frequency of trains that travel north through the corridor to the Port of Umatilla.
- Investment in management techniques, such as driveway consolidation, traffic signalization, and parallel route improvements, for US 395 have a more beneficial impact on congestion, travel time and safety than geometric or capacity improvements.

- Projected population and traffic growth in the corridor will result in unacceptable capacity deficiencies involving intersections along US 395.
- Accident rates on US 395 are 22% higher than the statewide average. The majority of accidents are intersection turning-related.
- Extensive vacant land that is zoned for commercial and industrial development exists along the corridor.
- Robust job growth is occurring in the corridor, which is stabilizing the existing agricultural-based economy.
- Most environmentally sensitive areas along US 395 are the extreme ends of the corridor in least developed areas. Archeological resources may be present in the corridor.

D. KEY MANAGEMENT THEMES

After analysis and review of the numerous policies, issues, opportunities and constraints that pertain to transportation in the US 395 North Corridor, the corridor management team and the technical advisory committee identified three key themes for the corridor plan. These key themes serve as a guide to plan development and provide direction for management of the corridor.

Enhance Travel Safety

The management direction for the corridor is to reduce the accident rate and severity of accidents to the statewide average. The recommended incremental approach to achieve the safety management direction varies for each corridor segment.

Manage Access

In general, access spacing for US 395 North will be managed based on the Statewide Highway classification as identified in the 1999 Oregon Highway Plan. The management objective of the Statewide Highway classification is to provide safe and efficient, high-speed continuous flow operation. In constrained and urban areas, interruptions to flow should be minimal. Inside Special Transportation Areas (STAs) local access may also be given priority. To assist in implementing state access management standards and policies, highway segment designations, such as STAs, are identified in the corridor.

Promote Alternative Modes

The overall management direction for bicycle and pedestrian activity in the urban areas of the corridor is to implement actions identified in local transportation system plans with emphasis on safe pedestrian crossings and development of multi-use paths and other pedestrian and bicycle links between community centers.

The overall management direction for public transportation and within the corridor is to maintain, expand and enhance transit service in the Corridor through coordination of transit providers. In general, transportation demand within the corridor will be managed through establishment of employee-based rideshare programs.

E. PROJECT PRIORITIES AND FUNDING

Limited revenues necessitate managing and improving the existing transportation services and facilities within the Corridor to accommodate the anticipated growth in travel. Accordingly, the Corridor Plan allocates state resources to highway projects according to the following priorities:

- (1) Maintenance of the existing facility to ensure that it remains safe and functional, e.g. fixing potholes;
- (2) Preservation of the roadway by investing in roadbed and pavement reconstruction as needed to minimize maintenance costs;
- (3) Transportation system management to optimize existing highway capacity;
- (4) Safety improvements; and
- (5) Projects that support economic development.

The projected total costs for the needs identified during the Corridor Plan process are over \$60 million. The highest priority projects were placed in the *Committed* and *Constrained* funding categories, meaning the projects should be implemented over the 20-year planning period. Committed projects are already funded in the current Statewide Transportation Improvement Program (STIP). Constrained modernization projects, totaling \$ 3.7 million, would be implemented in later years of the STIP and are still subject to funding authorization.

The projects next in priority were listed in the *Strategic* funding category that would be expected to be funded if current funding levels are increased due to new sources of funding during the planning period. *Strategic* funding modernization projects total \$6.9 million in costs including \$1.2 million in off-system, local street network improvements. Since such increased funding options have yet to be identified, it is assumed that *Strategic* projects could only be implemented in the intermediate-to-long-term, i.e., it would take at least 5 years for funds to be identified and project development completed.

All remaining projects were placed in the *Unconstrained* list. Based upon current revenue forecasts (including all reasonable additional sources of revenue), these projects are NOT likely to be funded within the 20-year planning horizon. However, *Unconstrained* projects could be funded by alternative funding sources, such as development exaction, local improvement districts, urban renewal districts, etc. Unconstrained modernization projects total \$31.3 million including \$22.7 million in off-system local street network improvements. The term "*Unconstrained*" means that if ODOT had all the funding to meet all Corridor needs that all projects could be funded. *Unconstrained* projects that are summarized in the project matrices are those that originated through the CMT or local TSP and have a demonstrated need. The relationship of these funding categories is shown in Table 1 below.

<i>US 395 North</i>	<i>Committed</i> (\$1000)	<i>Constrained</i> (\$1000)	<i>Strategic</i> (\$1000)	<i>Unconstrained</i> (\$1000)
All Projects	\$6,249	\$4,770	\$8,460	\$41,487
Modernization	\$1,936	\$3,740	\$6,903	\$32,275
Local Network	\$832	\$0	\$1,155	\$22,734

FUNDING PRIORITY: Constrained															
Proj	BEG. MP	END MP	HWY	REG	WORKTYPE	CITY	COUNTY	ESTIMATED COST	DESCRIPTION	JUSTIFICATION	FUNDING CATEGORY	LEAD AGENCY	Priority	SUPPORTING DOCUMENTATION	
39	5.5	5.8	333	5	Modernization	Hermiston	Umatilla	\$3,500,000	Diagonal Road/Elm Avenue (OR 207). Realign the six-way intersection.	Improve safety and operations	Constrained	ODOT	Mid-term	Region 5 SNASP List Hermiston TSP Improvement # 9	
63			333	5	Modernization	Hermiston	Umatilla	\$240,000	Improve 11th Street (OR 207) and Hermiston Avenue including signalization and rechannelization.	Improve operations	Constrained	ODOT	Near -term	Hermiston TSP Improvement #1	
53	184.11	184.11	2	5	Operations	Umatilla	Umatilla	\$350,000	I-82 Interchange/Point of Entry Improvements. Modify internal circulation and relocate the Brownell/US 730 intersection signal to the Eiselle Drive/Weigh Station entrance intersection.	Improve safety and traffic flow	Constrained	ODOT		Umatilla TSP	
55			2	5	Operations	Umatilla	Umatilla	\$150,000	Signalize the I-82 Northbound Ramp terminus/US 730 intersection	Improve safety and traffic flow.	Constrained	ODOT Umatilla	Near -term	Umatilla TSP # 1	
14	12	12	54	5	Safety	Stanfield	Umatilla	\$250,000	Construct a new street access and traffic signal on US 395 N, north of the I-84 interchange, approximately 1320 feet from the westbound on/off ramp of the I-84 interchange. Includes a left turn storage bay and right turn deceleration lanes.	Improve safety, LOS and accessibility	Constrained	ODOT		Stanfield TSP Option #9	
77	4.33	6.58	54	5	Pedestrian	Hermiston	Umatilla	\$25,000	US 395 (Theater Lane to SE Port Drive) Sidewalk repair, curb ramps, driveway management and refuge islands .	Improve safety and pedestrian movement	Constrained	Hermiston ODOT	Near-term	Hermiston TSP	
2	11.27	12.68	54	5	Bicycle Pedestrian	Stanfield Echo	Umatilla	\$255,024	Extend the multi-use asphalt path along the west side of US 395 North from Ball Avenue to the I-84 interchange. Also construct a 10' wide path along the east side of the US 395 from the north end of the I-84 overpass to approximately 1/4 mile north of the interchange.	Improve safety	Constrained	Stanfield		Stanfield TSP and Umatilla County TSP	
								Total Constrained=	\$4,770,024						
								Total Modernization=	\$3,740,000						
								Local Network=	\$0						

FUNDING PRIORITY: Unconstrained														
Proj	BEG. MP	END MP	HWY	REG	WORKTYPE	CITY	COUNTY	ESTIMATED COST	DESCRIPTION	JUSTIFICATION	FUNDING CATEGORY	LEAD AGENCY	PRIORITY	SUPPORTING DOCUMENTATION
11	7.38	7.38	54	5	Modernization		Umatilla	\$445,200	Traffic signals and geometric improvements at the intersections of US 395 North with E. Airport Road including curb returns, sidewalks and repaving approaches.	Improve operations and safety	Unconstrained	Umatilla County ODOT		Umatilla Co. Project # 32
13	N/A	N/A	Local	5	Modernization	Stanfield	Umatilla	\$2,618,400	Road improvements from downtown Stanfield past the sewage treatment plant and out to the rail yards. Widen the right of way in the rail yards from 12' to 40' to include 28' of pavement plus two 6' wide shoulders.	Improve accessibility and operations	Unconstrained	Stanfield		Stanfield TSP Project # 9
16	N/A	N/A	Local	5	Modernization	Umatilla	Umatilla	\$1,200,000	Powerline Road (County Road 1225) improvements. Widening and repaving for 2.5 miles south of I-82.	Improve safety and operations	Unconstrained	Umatilla County		Umatilla County TSP # 29
17	N/A	N/A	Local	5	Modernization	Umatilla	Umatilla	\$1,728,000	Powerline Road improvements from US 730 to I-82. Widen to include 6-foot wide shoulders and repave.	Improve safety and operations	Unconstrained	Umatilla County		Umatilla County TSP and HUES Report 1998 #3
21	N/A	N/A	Local	5	Modernization	Umatilla Hermiston	Umatilla	\$3,512,000	Umatilla River Road, from US 730 to Elm Avenue. Phase I improvements. Widen, align, shoulder and pave rural section/urban upgrade.	Improve safety and operations	Unconstrained	Umatilla (City) Umatilla County	Long -term	HUES Transportation Report 1998 Hermiston TSP #21 Umatilla Co TSP # 9
23	N/A	N/A	Local	5	Modernization		Umatilla	\$250,000	Intersection of Westland Road with Lamb and Walker. Align and reconstruct intersection on Westland Road.	Improve safety and operations	Unconstrained	Umatilla County		Umatilla County TSP/HUES Report 1998 Project # 8
24	N/A	N/A	Local	5	Modernization		Umatilla	\$450,000	N. Ott Road from Punkin Center Road to Bensel Road. Reconstruct and pave.	Improve safety and operations	Unconstrained	Umatilla County		Umatilla County TSP Project # 25
25	N/A	N/A	Local	5	Modernization	Hermiston	Umatilla	\$1,386,000	S. Ott Road from Highway 207 to E. Loop Road. City acquisition/urban upgrade.	Improve safety and operations	Unconstrained	Umatilla County		Umatilla County TSP Project # 20
26	N/A	N/A	Local	5	Modernization	Hermiston Stanfield	Umatilla	\$2,381,000	Hermiston-Hinkle Road from Feedville Road to Highland Avenue. Widen, align, shoulder and pave rural section/urban upgrade.	Improve safety and operations	Unconstrained	Hermiston Stanfield Umatilla County	Long -term	Umatilla County TSP # 10 Hermiston TSP Improvement # 22
27	N/A	N/A	Local	5	Modernization	Stanfield	Umatilla	\$1,110,000	Edwards Road (County Road 1201) from US 395 North to Diagonal Road. Widen, align, shoulder and repave.	Improve safety and operations	Unconstrained	Umatilla County		Umatilla County/HUES Report 1998 Umatilla Co. TSP # 12
33	3.79	3.79	54	5	Modernization	Hermiston	Umatilla	\$6,300,000	Extend Punkin Center Road from US 395 west to the Umatilla River, construct new bridge and widen Pringle Road west of new bridge to Powerline Road.	Improve safety and operations	Unconstrained	Umatilla County	Near -term	Umatilla County TSP #22 Hermiston TSP Improvement # 4
41	N/A	N/A	Local	5	Modernization		Umatilla	\$600,000	Bensel Road from N. Ott to US 395 N. Reconstruct and pave.	Improve safety and operations	Unconstrained	Umatilla County		Umatilla County TSP #1
42	N/A	N/A	Local	5	Modernization	Hermiston	Umatilla	\$750,000	Upgrade 1st Street from Hermiston Avenue to Highland Avenue.	Improve operations	Unconstrained	Hermiston	Long -term	Hermiston TSP Improvement #20
43	N/A	N/A	Local	5	Modernization	Hermiston	Umatilla	\$4,171,500	Punkin Center Road from US 395 to Diagonal Road (Hermiston). Widen, align, shoulder and pave rural section/urban upgrade.	Improve safety and operations	Unconstrained	Umatilla County		HUES Transportation Study 1998 Umatilla Co. TSP # 7
44	N/A	N/A	Local	5	Modernization	Stanfield	Umatilla	\$394,500	Feedville Road, end of Wal-Mart road improvement west to Hwy 207. Widen, align, shoulder and repave.	Improve safety and operations	Unconstrained	Umatilla County		HUES Transportation Study 1998 Umatilla Co. TSP # 11
45	N/A	N/A	Local	5	Modernization	Hermiston	Umatilla	\$988,000	Theater Lane Phase I from US 395 N to East 7th Street alignment (Hermiston). City acquisition/urban upgrade.	Improve safety and operations	Unconstrained	Umatilla County	Long -term	Hermiston TSP Improvement # 17 Umatilla Co. TSP 19
46	N/A	N/A	Local	5	Modernization	Hermiston	Umatilla	\$1,195,000	Theater Lane Phase II. East 7th Street Alignment to East 10th Street (Hermiston). City acquisition/urban upgrade.	Improve safety and operations	Unconstrained	Umatilla County	Long -term	Hermiston TSP Improvement # 17 Umatilla Co. TSP 18
47	N/A	N/A	54	5	Modernization	Stanfield	Umatilla	\$545,000	US 395 access to Maime Street/Canal Road. New intersection with US 395 N. Construct new access and realign Canal Road approach and install traffic signal.	Improve safety and operations	Unconstrained	ODOT Stanfield		Stanfield TSP Umatilla Co. TSP # 27

FUNDING PRIORITY: Unconstrained														
Proj	BEG. MP	END MP	HWY	REG	WORKTYPE	CITY	COUNTY	ESTIMATED COST	DESCRIPTION	JUSTIFICATION	FUNDING CATEGORY	LEAD AGENCY	PRIORITY	SUPPORTING DOCUMENTATION
58			333	5	Modernization	Hermiston	Umatilla	\$1,000,000	Improve Elm Avenue (OR 207) from East 4th Street to Diagonal Rd. Widen to 3 lanes.	Improve operations	Unconstrained	ODOT	Mid-term	Hermiston TSP Improvement # 8
62			333	5	Modernization	Hermiston	Umatilla	\$250,000	Improve West 11th Street (OR 207) North of Highland Ave. Widen to 3 lanes.	Improve operations	Unconstrained	ODOT	Mid-term	Hermiston TSP Improvement #13
18	182.54	182.54	2	5	Operations	Umatilla	Umatilla	\$150,000	Powerline Road, intersection with US 730, traffic signal installation at intersection.	Improve safety and operations	Unconstrained	Umatilla County ODOT		City of Umatilla TSP and HUES Report 1998 # 4
20	183.61	183.61	2	5	Operations	Umatilla	Umatilla	\$130,000	Umatilla River Road (County Road 1275) intersection with US 730, install traffic signal.	Improve safety and operations	Unconstrained	Umatilla County ODOT		City of Umatilla TSP #6
52	12.05	12.05	54	5	Operations	Stanfield	Umatilla	\$226,000	Construct new access to US 395 N and realign Edwards Road	Improve safety and traffic flow	Unconstrained	ODOT Stanfield		Stanfield TSP Option 11
54	0.00	0.00	54	5	Operations	Umatilla	Umatilla	\$270,000	Construct a second northbound left-turn lane at the Hwy 395/Hwy 730 intersection.	Improve safety and capacity of intersection.	Unconstrained	ODOT Umatilla	Long -term	Umatilla TSP # 2
61			333	5	Operations	Hermiston	Umatilla	\$300,000	Improve Elm Ave.(OR 207)/Umatilla River Rd. Intersection including left turn lane and signal modifications.	Improve operations	Unconstrained	ODOT	Mid-term	Hermiston TSP Improvement # 12
40	N/A	N/A	Local	5	Safety	Hermiston	Umatilla	\$2,654,000	East 10th Street, from Elm Avenue to Punkin Center Road. Urban upgrade.	Improve safety and operations	Unconstrained	Hermiston	Long -term	Region 5 SNASP List Hermiston TSP Improvement #16
19	182.60	182.60	2	5	Bridge	Umatilla	Umatilla	\$2,000,000	Powerline Road and US 730 intersection. Reconstruct Umatilla River Bridge, provide grade separation for the Powerline Road/Highway intersection.	Improve safety and operations	Unconstrained	Umatilla County ODOT		City of Umatilla TSP and HUES Report 1998 #5
3	12.68	Echo City Limits	Local	5	Bicycle Pedestrian	Echo	Umatilla	\$1,081,560	Widen Thielsen Road to 36' to allow for two 12' travel lanes and 6'wide paved shoulders. Include a 6' wide raised sidewalk across the I-84 overpass. County Bridge No. 59C703 (over Furnish Ditch) and County Bridge No. 59C704 (over Feed Canal) replacement.	Improve safety	Unconstrained	Echo Umatilla County		Echo TSP
56			54	5	Bicycle Pedestrian	Umatilla	Umatilla	\$235,000	Construct US 395 North pathway from US 730 to Bowdin.	Improve bicycle and pedestrian movement.	Unconstrained	ODOT Umatilla	Long -term	Umatilla TSP # 1
70	N/A	N/A	Local	5	Bicycle	Hermiston	Umatilla	\$2,300	East 4th Street (Main Street to US 395). Stripe bike lanes.	Improve bicycle circulation.	Unconstrained	Hermiston	Mid-term	Hermiston TSP
71	N/A	N/A	Local	5	Bicycle	Hermiston	Umatilla	\$2,900	East 4th Street (Elm Avenue to Main Street). Stripe bike lanes.	Improve bicycle circulation.	Unconstrained	Hermiston	Mid-term	Hermiston TSP
72	N/A	N/A	Local	5	Bicycle	Hermiston	Umatilla	\$28,600	Elm Avenue (West 7th Street to US 395) Stripe Bike lanes.	Improve bicycle circulation.	Unconstrained	Hermiston	Mid-term	Hermiston TSP
73	N/A	N/A	Local	5	Bicycle	Hermiston	Umatilla	\$217,000	East 10th Street (Elm Avenue to Highland Avenue) Widen to 34 ft. and Stripe 6 ft bike lanes.	Improve bicycle circulation.	Unconstrained	Hermiston	Mid-term	Hermiston TSP
74	N/A	N/A	Local	5	Bicycle	Hermiston	Umatilla	\$217,000	NE 10th Street (Theater to Elm Avenue) Widen from 22 ft. to 32 ft. with 5 ft. shoulder.	Improve bicycle circulation.	Unconstrained	Hermiston	Mid-term	Hermiston TSP
75	N/A	N/A	Local	5	Bicycle	Hermiston	Umatilla	\$175,000	Theater Lane (NW Gear to NE 7th St. Alignment) Widen from 22 ft. to 32 ft. with 5 ft. shoulders.	Improve bicycle circulation.	Unconstrained	Hermiston	Long -term	Hermiston TSP
76	N/A	N/A	Local	5	Bicycle	Hermiston	Umatilla	\$223,000	Highland Avenue (Umatilla River to SW 11th Avenue) Widen 28 to 34 ft. with 6-ft shoulders.	Improve bicycle circulation.	Unconstrained	Hermiston	Long -term	Hermiston TSP

FUNDING PRIORITY: Unconstrained

Proj	BEG. MP	END MP	HWY	REG	WORKTYPE	CITY	COUNTY	ESTIMATED COST	DESCRIPTION	JUSTIFICATION	FUNDING CATEGORY	LEAD AGENCY	PRIORITY	SUPPORTING DOCUMENTATION
48	N/A	N/A	Local	5	Pedestrian		Umatilla	\$442,000	Bensel Road sidewalks from Umatilla River road to US 395 North.	Improve accessibility	Unconstrained	Umatilla County		Umatilla County TSP
49	N/A	N/A	Local	5	Pedestrian	Umatilla	Umatilla	\$823,000	Powerline Road sidewalks from US 730 to south UGB.	Improve accessibility	Unconstrained	Umatilla County		Umatilla County TSP
50	N/A	N/A	Local	5	Pedestrian	Umatilla	Umatilla	\$642,000	Umatilla River Road sidewalks from US 730 to Bensel Road.	Improve accessibility	Unconstrained	Umatilla County		Umatilla County TSP
65	N/A	N/A	Local	5	Pedestrian	Hermiston	Umatilla	\$59,000	East 4th Street (Elm Avenue to Highland Avenue). Sidewalk infill, 28 curb ramps.	Improve pedestrian movement.	Unconstrained	Hermiston	Near -term	Hermiston TSP
66	N/A	N/A	Local	5	Pedestrian	Hermiston	Umatilla	\$140,000	East 10th Street (Elm Avenue to Highland Avenue) Sidewalk Infill.	Improve pedestrian movement.	Unconstrained	Hermiston	Near -term	Hermiston TSP
67	N/A	N/A	Local	5	Pedestrian	Hermiston	Umatilla	\$14,000	Highland Avenue (SW 11th Street to SE 5th Street) Sidewalk Infill.	Improve pedestrian movement.	Unconstrained	Hermiston	Mid-term	Hermiston TSP
68	N/A	N/A	Local	5	Pedestrian	Hermiston	Umatilla	\$57,000	1st Street (Hermiston Avenue to Highland Avenue) Sidewalk infill, 10 curb ramps.	Improve pedestrian movement.	Unconstrained	Hermiston	Mid-term	Hermiston TSP
69	N/A	N/A	Local	5	Pedestrian	Hermiston	Umatilla	\$123,000	Elm Avenue (West 7th Street to US 395) Construct Sidewalks	Improve pedestrian movement.	Unconstrained	Hermiston	Mid-term	Hermiston TSP

Total Unconstrained=	\$41,486,960
Total Modernization =	\$31,274,600
Local Network =	\$22,734,400
GRAND TOTAL =	\$60,965,575



LOCATIONS OF SOLUTIONS

KEY TO FUNDING

- COMMITTED
- CONstrained
- STRATEGIC
- UNCONSTRAINED

RURAL GENERAL ZONING

- Rural Residential
- Rural Industrial
- Agricultural

- KEY TO BOUNDARIES**
- CITY LIMITS
 - URBAN GROWTH

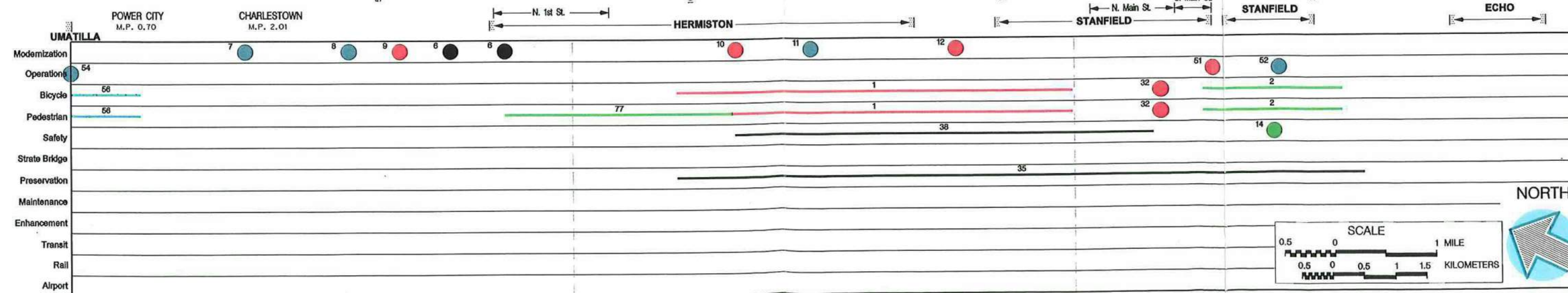
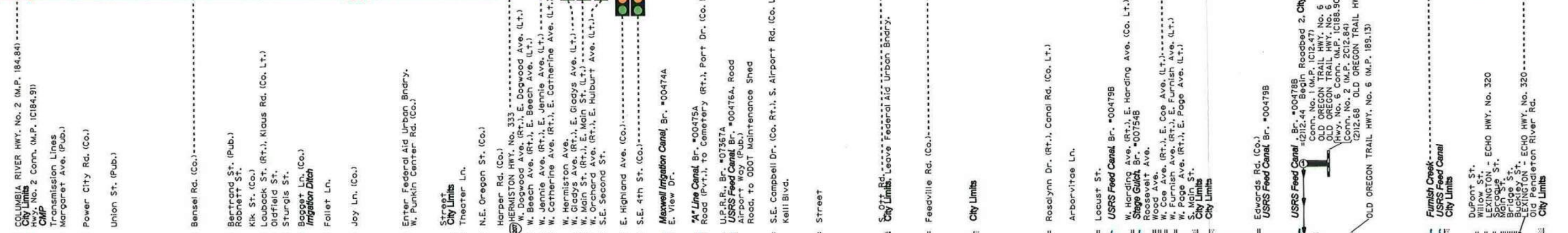
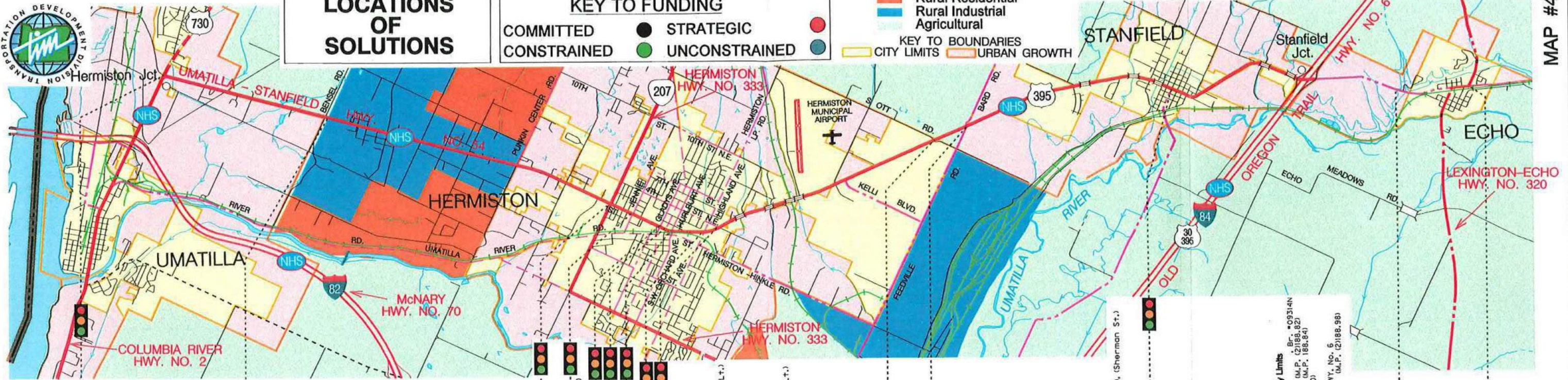



LOCATIONS OF OFF SYSTEM SOLUTIONS

KEY TO FUNDING

● COMMITTED	● STRATEGIC
● CONSTRAINED	● UNCONSTRAINED

?? PROJECT NUMBER

KEY TO BOUNDARIES

— CITY LIMITS

— URBAN GROWTH

MAP #5

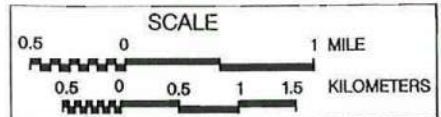
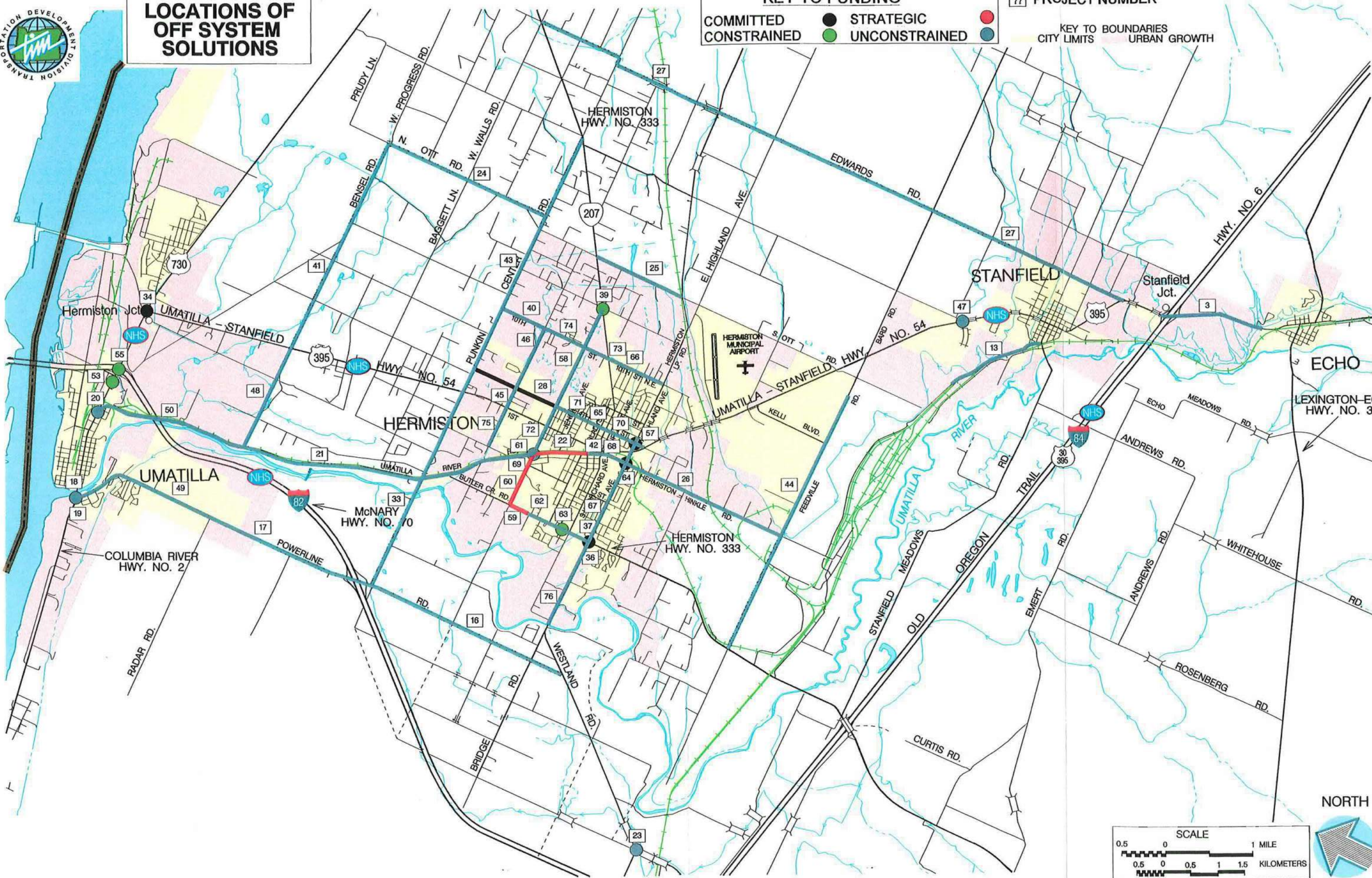

Excerpts

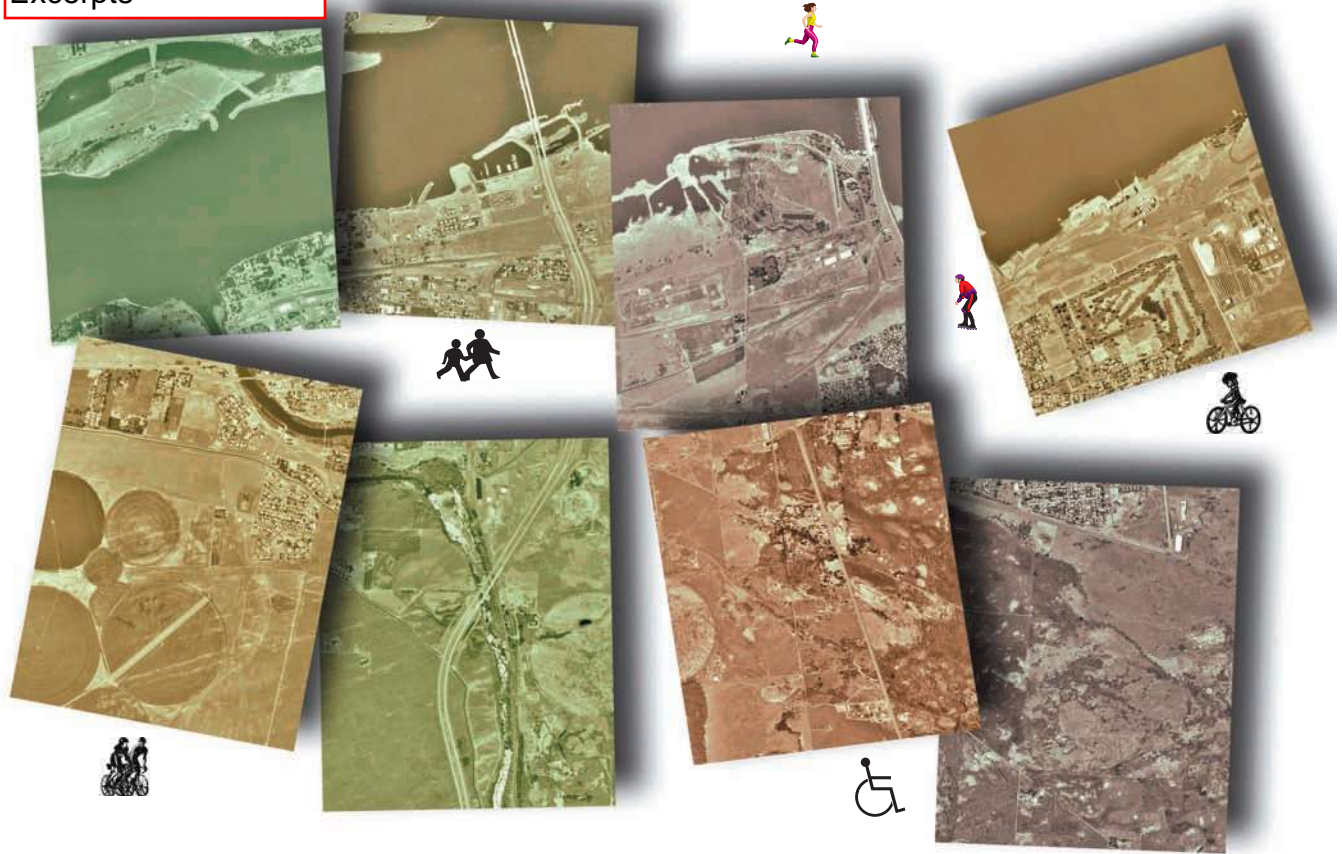

Umatilla

Pedestrian & Bicycle

MASTER PLAN

June 3, 2003

Contents

Chapter 1 — Scope	5
Chapter 2 — Background Research	6
2.1 Sources	6
2.2 Area Description	6
2.3 Jurisdictions	6
2.4 Nonmotorized Traffic Generators	7
2.5 Implementation Plan	9
Chapter 3 — Inventory	10
3.1 Street System	10
3.2 Pedestrian Facilities	11
3.3 Bicycle Facilities	12
Chapter 4 — Systemwide Factors	14
4.1 Natural and Manmade Barriers	14
4.2 Development Pattern	14
4.3 Street Standards and Development Codes	15
4.4 Funding	17
Chapter 5 — Neighborhood Analysis	23
5.1 Project Evaluation Criteria	23
5.2 South Hill Projects	26
5.3 Downtown Umatilla Projects	36
5.4 Central Area Projects	41
5.5 McNary Projects	45
Chapter 6 — Capital Improvement Program	49
Appendix A — Glossary	A-1
Appendix B — Pedestrian & Bicycle System Maps	B-1
Appendix C — Transportation SDC Example	C-1
Appendix D — General Plan and Code Amendments	D-1
Appendix E — Inter-Jurisdictional Agreements	E-1
Appendix F — Traffic Analysis	F-1
Appendix G — Engineering Design Standards	G-1
G.1 Pedestrian Facilities	G-1
G.2 On-Road Bicycle Facilities	G-5
G.3 Multi-Use Paths	G-8
G.4 Signs, Pavement Markings and Signals	G-11

Figures

1.	South Hill	26
2.	Proposed Connector & Extension Paths	28
3.	Proposed Connector Path — Design Details	29
4.	Typical Traffic Calming Measures	33
5.	School Access Using a Roundabout	34
6.	Downtown	36
7.	Central Area	41
8.	McNary	45

Tables

1.	TSP Implementation Plan	9
2.	Existing Street System	10
3.	Project Rating Matrix	25
4.	TSP Implementation Plan (repeat of Table 1)	49
5.	Proposed Pedestrian-Bicycle CIP	50



McNary Dam

Table 3 shows a qualitative rating of these criteria. The last column shows the overall feasibility of the project. The following text examines each project in more detail and establishes the period of completion (near-term, long-term), the cost, the funding authority, and potential funding. Complicated projects such as the Powerline Road Improvements are broken down into elements.

Because these projects span a wide range of needs and level of development, it is difficult to compare them directly. Some are specific facility projects (such as the various path segments), others cover an area or corridor (such as downtown walkway infill or 3rd Street corridor), while yet others are planning initiatives (such as the Umatilla River Bridge). Together, they represent system needs over the next 20 years.

Table 3
Project Rating Matrix

Project	①	②	③	④	⑤	⑥	⑦	Feasibility
	Relevance	LOS	Cost	Funding	Technical	Political	Use	
	<div style="border: 1px solid black; padding: 5px; display: inline-block;"> ◆ = Poor ◆◆ = Fair ◆◆◆ = Good </div>							
South Hill								
🚶 Ped. Bridge to Powerline Rd Path	◆◆◆	◆◆◆	◆◆	◆◆	◆◆	◆◆◆	◆◆◆	High
🚶 Lower South Hill Extension Path	◆◆◆	◆◆◆	◆◆◆	◆◆	◆◆◆	◆◆◆	◆◆◆	High
🚶 Umatilla Bridge Undercrossing Path	◆◆	◆◆◆	◆◆◆	◆◆	◆◆	◆◆◆	◆◆	High
🚶 Powerline Road Improvements	◆◆◆	◆◆◆	◆	◆	◆◆	◆◆	◆◆◆	Medium
🚶 Future Elementary School and Park	◆◆◆	◆◆	◆◆	◆	◆◆	◆	◆◆◆	Medium
🚶 Umatilla River Bridge	◆◆	◆◆	◆◆◆	◆	◆◆	◆◆	◆◆	Medium
Downtown Umatilla								
🚶 3rd Street Path to River Path	◆◆◆	◆◆	◆◆	◆◆	◆◆	◆◆◆	◆◆◆	High
🚶 Walkway Infill	◆◆◆	◆◆	◆◆	◆◆	◆◆	◆◆	◆◆◆	Medium
🚶 Old Umatilla Connectors	◆◆	◆◆◆	◆◆	◆	◆	◆	◆◆	Low
Central Area								
🚶 3rd Street Corridor	◆◆	◆◆	◆◆	◆	◆◆◆	◆◆	◆	Medium
🚶 Crossroads Intersection	◆◆	◆◆◆	◆◆◆	◆◆	◆◆	◆	◆	Medium
McNary								
🚶 Devore Road Connection	◆◆	◆	◆◆◆	◆	◆◆	◆	◆	Low
🚶 Dam Overlook Improvements	◆◆	◆◆	◆◆◆	◆	◆◆	◆◆	◆◆	Medium
🚶 Future Park Connectors	◆◆	◆◆◆	◆◆	◆	◆◆	◆◆◆	◆◆◆	Medium

5.2 South Hill Projects

The South Hill area is the newest residential area of Umatilla. Located roughly along the top of the plateau above Umatilla, its development pattern is typical of more recent subdivisions, with large lots and long blocks that feed onto one major street, Powerline Road. Newer streets

have sidewalks. There are no commercial services or schools currently available within the South Hill area, although an elementary school and park are planned for the near future and some areas are zoned for neighborhood commercial.

Downtown and South Hill are separated by the Umatilla River. Two bridges connect the neighborhoods, an aging structure to the north on Highway 730 and a conveniently located pedestrian bridge. Neither bridge is well connected by sidewalks, although the pedestrian bridge has a multi-use path on the Downtown (north) side.

Major opportunities in South Hill include improving access to the pedestrian bridge, constructing sidewalks and bike lanes on Powerline Road, developing a bicycle-friendly and walkable school/park site, and eventually acquiring the historic highway bridge for pedestrian and bicycle use.

The four primary projects described below are related but can be pursued independently. These four projects received the highest interest of any projects at the public workshop.

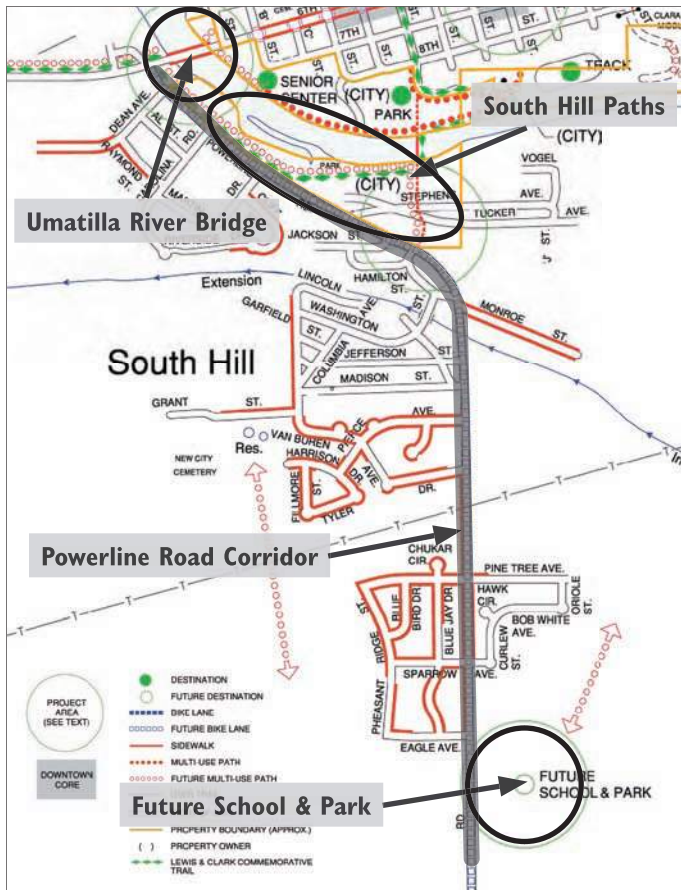

Figure 1
South Hill

The maps in this section are for orientation. See Appendix B for map detail.

5.2.1 Lower South Hill Paths

The pedestrian bridge over the Umatilla River below “F” Street provides a key shortcut between South Hill and the downtown and schools. Its utility has been limited by a poor connection to Powerline Road. Three path segments provide an opportunity to greatly improve access to the bridge.

Connector Path from Pedestrian Bridge to Powerline Road

- ❖ **Description:** construct a paved path between the existing pedestrian bridge over the Umatilla River and Powerline Road at Hamilton Street.
- ❖ **Period of completion:** near-term.
- ❖ **Cost:** 1560 ft 10-ft wide path, \$105k including excavation.
- ❖ **Ownership:** City.
- ❖ **Funding authority:** City.
- ❖ **Funding sources:** general funds, grants, school transportation fund.
- ❖ **Feasibility:** high.

Currently, many users reach the bridge from Powerline Road via a steep, unimproved trail which trespasses over a corner of private

5.3 Downtown Projects

The downtown consists of the older part of Umatilla along Highway 730 from the Umatilla River Bridge to Umatilla River Road. The core reflects the traditional grid of blocks typical of older downtowns, with some residential development and a more highway-oriented pattern at the edges. The downtown area also includes Old Umatilla to the north, an abandoned town section owned by the Army Corps of Engineers and inaccessible due to fencing.

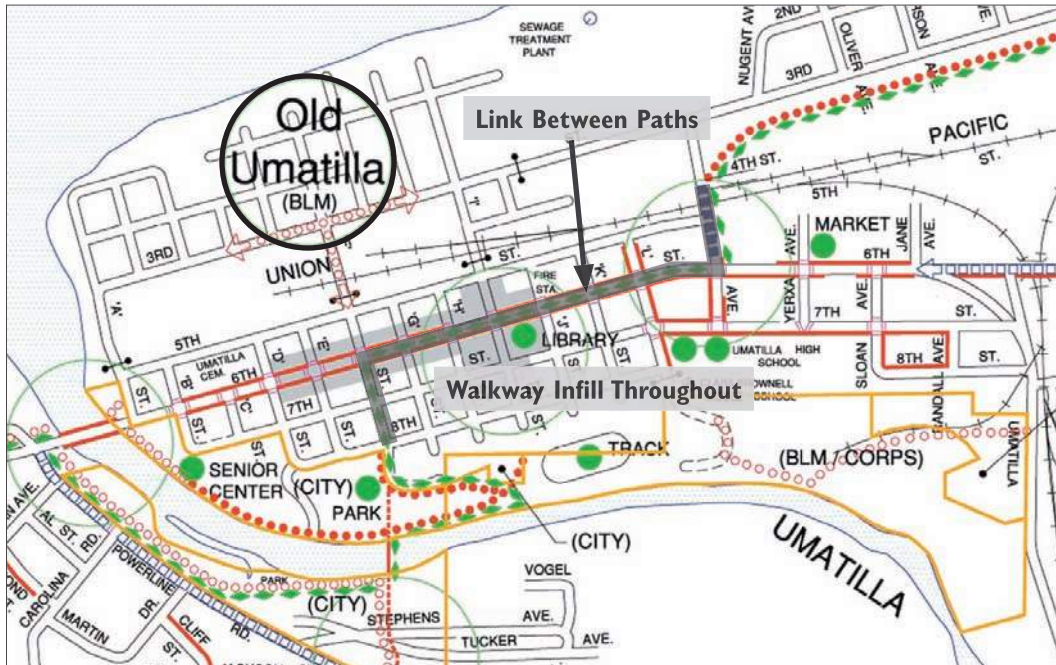

Figure 6
Downtown

Many downtown enhancements are covered in the 2001 Downtown Study. The Study designated the intersection of 7th and “I” Streets for a future civic center with “I” Street receiving special pedestrian-oriented features. This fundamental change in the development pattern will take many years to develop but should be supported by other opportunities such as completing missing links in the Downtown pathway network, improving walkways and bikeways, and potential development of Old Umatilla into a park.

The TSP recommended \$422,000 in near-term sidewalk projects in the downtown on Highway 730 (Switzler to Brownell) and on “D,” “F,” “I,” “L,” and 7th Streets.

5.3.1 Link the 3rd Street and Umatilla River Paths

- ❖ **Description:** develop route between existing paths.
- ❖ **Period of completion:** near-term.
- ❖ **Cost:** 400 ft of 6-ft wide sidewalks (both sides) and bike lanes (one side) on Switzler Avenue, \$37k; 5000 ft bike lanes on Highway 730 in downtown at \$0.80/ft, \$10k; 500 ft of 5-ft sidewalks on “F” Street, \$25k; zebra crosswalks with median islands at Switzler, \$6k; signage, \$1k; \$79k total.
- ❖ **Ownership:** City.
- ❖ **Funding authority:** City, ODOT.
- ❖ **Funding sources:** City, grants, ODOT, developers.
- ❖ **Feasibility:** high.

Two existing paths, the 3rd Street Path and the Umatilla River Path, are separated by a 0.5-mile gap in the downtown. (Note that this is also the route of the Lewis and Clark Trail.) Although creating a separated path is not feasible in the downtown core, several things can be done to make it easier for people to continue from one path to the other:

5.4 Central Area Projects (Between Downtown and McNary)

McNary and Downtown are separated by approximately two miles. A portion of this area is zoned Public Facilities and is associated with the dam and Army Corps of Engineers land, including a large wetland reserve. It is unlikely that this area will see significant infill development over the next 20 years to expand the urban area. Therefore, connection between McNary and Downtown will remain an important transportation consideration.

The area is bisected by I-82 which can be crossed in only two places: the 3rd Street underpass and the Highway 730 interchange.

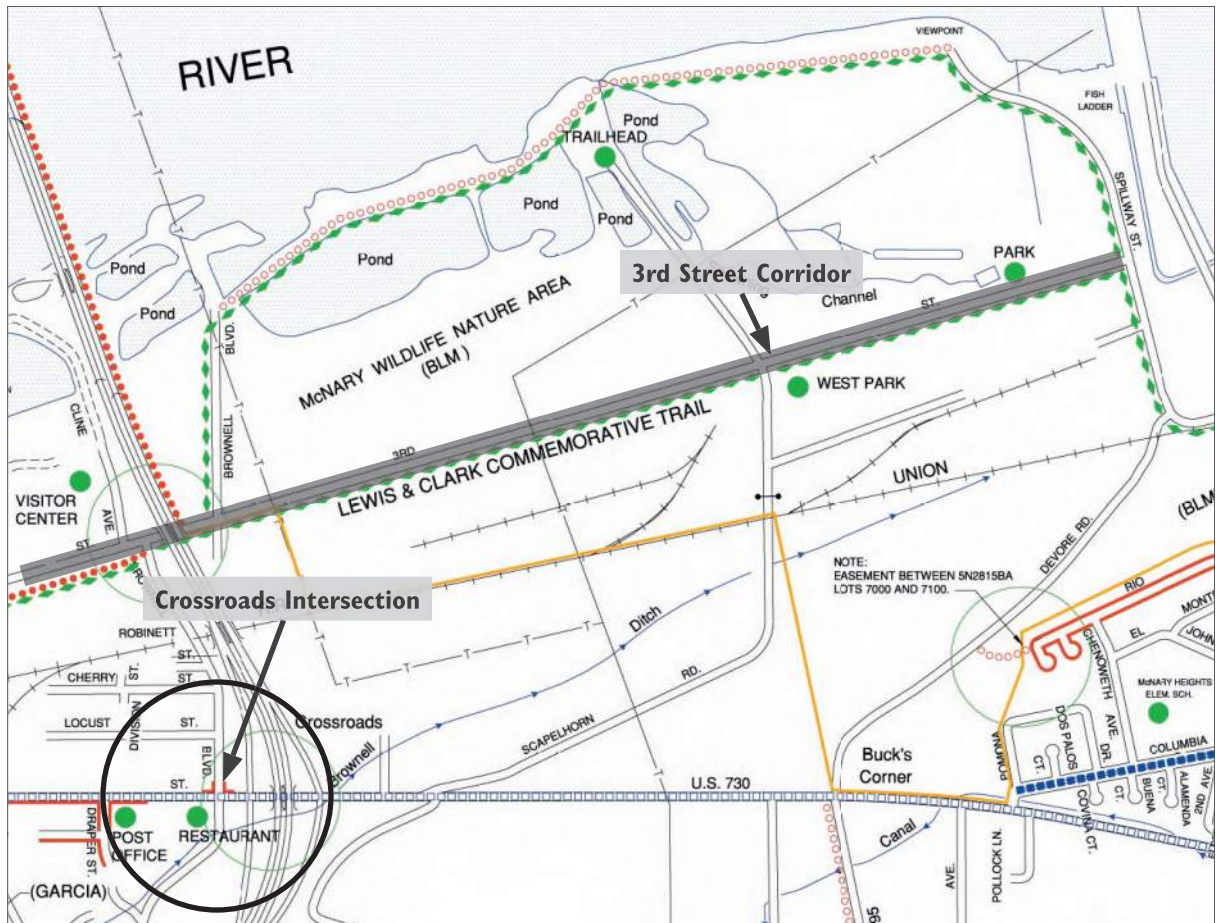

Figure 7
Central Area

Although most of Highway 730 includes shoulders, there is little lighting, especially for nonmotorists, and intersections are all difficult to traverse. Opportunities for improvements to Highway 730 and its intersections are described in the Downtown Study and in the TSP.

Parallel to Highway 30 runs 3rd Street which is a 2-lane County road without paved shoulders. It is part of the future Lewis & Clark Trail and connects to numerous destinations.

There are three north-south connectors between 3rd Street and Highway 730: Brownell Boulevard, Scapelhorn Road and Devore Road. The TSP recommended a near-term sidewalk project on Brownell Boulevard. Devore Road could provide another connection to the McNary neighborhood (refer to Section 5.5.1).

5.5 McNary

The McNary Townsite was area platted and developed by the Army Corps of Engineers in conjunction with the dam construction from 1947-53. Streets were named for tributaries of the Columbia River. McNary constitutes a somewhat self-sufficient neighborhood with a school, golf course and small commercial area including a market.

There are two broad “boulevards” and a grid of local streets characteristic of traditional towns. Although there are few sidewalks or bicycle lanes, residents of McNary are reportedly comfortable walking and bicycling on the local streets. The difficulty comes in traveling outside the town.

The TSP recommended \$600,000 in near-term sidewalk projects in McNary for Willamette Avenue, Columbia Street, John Day Street, Chinook Avenue, Lake Gordon Avenue, and Chenoweth Avenue. These are mostly around the elementary school.

“We must plan towns in the name of our great nation, for the United States of America, and we must do the very best that we can within the limitations imposed by the yard-sticks of economics and human values — placing all possible emphasis upon the latter. Anyway, if we can afford it, if we can come reasonably near to monitoring its cost, what is wrong with Utopia?” – John M. Allison, McNary Town Manager, 1946

**Figure 8
McNary**

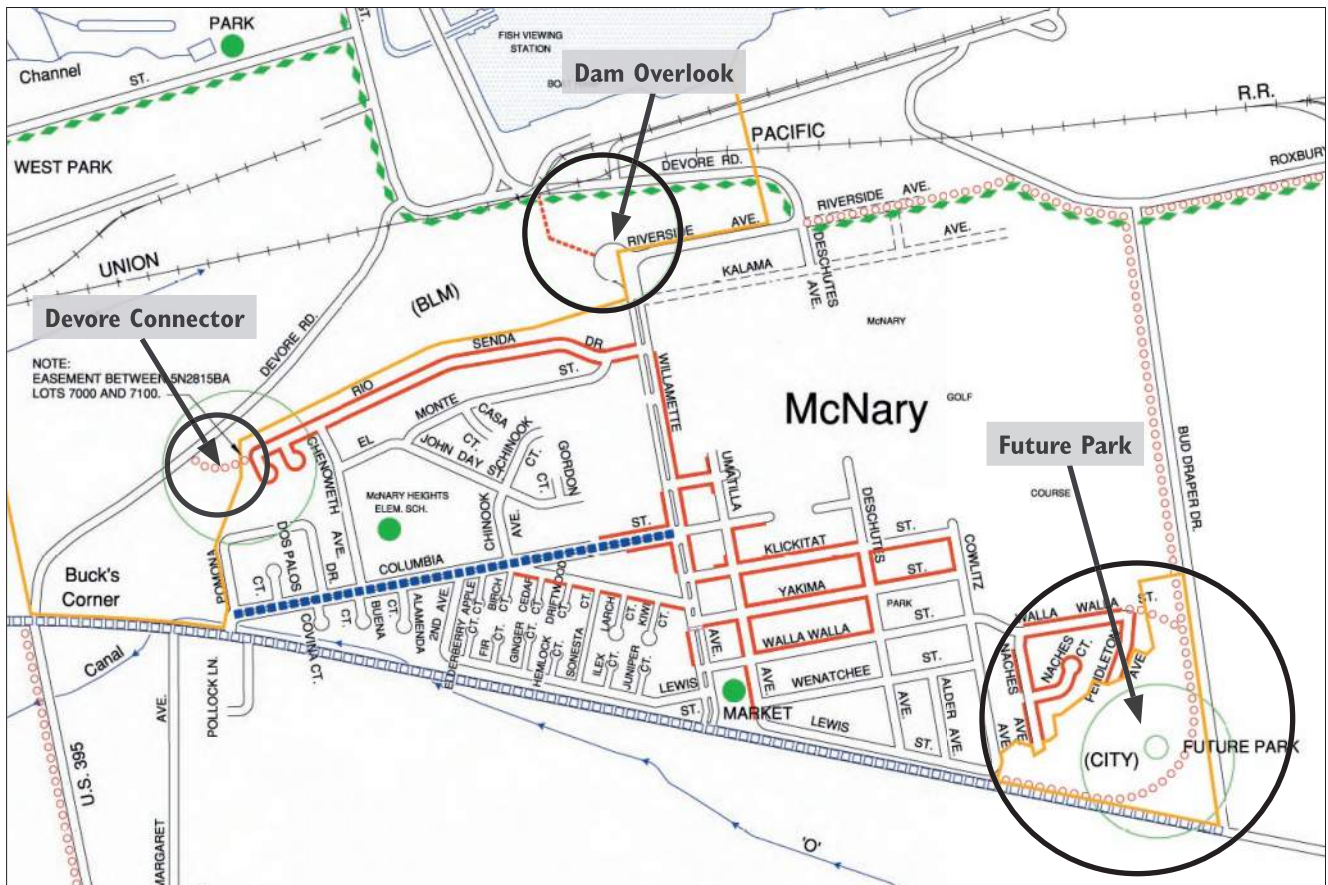

6

Capital Improvement Program

The TSP implementation plan, summarized in Table 4 (repeat of Table 1 for convenience), is a starting point for a specific pedestrian and bicycle Capital Improvement Plan (CIP). The 20-year plan outlined in the TSP lists 54 projects estimated to cost nearly \$15 million. By far the greatest need identified was sidewalks with 37 projects totaling \$9.35 million. There are another 8 multi-use path projects totaling \$1.33 million.

Over half of the roadway project cost is for replacing the Umatilla River bridge. The remainder of the roadway system needs relatively minor improvements according to the TSP. However, many county roads, such as Powerline Road, were not included, most of which have less than 24 ft of pavement width — far below the standard for arterial and collector streets. The additional width is particularly important to bicyclists and pedestrians.

The TSP did not provide a fiscally-constrained plan from which to work. It notes that the City’s annual Street Fund of \$250,000 is dedicated entirely to the operation and maintenance of existing facilities. The few capitol improvement projects realized in the past were funded primarily by the developer or by a Local Improvement District. The TSP recommended a transportation system development charge supplemented by a combination of other sources such as street bonding, local improvement districts, a local gas tax, hotel/motel tax, and a street utility fee.

The TSP showed funding responsibilities of roughly \$5.3M for ODOT (including most roadway projects), \$5.6M for the County, \$3.0M for the City, and \$0.5M for the Army Corps of Engineers. This demonstrates the large number of roads in the urban area that are under County jurisdiction. The County has no plans and very limited funding to improve these facilities, so any projects must be undertaken by the City.

Table 4. TSP Implementation Plan

Project Category	Short-Term (1998-2007)		Long-Term (2008-2017)		Total	
	Projects	Cost, \$M	Projects	Cost, \$M	Projects	Cost, \$M
Roadway	2	\$0.29	7	\$3.40	9	\$3.69
Sidewalk	13	\$1.16	24	\$8.19	37	\$9.35
Multi-Use Path	0	0	8	\$1.33	8	\$1.33
Total	15	\$1.45	39	\$12.92	54	\$14.37

Because the City has no Capital Improvement Program, the list of projects in Table 5 is derived from the discussion in Section 5. These are considered the most promising pedestrian and bicycle projects for the City to undertake. Although the projects focus on specific facilities such as sidewalks and multi-use paths, they also include the key Powerline Road and 3rd Street corridors. Many of the projects support the Lewis & Clark Trail.

The estimated cost of these capital improvement projects is \$2140k, assuming a signal installation at the Powerline Road-Highway 730 intersection. The cost is evenly split between near- and long-term projects. About \$1600k would be City funded or about \$80k per year over 20 years.

Left out of the list are potential projects that did not make the cut but were included on the system map for planning purposes and future consideration. Some of these may become practical sooner than anticipated if unexpected development occurs or a project advocate appears.

Finally, several multi-jurisdictional planning initiatives should be included in the City's efforts:

- South Hill school and park.
- Umatilla River Bridge replacement.
- Old Umatilla park and trail development.

Table 5. Proposed Pedestrian-Bicycle CIP

Project	Description	Period	Cost, \$k	Authority
Umatilla River Paths				
Ped. Bridge to Powerline Rd. Path	1560 ft multi-use path 10-ft wide	Near	105	City
Lower South Hill Extension	1200 ft multi-use path 10-ft wide	Near	26	City
Umatilla Bridge Undercrossing	1500 ft multi-use path 10-ft wide	Long	18	City
Umatilla River Path Extension	700 ft multi-use path 10-ft wide	Near	15	City
Powerline Road Improvements				
Intersection with Highway 730	Signal near-term; bridge long-term	Near-Long	150–2000	ODOT
Sidewalks & Bike Lanes	4400 ft sidewalks & curbs both sides; 16-ft roadway widening	Near-Long	725	County
Traffic Calming & Crossings	6 crosswalks & islands; 1 roundabout	Near-Long	165	County
Downtown				
Link 3rd St. & Umatilla River Paths	900 ft sidewalks & curbs; 5000 ft bike lanes; crossing treatments	Near	79	City, ODOT
Walkway Infill	Various sidewalk segments; 700 ft multi-use path	Near-Long	415	City, ODOT
Central Area				
3rd St. Corridor	13,000 ft unpaved path	Long	130	USACE
Crossroads Intersection	2200 ft sidewalk & curb one side	Near	74	ODOT
McNary				
Devore Rd. Connector	400 ft unpaved path	Long	6	City, USACE
Dam Overlook	600 ft trail; RR Xing repair	Long	114	City, USACE, Port (RR)
Future Park Connectors	5300 ft multi-use path	Long	117	City

**Figure B-4
Central Area Map**

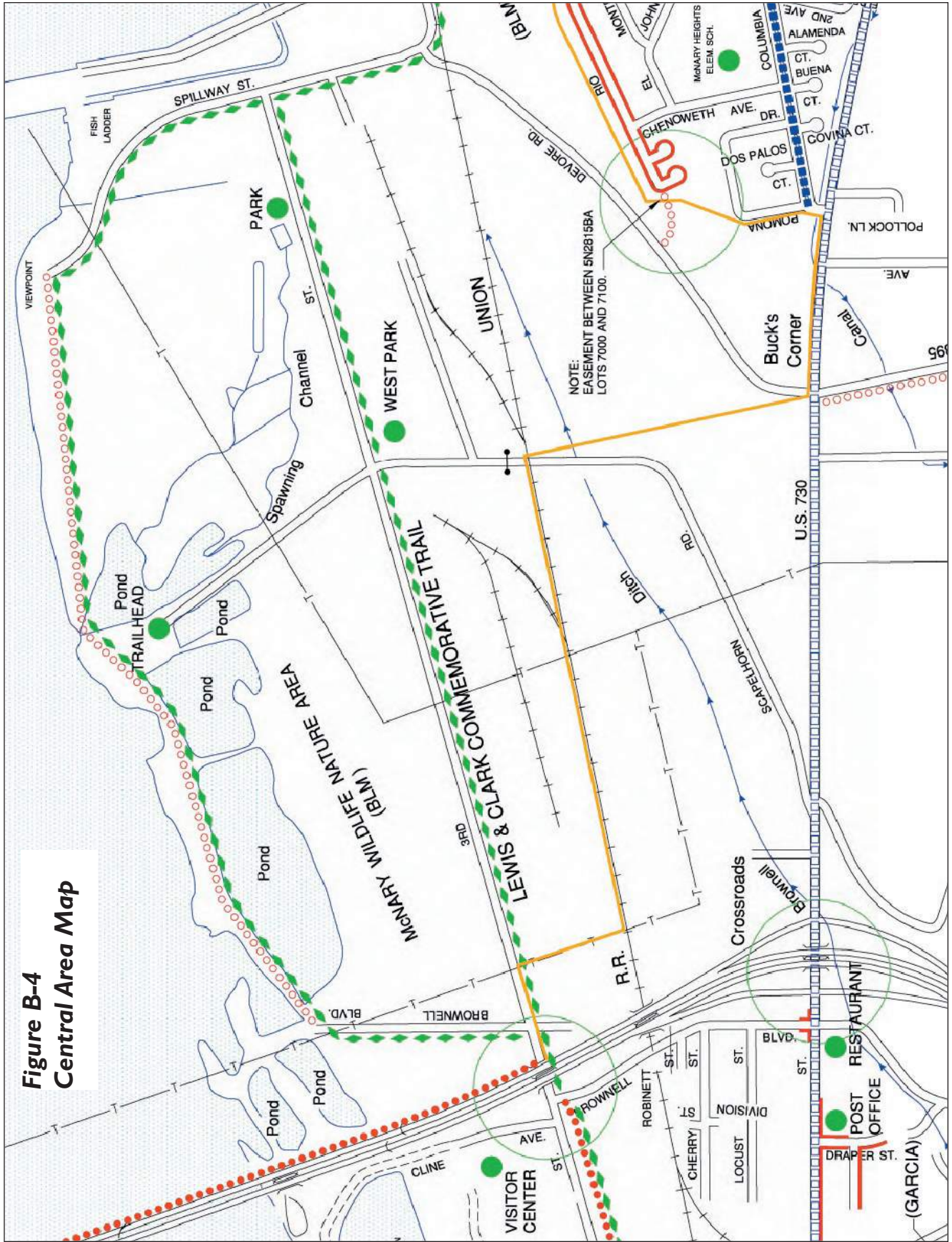

**Figure B-5
McNary Map**

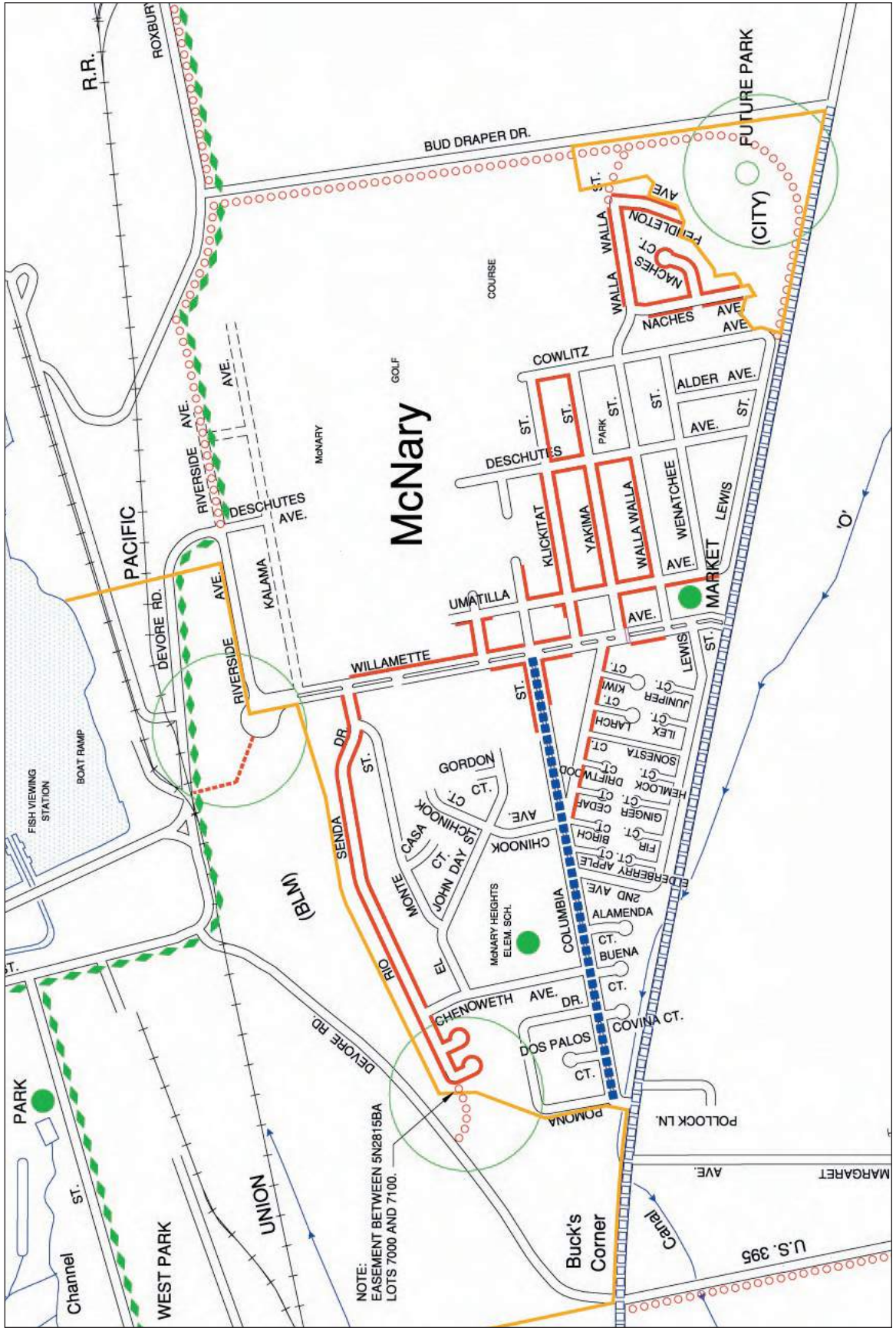

Excerpts

US 730 Corridor Refinement Plan

October 2007

Prepared For:
The Oregon Department of Transportation
Region 5
3012 Island Ave
La Grande, OR 97850

Prepared By:
Kittelson & Associates, Inc.
610 SW Alder, Suite 700
Portland, OR 97205
(503) 228-5230

Project No. 8212.00



Table of Contents

List of Figures 7

List of Tables 8

Preface 10

Section 1 - Introduction 13

 Study Area..... 13

 Development of the Corridor Refinement Plan..... 15

 US 730 Corridor refinement plan organization 15

Section 2 - Plans and Policy Review 19

 Regulatory Context..... 19

 1999 Oregon Highway Plan 20

 Morrow County Policy Documents 22

 Umatilla County Policy Documents 23

 City of Umatilla Policy Documents..... 24

 Miscellaneous Planning and Policy Information 24

Section 3 - Transportation/Land Use Inventory of Existing Conditions 29

 US 730 Corridor Refinement Plan Study Area 29

 Existing Land Use Inventory 29

 Existing Transportation Inventory 30

 Existing Traffic Volumes 37

 Traffic Safety 37

 US 730 Existing Roadway Access Inventory..... 44

Section 4 - Forecast Future Travel Demand 47

 Planned Transportation Improvements 47

 Future Transportation Demand 47

Section 5 - Circulation and Access Opportunities & Constraints Analysis.. 57

Overview..... 57

Existing Access Management Policies and Guidelines 57

General Access Management Strategies/Techniques for State Highways..... 59

Potential Near-Term/Low-Impact Circulation, Access, and Safety Strategies .. 60

Potential Longer-Term/Highway-Impact Circulation, Access, and Safety Strategies..... 66

Alternatives Comparison..... 95

Recommended Alternative..... 95

Section 6 - US 730 Corridor Refinement Plan..... 99

Overall Benefits of the US 730 Planning Effort 99

Study Corridor Circulation Plan..... 99

Prioritized US 730 Improvement Plan..... 100

Access Management Plan 116

Transportation Funding Plan..... 124

US 730 Corridor Refinement Plan Implementation..... 125

Appendix A – PPMT and Public Involvement Meeting Summaries 129

Appendix B – Zoning Codes..... 133

Appendix C – Existing US 730 Access Inventory..... 141

Appendix D – Existing Access Management Policy 159

1999 OREGON HIGHWAY PLAN 159

Appendix E – OAR 734-051-0155 Compliance Tables..... 167



List of Figures

Figure 1	US 730 Study Area Map	14
Figure 2	US 730 Sub Area Map.....	31
Figure 3	US 730 Study Area Zoning Designations	33
Figure 4	Existing Average Daily Traffic Volumes	39
Figure 5	US 730 Corridor Crash History (2001-2005)	41
Figure 6	2017 Future Daily Traffic Conditions	51
Figure 7	2027 Future Daily Traffic Conditions	53
Figure 8	Center-Turn-Lane Alternative.....	67
Figure 9	Center-Turn-Lane Alternative (Continued).....	69
Figure 10	Center-Turn-Lane Alternative (Continued).....	71
Figure 11	Typical Three Lane Highway Cross Section	74
Figure 12	Frontage Road Development Alternative	77
Figure 13	Frontage Road Development Alternative(Continued).....	79
Figure 14	Frontage Road Development Alternative (Continued).....	81
Figure 15	Frontage Road Cross Section Options	83
Figure 16	Limited Access Hybrid Alternative	87
Figure 17	Limited Access Hybrid Alternative (Continued)	89
Figure 18	Limited Access Hybrid Alternative (Continued)	91
Figure 19	Limited Access Hybrid Cross Section Example	94
Figure 20	Segment “A” Transportation Plan	101
Figure 21	Segments “B”, “C”, & “D” Transportation Plan	103
Figure 22	Segments “D”, “E”, & “F” Transportation Plan	105
Figure 23	Near-Term US 730 Plan and Cross Section	114
Figure 24	Long-Term US 730 Plan and Cross Section.....	115

List of Tables

Table 1	ODOT Spacing Standards for Regional Highways (feet)	22
Table 2	Morrow County Access Management Standards	23
Table 3	Umatilla County Access Management Standards	24
Table 4	Key OTSAP Action Items	25
Table 5	Speed Limits Along US 730 Study Corridor	35
Table 6	Existing Transportation Facilities and Roadway Designations .	36
Table 7	Existing Average Daily Traffic Volumes	37
Table 8	US 730 Safety Corridor Summary Data (MP 176.6-182.6).....	38
Table 9	Crash Data Summary.....	43
Table 10	Future Vacant/Buildable Lands Assumptions	50
Table 11	Potential Near-Term Access Consolidations or Closures	62
Table 12	Qualitative Alternatives Comparison	95
Table 13	Recommended Long-Term Circulation & Access Components	96
Table 14	Segment “A” Transportation Improvement Implementation Plan (Morrow County).....	107
Table 15	Segment “B” Transportation Improvement Implementation Plan (Umatilla County).....	108
Table 16	Segment “C” Transportation Improvement Implementation Plan (Umatilla County).....	109
Table 17	Segment “D” Transportation Improvement Implementation Plan (Umatilla County).....	110
Table 18	Segment “E” Transportation Improvement Implementation Plan (Umatilla County).....	111
Table 19	Segment “F” Transportation Improvement Implementation Plan (Umatilla County).....	112
Table 20	Near-Term Access Management Implementation Plan (15 th Street to Pleasant View Road).....	118



**Table 21 Near-Term Access Management Implementation Plan
 (Pleasant View Road to East End of Study Corridor)..... 122**

Section 6 - US 730 Corridor Refinement Plan

In 2003, the Oregon Department of Transportation (ODOT) designated a portion of US 730 as a Safety Corridor. As a result of this designation, the US 730 Corridor Refinement Plan was developed to identify circulation and access management strategies that would address the corridor's near-term and long-term safety needs. As these strategies and the associated improvements are implemented over time through development and various capital improvement projects, it is anticipated that the highway segment will function in a manner that is consistent with the characteristics of a safe and efficient Regional Highway.

OVERALL BENEFITS OF THE US 730 PLANNING EFFORT

Currently characterized as having a significant number of individual access driveways and a limited supporting local roadway network; it is recognized that the ability of the US 730 study corridor in its present state to safely and efficiently accommodate local and through traffic is limited. For Umatilla County, Morrow County, and the City of Umatilla, the US 730 Corridor Refinement Plan is a planning tool that more clearly defines the future safety, access, and circulation characteristics of the highway corridor. Specifically, the US 730 Corridor Refinement Plan offers the following benefits:

- It identifies strategies and improvements to create a safe and efficient highway that can better accommodate local and through traffic.
- It is a planning tool that offers a systematic approach for ensuring consolidated access and circulation opportunities for developing/redeveloping corridor properties.
- It assists in the development of a long-term circulation system that meets the unique land use characteristics and travel modes of the US 730 corridor.

The remaining portions of this section present the individual plan elements of the corridor refinement plan, which include a future circulation plan, an access management plan, and an implementation plan. It is intended through the recommendations listed in this section, that Umatilla County, Morrow County, and the City of Umatilla will adopt specific elements of the US 730 Corridor Refinement Plan into their respective transportation system plans.

STUDY CORRIDOR CIRCULATION PLAN

The first element of the US 730 Corridor Refinement Plan is the study corridor circulation plan. The study corridor circulation plan consists of the development of a refined plan that describes the various circulation elements of the study corridor.

In an effort to improve the overall safety and mobility of the study corridor, an approach that addresses the long-term circulation and access through highway widening, long-term access control, and the establishment of a supporting local circulation system is the preferred plan. This overall concept is supported by the following:

- The majority of the US 730 study corridor lacks a local street network to support and serve the properties and businesses along the highway. The lack of a supporting network has resulted in a total of 122 different driveways and intersections along the study corridor.
- The study corridor has experienced a significant number of fatal or injury crashes that is higher than the statewide average for highways of similar size and character. As a result, the highway has been given a “Safety Corridor” designation. Of the crashes, a large majority involved rear end, turning movement, and fixed object collisions that occurred in the eastern half of the study corridor where there is greater development density and a higher number of public and private highway approaches.

PRIORITIZED US 730 IMPROVEMENT PLAN

The US 730 improvement plan outlines specific transportation system improvements that have been identified to improve the long-term safety, function, and capacity of the US 730 study corridor. Umatilla County, Morrow County, and the City of Umatilla have adopted Transportation System Plans with a roadway system component that provides guidance on how best to facilitate long-term travel within each jurisdiction. The US 730 Corridor Refinement Plan builds upon these existing plan documents through the provision of safety, circulatory, and access improvements that are specific to the US 730 study corridor.

The improvement plan addresses a 20-year planning horizon and identifies future roadway improvements. The purpose of identifying these future roadway improvements was to:

- Provide highway safety improvements along US 730 that will better accommodate both through traffic and local traffic.
- Provide a plan for limiting the amount of individual private driveway approaches to the highway through closure, consolidation, and modification;
- Provide for an appropriate supporting roadway infrastructure to serve those portions of the study area that have the potential to accommodate future development;
- Provide Morrow County with guidelines for roadway alignments as future development occurs along the highway corridor;

Under this guidance, a project list was developed based on the need to systematically address the safety issues of the study corridor. As a result of the consensus achieved through the US 730 Corridor Refinement Plan study efforts, a series of new transportation improvement projects have been identified. These improvement projects are broken down by segments and graphically illustrated in Figures 20 through 22. Tables 14-19 identify the projects relative to the figures, and provide detailed descriptions of the projects, the priority of the projects, and potential funding sources.



Figure 20 Segment "A" Transportation Plan



Figure 21 Segments "B", "C", & "D" Transportation Plan

Figure 22 Segments "D", "E", & "F" Transportation Plan

Table 14 Segment "A" Transportation Improvement Implementation Plan (Morrow County)

Segment "A"				
Timeframe	Map Reference Number	Circulation/Access Project	Implementation Threshold	Potential Funding Sources
Short-Term	A1	- Close non-permitted approaches to US 730.	- As part of initial of subsequent STIP project.	STIP
	A2	- Purchase and close existing reservations of access in which the affected property has reasonable alternative access to a public street or other legal approach.	- As part of initial or subsequent STIP project.	STIP
	A3	- Purchase access control.	- As part of initial or subsequent STIP project.	STIP
Mid-Term	A4, A5, A6, A7, A8, A9, A10, A11, A12	- Continue development of the local transportation network.	- When redevelopment occurs. - If Morrow County funding sources become available.	PDF, MCF
Long-Term	A4, A5, A6, A7, A8, A9, A10, A11, A12	- Continue development of the local transportation network.	- When redevelopment occurs. - If Morrow County funding sources become available.	PDF, MCF
	A13	- Widen highway to a three-lane cross section and install a raised median from the future 18 th Street Corridor to Pleasant View Road.	- If segment crash rate consistently exceeds the statewide average for similar highway segments.	STIP
	A14, A15	- Implement turning movement restrictions at future 19 th Street intersection and existing Rand Road.		

Note: Potential Funding Sources Include the Following:
 STIP – Statewide Transportation Improvement Program
 PDF – Private Development Funding
 MCF – Morrow County Funding



Table 15 Segment "B" Transportation Improvement Implementation Plan (Umatilla County)

Segment "B"				
Timeframe	Map Reference Number	Action Item	Implementation Threshold	Potential Funding Sources
Short-Term	B1	- Close non-permitted approaches to US 730.	- As part of initial or subsequent STIP project.	STIP
	B2	- Purchase and close existing reservations of access in which the affected property has reasonable alternative access to a public street or other legal approach.	- As part of initial or subsequent STIP project.	STIP
	B3	- Purchase access control.	- As part of initial or subsequent STIP project.	STIP
	B4	- Perform a formal passing sight distance investigation along US 730 in the vicinity of Fox Lane/Harborlite Road.	- As part of initial or subsequent STIP project.	STIP
Mid/Long-Term	B5	- Construct a south side frontage road access point at Fox Lane.	- If segment crash rate consistently exceeds the statewide average for similar highway segments.	STIP
	B6	- Construct a south side frontage road from Pleasant View Road to Fox Lane.		

Note: Potential Funding Sources Include the Following:
 STIP – Statewide Transportation Improvement Program



Table 16 Segment "C" Transportation Improvement Implementation Plan (Umatilla County)

Segment "C"				
Timeframe	Map Reference Number	Action Item	Implementation Threshold	Potential Funding Sources
Short-Term	C1	- Close illegal (not permitted) US 730 approaches.	- As part of initial or subsequent STIP project.	STIP
	C2	- Purchase and close existing reservations of access in which the affected property has reasonable alternative access to a public side street or other legal approach.	- As part of initial or subsequent STIP project.	STIP
	C3	- Widen highway to a full three-lane cross-section from Fox Lane to Moorlando Lane.	- As part of initial or subsequent STIP project.	
	C4	- Purchase access control.	- As part of initial or subsequent STIP project.	
Mid/Long-Term	C5	- Construct a raised median along US 730 with left-turn lanes at Fox Lane and Moorlando Lane.	- If segment crash rate consistently exceeds the statewide average for similar highway segments.	STIP
	C6	- Acquire right-of-way and construct a westbound u-turn lane/jughandle at Fox Lane.		
	C7	- Acquire right-of-way and construct an eastbound u-turn lane/jughandle at Southshore Drive.		

Note: Potential Funding Sources Include the Following:
 STIP – Statewide Transportation Improvement Program

Table 17 Segment “D” Transportation Improvement Implementation Plan (Umatilla County)

Segment “D”				
Timeframe	Map Reference Number	Action Item	Implementation Threshold	Potential Funding Sources
Short-Term	D1	- Close illegal (not permitted) US 730 approaches.	- As part of initial STIP project.	STIP
	D2	- Purchase and close existing reservations of access in which the affected property has reasonable alternative access to a public side street or other legal approach.	- As part of initial STIP project.	
	D3	- Widen highway to a full three-lane cross-section from Moorlando Lane/Southshore Drive to west end of the existing three-lane highway section.	- As part of initial or subsequent STIP project.	
	D4	- Extend Southshore Drive to the west and construct a new US 730 access across from Moorlando Lane.	- As part of initial or subsequent STIP project.	
	D5	- Purchase access control.	- As part of initial or subsequent STIP project.	
Mid/Long-Term	D6	- Construct a raised median along US 730 with a westbound left-turn lane at Moorlando Lane.	- If segment crash rate consistently exceeds the statewide average for similar highway segments.	STIP
	D7	- Acquire right-of-way and construct a westbound u-turn lane/jughandle at Moorlando Lane.		

Note: Potential Funding Sources Include the Following:
 STIP – Statewide Transportation Improvement Program



Table 18 Segment “E” Transportation Improvement Implementation Plan (Umatilla County)

Segment “E”				
Timeframe	Map Reference Number	Action Item	Implementation Threshold	Potential Funding Sources
Short-Term	E1	- Close illegal (not permitted) US 730 approaches.	- As part of initial or subsequent STIP project.	STIP
	E2	- Purchase and close existing reservations of access in which the affected property has reasonable alternative access to a public side street or other legal approach.	- As part of initial or subsequent STIP project.	STIP
	E3	- Widen highway to a full three-lane cross-section from the west end of the existing three-lane highway section to the east end of the existing three-lane highway section.	- As part of initial or subsequent STIP project.	
	E4	- Purchase access control.	- As part of initial or subsequent STIP project.	
Mid/Long-Term	E5	- Construct a raised median along US 730 with a westbound and eastbound left-turn lane at Southshore Drive.	- If segment crash rate consistently exceeds the statewide average for similar highway segments.	STIP
	E6	- Acquire right-of-way and construct a westbound and eastbound u-turn lane/jughandle at Oxbow Lane and Southshore Drive.		

Note: Potential Funding Sources Include the Following:
 STIP – Statewide Transportation Improvement Program



Table 19 Segment "F" Transportation Improvement Implementation Plan (Umatilla County)

Segment "F"				
Timeframe	Map Reference Number	Action Item	Implementation Threshold	Potential Funding Sources
Short Term	F1	- Close illegal (not permitted) US 730 approaches.	- As part of initial or subsequent STIP project.	STIP
	F2	- Purchase and close existing reservations of access in which the affected property has reasonable alternative access to a public side street or other legal approach.	- As part of initial or subsequent STIP project.	STIP
	F3	- Widen highway to a full three-lane cross-section from the east end of the existing three-lane highway section to the east end of the study corridor.	- As part of initial or subsequent STIP project.	
	F4	- Purchase access control.	- As part of initial or subsequent STIP project.	
Mid/Long Term	F5	- Construct a raised median along US 730 with an eastbound left-turn lane at the east end u-turn lane/jughandle.	- If segment crash rate exceeds the statewide average for similar highway segments.	STIP
	F6	- Acquire right-of-way and construct an eastbound u-turn lane/jughandle at the east end of the study corridor.		

Note: Potential Funding Sources Include the Following:
 STIP – Statewide Transportation Improvement Program



Project Timing and Implementation

With respect to the project priority, each project has been categorized according to whether or not it would occur in the near-term, mid-term, or long-term. Although an attempt has been made to categorize the projects, the actual timing will be primarily dependent upon the availability of funding and redevelopment of private property.

As noted in Tables 14-19, an implementation threshold has been identified for each project. The highway approach closure/consolidation projects identified along the study corridor have all been identified as near-term projects that can likely be implemented as part of the upcoming STIP funding identified by ODOT. Specific details of the approach closure/consolidation projects can be found in the following Access Management section of this plan. As will be identified in this section, there are 28 different highway approaches that can potentially be eliminated from the study corridor, thereby reducing the likelihood of rear-end and turning movement collisions at these driveway locations. Each identified driveway closure/consolidation is a relatively low cost effort, is likely to have little social impacts on the properties that they serve, and they can result in significant safety benefits to the highway.

Although the driveway closure/consolidation projects can be implemented fairly quickly and at a relatively low cost, the remaining projects all involve significant infrastructure improvements that can be more costly and time consuming to implement. Provided sufficient funding is available through the upcoming STIP project, the plan identifies a near-term widening for US 730 to a standard three-lane highway for Segments “C” through “F”. This widening will provide a center left-turn lane that will better facilitate left-turn movements and decrease the potential for certain turning movement and rear-end collisions. A graphical representation of the initial near-term plan and cross section is provided in Figure 23. Recognizing that three lane highway segments have limited long-term safety benefits, the plan has identified an implementation threshold that would ultimately provide for the highway widening to be coupled with a series of raised medians, frontage roads, and jughandle/u-turn lanes. The implementation threshold involves a review of the highway segment crash rates. If it is found that the segment crash rates continue to exceed that statewide average for similar highway facilities, ODOT will then have the ability to implement the higher order access control improvements. A graphical representation of the ultimate long-term highway improvement is illustrated in Figure 24.

TYPICAL THREE LANE CROSS SECTION

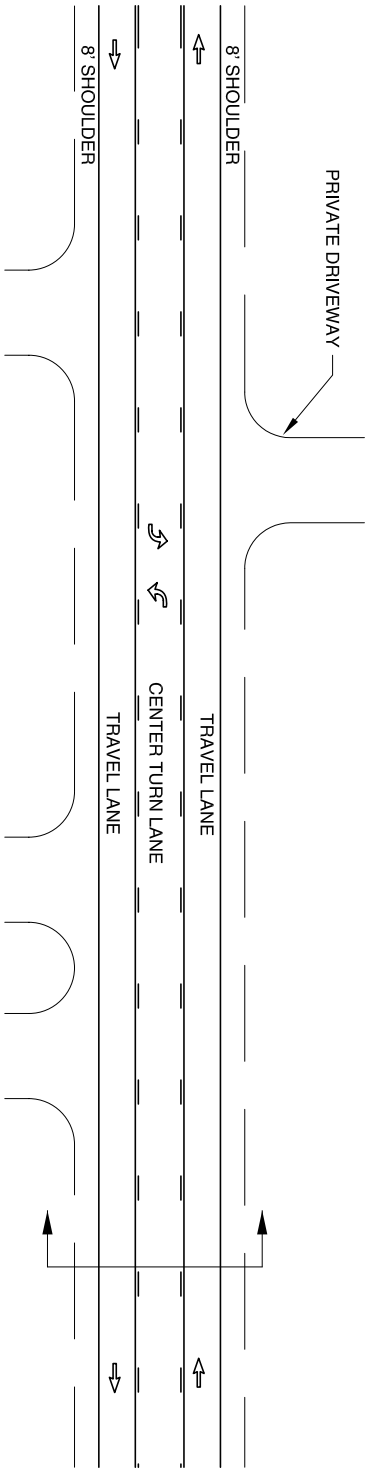
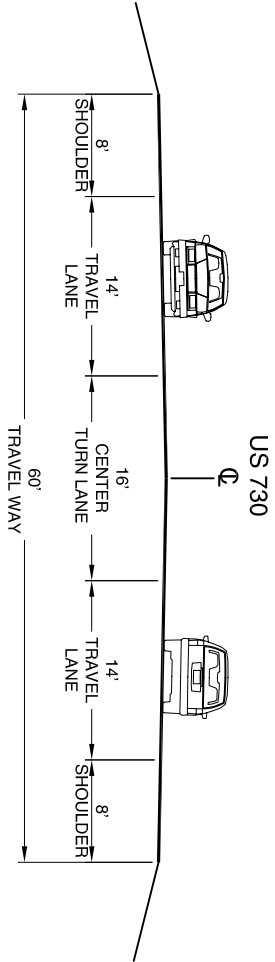

(NOT TO SCALE)

NEAR TERM US 730 PLAN AND CROSS SECTION

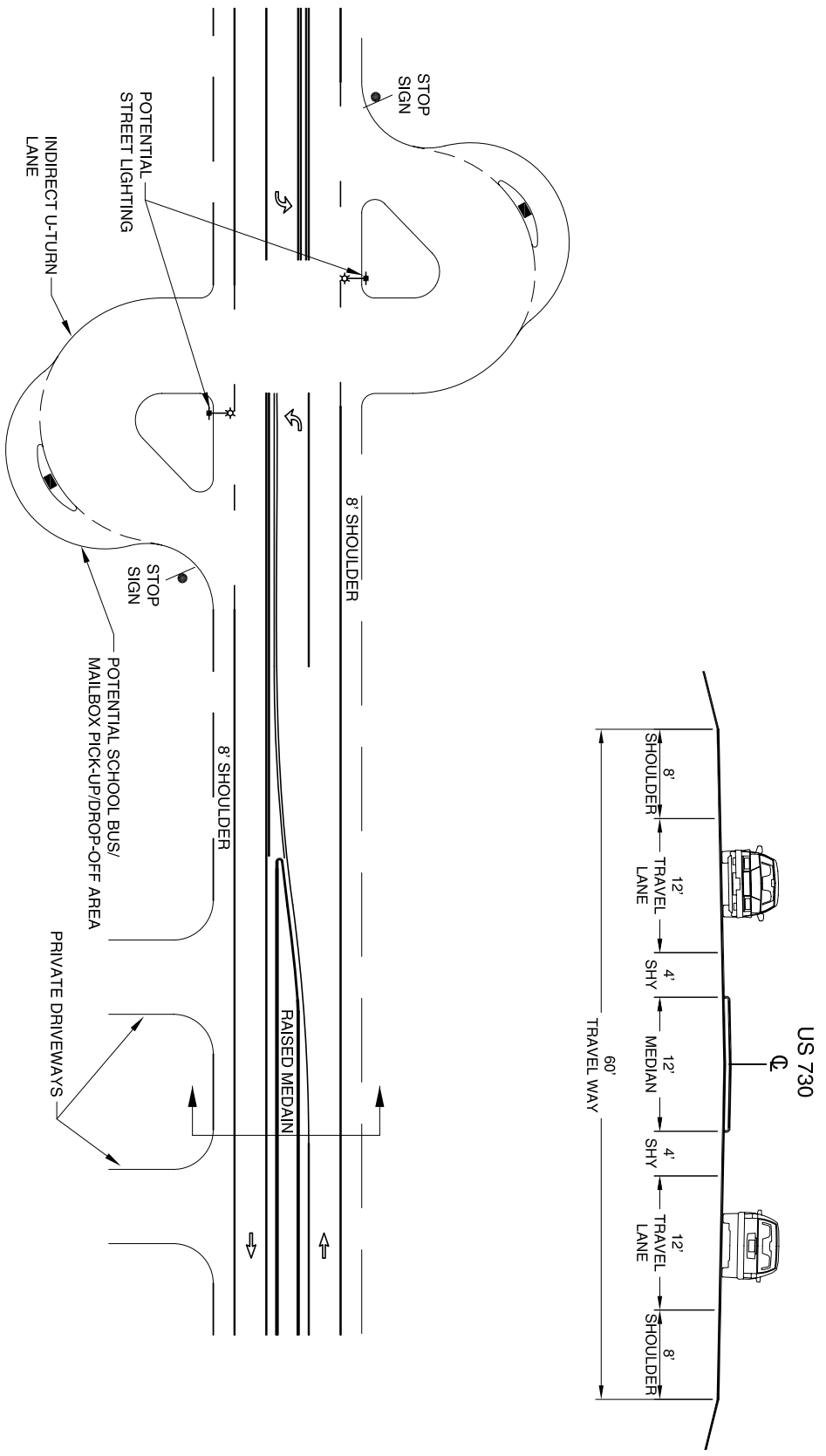

(NOT TO SCALE)

LONG TERM US 730 PLAN AND CROSS SECTION

ACCESS MANAGEMENT PLAN

US 730 between Irrigon and Umatilla currently has a significant number of driveway approaches serving individual farms, homes, and businesses as documented in the Existing Conditions section of this plan. A projected increase in travel demand along US 730 coupled with the turning movement conflicts associated with these driveways is a contributing factor in the safety issues along the study corridor. In order to more effectively manage this condition, it is important to develop a plan for managing existing and future access along the US 730 study corridor.

As part of the US 730 Corridor Refinement Plan, a generalized highway access plan was developed to help identify future access locations and public circulation routes along the study corridor. The plan shall be used by Morrow County, Umatilla County, the City of Umatilla, and ODOT in future land use decisions involving the properties located within and along the US 730 study corridor.

US 730 Access Plan

Access spacing standards along US 730 are currently regulated by the *1999 Oregon Highway Plan*. Although it is inherently difficult to modify existing roadway sections to meet these exact access management standards, under the guidance of the planning process, an access management plan has been developed for the US 730 study corridor. The resulting access management plan contains strategies and future access plans that balance the need to provide reasonable access to the highway while still efficiently accommodating through traffic. Together with the recommended circulation improvement projects, the access management plan will enhance the safety, function, and capacity of the US 730 study corridor. The following sections outline details of the access management plan for US 730.

US 730 from 15th Street to Pleasant View Road (Morrow County)

This section of the study corridor is entirely within Morrow County and is consistent with Segment “A” in Figure 20. Compared with the other sections of the study corridor, there are several unique characteristics of this section that can be used to help shape its long-term access characteristics. First, along the south side of the highway, ODOT has established access control and all of the existing highway approaches currently have reservations of access. Second, there are several platted/planned roadway corridors that have the potential to establish a supporting local roadway network. Given these conditions, the focus of the access management plan on this section of the study corridor is to consolidate the overall number of private access driveways in the near-term and work towards reliance upon the platted/planned public corridors for private access in the long-term. To achieve this, the following access plan and management strategies have been developed:

- Near-Term: Work to close/consolidate the existing highway approach permits and reservations of access through the implementation of the following strategies:
 - Identify illegal approaches and close (those driveways constructed since 1949 without a permit from ODOT) or if appropriate, place under



permit. For legal approach permits, condition the permit to state that private access will be eliminated when other alternate, reasonable access becomes available to the property.

- Identify locations where adjacent properties can share access to US 730 and relocate (indenture) existing highway approaches to the new shared locations.
- Where properties have multiple highway approaches, identify situations where approaches can be consolidated.
- Where properties already have alternate, reasonable access by some means other than US 730 such as an adjacent County roadway, purchase remaining rights of access to the highway and close the driveway(s).
- Purchase access control along those portions of the corridor where it hasn't already been acquired and where future development potential exists.

Based on these strategies, Table 20 summarizes a near-term implementation plan for closing, consolidating, and indenturing the existing highway approaches along this section of US 730¹. Since the majority of approaches have existing reservations of access, closing them will require that ODOT purchase the right of access from property owner. Referencing figures and detailed information for each individual highway approach are provided in Appendix "C".

¹ It should be noted that the access plan outlined in Table 20 will be reviewed in greater detail and possibly refined during any subsequent implementation projects.

Table 20 Near-Term Access Management Implementation Plan (15th Street to Pleasant View Road)

ID #	Side of US 730	M.P.	Type of Access	Serves Tax Lot #	Action	Justification	Potential Impact to Property
2 (Sheet C-1)	South	100.8	Field Access	5N2720 (#100)	Acquire access reservation.	Property served lies within Army Corps Reservation Taking Line. No physical driveway.	Appears to have no significant property impacts.
3 (Sheet C-1)	South	102	Field Access	5N2720 (#100)	Acquire access reservation.	Property served lies within Army Corps Reservation Taking Line. No physical driveway.	Appears to have no significant property impacts.
4 (Sheet C-1)	South	105.3	Field Access	5N2720 (#100)	Acquire access reservation.	Property served lies within Army Corps Reservation Taking Line. No physical driveway.	Appears to have no significant property impacts.
6 (Sheet C-1)	South	106.9	Field Access	5N2720 (#100)	Acquire access reservation.	Property served lies within Army Corps Reservation Taking Line. No physical driveway.	Appears to have no significant property impacts.
7 (Sheet C-2)	South	115	Field Access	5N2720 (#100)	Acquire access reservation.	Property served lies within Army Corps Reservation Taking Line. No physical driveway.	Appears to have no significant property impacts.
8 (Sheet C-2)	South	119.5	Field Access	5N2720 (#100)	Acquire access reservation.	Property served lies within Army Corps Reservation Taking Line. No physical driveway.	Appears to have no significant property impacts.
9 (Sheet C-2)	South	123	Field Access	5N2720 (#100)	Acquire access reservation.	Property served lies within Army Corps Reservation Taking Line. No physical driveway.	Appears to have no significant property impacts.
10 (Sheet C-2)	South	127	Field Access	5N2720 (#100)	Indenture access reservation from private use to public use (future 18 th Street corridor).	Property currently served lies within Army Corps Reservation Taking Line. Future location of 18 th Street corridor intersection with US 730.	Appears to have no significant property impacts.
11 (Sheet C-2)	South	130	Field Access	5N2720 (#2500)	Acquire access reservation and close field access to US 730.	Property has alternative access to US 730 via access #12.	Appears to have no significant property impacts.



ID #	Side of US 730	M.P.	Type of Access	Serves Tax Lot #	Action	Justification	Potential Impact to Property
20 (Sheet C-3)	South	162.3	Field Access	5N2721B (#300)	Acquire access reservation and close field access to US 730.	Property has alternative access to US 730 via access #19.	Appears to have no significant property impacts.
22 (Sheet C-3)	South	166.5	Field Access	5N2721A (#4600)	Acquire access reservation and close field access to US 730.	Property has alternative access to US 730 via Rand Road.	Appears to have no significant property impacts.
23 (Sheet C-3)	South	169	Field Access	5N2721A (#4600)	Acquire access reservation and close field access to US 730.	Property has alternative access to US 730 via Rand Road.	Appears to have no significant property impacts.
26 (Sheet C-4)	South	181	Field Access	5N2721A (#4900)	Acquire access reservation.	Property has alternative access to US 730 via Rand Road.	Appears to have no significant property impacts.
27 (Sheet C-4)	South	184.2	Field Access	5N2721A (#5800)	Acquire access reservation.	Property has alternative access to US 730 via access #29.	Appears to have no significant property impacts.
28 (Sheet C-4)	South	185.7	Field Access	5N2721A (#5800)	Acquire access reservation.	Property has alternative access to US 730 via access #29.	Appears to have no significant property impacts.



- Mid/Long-Term: Establish public access to the south side of US 730 as outlined below.
 - As part of private property redevelopment or capital improvement projects, establish a public access reservation (through a Grant of Access) and approach at the future 18th Street corridor. This full access connection would provide both near-term and long-term access to/from US 730. It should be noted that some property will need to be acquired from the US Army Corps of Engineers in order to establish a public roadway connection to US 730.
 - As part of private property redevelopment, establish a public access reservation (through a Grant of Access) at the future 19th Street corridor. In the near-term, the 19th Street corridor would be full access to/from US 730. When supporting parallel roadway facilities (Oregon Street and Bevington Lane) are established, this access could potentially revert to a limited access right-in/right-out intersection if segment crash rates along US 730 exceed statewide rates for similar highway facilities.
 - As part of redevelopment, establish a public access reservation (through a Grant of Access) at the future 21st Street corridor. This full access connection would provide both near- and long-term access to/from US 730.
 - In the near-term, the existing Rand Road access would be full access to/from US 730. When supporting parallel roadway facilities (Oregon Street and Bevington Lane) are established, this access could potentially revert to a limited access right-in/right-out intersection if segment crash rates exceed statewide rates for similar highway facilities.
 - Upon redevelopment, redirect property access to the local roadway system, purchase remaining access reservations, and close highway approaches.
- Mid/Long-Term: Establish public access to the north side of US 730 opposite Rand Road.
 - As part of private property redevelopment, establish a public access approach to the north side of US 730 across from Rand Road. When supporting parallel roadways are established that provide backage road access to Pleasant View Road, this access could potentially revert to a limited access right-in/right-out intersection if segment crash rates along US 730 exceed statewide rates for similar highway facilities.
 - Upon redevelopment, redirect property access to the local roadway system and close existing highway approaches.
- Mid/Long-Term: Construct raised medians along US 730 between the future 18th Street corridor and Pleasant View Road with full access median breaks at the future 18th Street, future 21st Street, and existing Pleasant View Road corridors. The construction of medians should not be considered until parallel roadway facilities are in place, alternate access has been established for properties impacted by the median, and noted safety performance measures have been met.



*US 730 from Pleasant View Road to East End of the Study Corridor
(Umatilla County)*

This section of the study corridor is entirely within Umatilla County and is consistent with Segments “B” through “F” in Figures 21-22. Compared with the Morrow County section, there are significantly more highway approaches and less potential for the development of a supporting local roadway network. Given these conditions, the focus of the access management plan on this section of the study corridor is to consolidate the overall number of private access driveways in the near-term and plan to limit access and turning movements in the long-term through frontage roads and highway median controls. To achieve this, the following access plan and management strategies have been developed:

- Work to consolidate the existing highway approach permits and reservations of access through the implementation of the following strategies:
 - Identify illegal approaches and close (those driveways constructed since 1949 without a permit from ODOT) or if appropriate, place under permit. For legal approach permits, condition the permit to state that private access will be eliminated when other alternate, reasonable access becomes available to the property.
 - Identify locations where adjacent properties can share access to US 730 and relocate (indenture) existing highway approaches to the new shared locations.
 - Where properties have multiple highway approaches, identify situations where approaches can be consolidated.
 - Where properties already have alternate, reasonable access by some means other than US 730 such as an adjacent County roadway, purchase remaining rights of access to the highway and close the driveway(s).
 - Purchase access control along those portions of the corridor where it hasn't already been acquired and where future development potential exists.

Based on these strategies, Table 21 summarizes a near-term implementation plan for closing, consolidating, and indenturing the existing highway approaches along this section of US 730². Referencing figures and detailed information for each individual highway approach are provided in Appendix “C”.

² It should be noted that the access plan outlined in Table 21 will be reviewed in greater detail and possibly refined during any subsequent implementation projects.

Table 21 Near-Term Access Management Implementation Plan (Pleasant View Road to East End of Study Corridor)

ID #	Side of US 730	M.P.	Type of Access	Serves Tax Lot #	Action	Justification	Potential Impact to Property
36 (Sheet C-5)	South	213.56	Field Access	5N2722 (#400)	Close driveway.	Property has alternative access to US 730 via access #37.	Appears to have no significant property impacts.
42 (Sheet C-6)	South	255.27	Field Access	5N2714C (#600)	Close driveway.	Property has alternative access to US 730 via access #43.	Appears to have no significant property impacts.
45 (Sheet C-7)	South	264.25	Field Access	5N2714C (#800)	Close driveway.	Property has alternative access to US 730 via Fox Lane.	Appears to have no significant property impacts.
46 (Sheet C-7)	South	266.36	Residence	5N2714C (#800)	Close driveway.	Property has alternative access to US 730 via Fox Lane.	Would likely require new access road to Fox Lane.
55 (Sheet C-8)	South	289.59	Field Access	5N2714D (#1300)	Close driveway.	Property has alternative access to US 730 via access #56.	Appears to have no significant property impacts.
69 (Sheet C-9)	South	321.27	Field Access	5N2713C (#3200)	Acquire access reservation and close field access to US 730.	Property has alternative access to US 730 via access #70.	Appears to have no significant property impacts.
72 (Sheet C-9)	South	329.19	Field Access	5N2713D (#1800)	Acquire access reservation and close field access to US 730.	Property has alternative access to US 730 via access #73.	Appears to have no significant property impacts.
91 (Sheet C-11)	South	377.24	Field Access	5N2818 (#1508)	Close driveway.	Property has alternative access to US 730 via access #92	Appears to have no significant property impacts.
98 (Sheet C-11)	South	387.80	Field Access	5N2818DB (#2300)	Acquire access reservation and close field access to US 730.	Property has alternative access to US 730 via access #97.	Appears to have no significant property impacts.
100 (Sheet C-11)	South	389.91	Field Access	5N2818DB (#300)	Acquire access reservation and close field access to US 730.	Property has alternative access to US 730 via Powerline Road.	Appears to have no significant property impacts.
101 (Sheet C-12)	South	394.13	Field Access	5N2818DB (#300)	Acquire access reservation and close field access.	Property has alternative access to US 730 via Powerline Road.	Appears to have no significant property impacts.
105 (Sheet C-11)	North	395.72	Field Access	5N2818 (#200)	Acquire access reservation and close field access.	Property has alternative access to US 730 via access #104.	Appears to have no significant property impacts.
108 (Sheet C-11)	North	394.13	Business	5N2818 (#400)	Acquire access reservation and close access.	Property has alternative access to US 730 via access #109.	Appears to have no significant property impacts.



- Mid/Long-Term: Establish a frontage road on the south side of US 730 between Pleasant View Road and Fox Lane.
 - Frontage roads will be considered if segment crash rates along that US 730 exceed statewide rates for similar highway facilities.
 - Close individual property driveways and reconnect them to the frontage road.
- Mid/Long-Term: Construct raised medians along US 730 between Fox Lane and the east end of the study corridor.
 - Full access median breaks would be provided at Fox Lane, Moorlando Lane/South Shore Drive (west), Oxbow Lane/South Shore Drive (east), and a new north side access at the east end of the study corridor.
 - The construction of medians should not be considered until segment crash rates along that section of US 730 exceed the statewide rates for similar highway facilities.
 - Construct jughandle/u-turn lanes at the median breaks to better facilitate private property access that is restricted by the raised medians.
- All remaining highway approaches would continue to have median restricted limited access to US 730.

Local Access Management Standards

As part of their existing Transportation System Plan, Morrow County, Umatilla County, and the City of Umatilla have all adopted an access management plan for their applicable roadways/streets. These standards are outlined in the respective Transportation System Plans (TSP) and are all consistent with the identified projects listed in the US 730 Access Management Plan. In addition to the local access management standards, each of the TSPs have adopted the ODOT access management standards outlined in the *1999 Oregon Highway Plan* (subsequently reproduced in Appendix “E” of this document) for private property access to state facilities. It should be noted that the City of Umatilla TSP was developed prior to completion of the *1999 Oregon Highway Plan*. As such, the access spacing standard references are no longer valid. For consistency purposes, it is recommended that the City of Umatilla modify the references to the current standards outlined in the *1999 Oregon Highway Plan*.

TRANSPORTATION FUNDING PLAN

Typically funding for transportation improvement projects are derived from state and local funding sources. The following paragraphs provide a general overview of these sources. As funding for projects becomes available, the list of transportation improvement projects identified in the refinement plan should be used to select projects for implementation.

State Funding

ODOT operates and maintains US 730 within the study corridor. State and Federal funds administered through ODOT will be the primary sources of funding for improvements to this facility. All highway related improvement projects are funded through the Statewide Transportation Improvement Program (STIP). As described in Section 2, ODOT currently has an upcoming STIP project set aside for US 730. This STIP project has identified funding for the purposes of addressing the safety issues along US 730. With the help of this plan, the funding will be used to implement specific projects for the study corridor. In the near-term, this funding should be used to perform some of the highway approach closure/consolidation projects identified throughout the study corridor. In addition, some of the highway widening projects (three-lane cross-section and shoulder widening) are also recommended in the near-term for segments located in the eastern third of the study corridor. Given the length of the corridor, other projects such as the frontage road segment and construction of raised medians will most likely need to be funded through future STIP projects as warranted.

Local Funding

Many of the circulation projects identified in the western third of the study corridor (Morrow County) involve the planning and development of parallel and supporting local roadways to support existing and future development. Given the high level of annual expenditures needed for construction of the transportation projects identified, existing sources of revenue are not expected to be adequate to meet the demand for new projects. To meet the additional funding needs, Morrow County may wish to consider additional revenue-generating options such as systems development charges and local transportation improvement districts to supplement existing general fund revenues. Projects such as the 18th Street, 19th Street, 21st Street, and Bevington Lane corridors would benefit from these funding sources.

It should be noted that, even with increased funding, it may prove difficult to fund all of the projects identified in this plan. Accordingly, Morrow County and ODOT should review the identified improvement projects on a periodic basis to prioritize local transportation system funding such that it most appropriately reflects current and projected needs.



US 730 CORRIDOR REFINEMENT PLAN IMPLEMENTATION

To implement the recommendations of the US 730 Corridor Refinement Plan, the contents of this plan will need to undergo an extensive review and adoption process at the local (City of Umatilla, Morrow County, and Umatilla County) and state (ODOT and Oregon Transportation Commission) levels. These steps are outlined below.

Preparation of Morrow County, Umatilla County, and City of Umatilla TSP Amendments

All three jurisdictions will need to either amend their TSPs per the applicable elements of the US 730 Corridor Refinement Plan and/or adopt the plan by reference.

DLCD Review

As requires by OAR 660-018, the amendment documents will need to be submitted to the Department of Land Conservation and Development (DLCD) for review at least 45 days prior to the first evidentiary public hearing.

Morrow County

The Morrow County Planning Commission and County Court will need to hold separate public hearings to review and formally adopt the applicable contents of the Morrow County TSP.

Umatilla County

The Umatilla County Planning Commission and Board of Commissioners will need to hold separate public hearings to review and formally adopt the applicable contents of the Morrow County TSP.

City of Umatilla

The City of Umatilla Planning Commission and City Council will need to hold separate public hearings to review and formally adopt the applicable contents of the Morrow County TSP.

Oregon Transportation Commission

Following local adoption of the contents of the US 730 Corridor Refinement Plan, the Oregon Transportation Commission (OTC) will need to formally adopt the plan.

I-82/US 730 IAMP

Umatilla, Oregon

Prepared by:

Kittelson & Associates, Inc.

In association with:

Angelo Planning Group

Anderson Perry & Associates, Inc.



I-82/US 730 Interchange Area Management Plan

Umatilla, Oregon

September 2011

I-82/US 730 Interchange Area Management Plan

Umatilla, Oregon

Prepared For:

Oregon Department of Transportation

Region 5

3012 Island Avenue

La Grande, OR 97850

(541) 963-3177

Prepared By:

Kittelson & Associates, Inc.

610 SW Alder, Suite 700

Portland, OR 97205

(503) 228-5230

Project Analyst: Nick Foster

Project Manager: Matt Hughart, AICP

Project Principal: Marc Butorac, PE, PTOE

Project No. 10369.00

September 2011



Table of Contents

Section 1	Introduction.....	2
Section 2	Interagency and Public Involvement Program	10
Section 3	Plan and Policy Review	16
Section 4	Inventory of Existing Transportation/Land Use Conditions	19
Section 5	2030 Future Conditions	52
Section 6	Concept Development and Analysis	64
Section 7	Interchange Area Management Plan.....	95
Section 8	Implementation Plan.....	112
Section 9	OAR and OHP Compliance.....	121
Section 10	References	128

List of Figures

Figure 1-1	Interchange Management Study Area	4
Figure 4-1	Study Area Vicinity Map.....	20
Figure 4-2	Interchange Management Study Area	21
Figure 4-3	Study Area Zoning.....	23
Figure 4-4	Existing Lane Configurations & Traffic Control Devices.....	30
Figure 4-5	Existing Traffic Conditions, 30 th Highest Hour	39
Figure 4-6	Access Inventory, West of I-82 and I-82 Ramps	47
Figure 4-7	Access Inventory, East of I-82	48
Figure 5-1	Land Use Sub-Areas.....	53
Figure 5-2	Study Area Zoning.....	54
Figure 5-3	Year 2030 Traffic Conditions, 30 th Highest Hour.....	61
Figure 6-1	Concept 3 (Original)	75
Figure 6-2	Concept 3 (w/ Potential POE Relocation).....	76
Figure 6-3	Concept 8b	77
Figure 6-4	Concept 8c	78
Figure 6-5	Concept 8d	79
Figure 6-6	Concept 8e	80
Figure 6-7	Concept 9.....	81
Figure 6-8	Concept 11	82
Figure 6-9	Concept 13, I-82/US 730 Interchange Area	83
Figure 6-10	Concept 13, Relocated POE and Necessary Accessory Weighing Facilities.....	84
Figure 6-11	Year 2030 Concept 13 Operations, 30 th Highest Hour Volumes - Existing POE Site Vacant 89	
Figure 6-12	Year 2030 Concept 13 Operations, 30 th Highest Hour – Existing POE Site Redeveloped 92	
Figure 7-1	Transportation Improvement Plan, I-82/US 730 Interchange Area	96
Figure 7-2	IAMP Transportation Improvement Plan, Relocated POE and Necessary Accessory Weighing Facilities	97

Figure 7-3	Transportation Improvement Plan Lane Configurations and Traffic Control Devices, I-82/US 730 Interchange Area	98
Figure 7-4	Relocated POE, Conceptual Drawing.....	101
Figure 7-5	Typical Truck Scale, Conceptual Drawing	102
Figure 7-6	Access Management Plan.....	106

List of Tables

Table 2-1	Technical Advisory Committee.....	11
Table 2-2	Public Advisory Committee	11
Table 2-3	Meeting Summary	13
Table 4-1	Existing Transportation Facilities and Roadway Designations	31
Table 4-2	Intersection Crash Histories (January 1, 2004 through December 31, 2008)	42
Table 4-3	Roadway Segment Crash Histories (January 1, 2004 through December 31, 2008)	43
Table 4-4	Existing Public/Private Access Approach Inventory	45
Table 5-1	Future Conditions Sub-Area Analysis Zones	57
Table 5-2	I-82 / US 730 Development Assumptions	58
Table 5-3	Background Growth Rate Calculations on US 730.....	59
Table 5-4	Background Growth Rate Calculations on I-82.....	60
Table 5-5	Forecast Deficiencies.....	62
Table 6-1	Summary of Qualitative Screening Process	73
Table 6-2	Preliminary Cost Estimates	87
Table 6-3	Concept Development and Screening Summary.....	88
Table 6-4	Operational Analysis Comparison.....	90
Table 6-5	POE Site Redevelopment and Trip Generation Potential	91
Table 7-1	IAMP Transportation Improvements	99
Table 9-1	OAR 734-051 Issues Addressed.....	121

List of Exhibits

Exhibit 4-1	Intersection Spacing Near I-82 SB Ramp Terminals	32
Exhibit 4-2	Daily Traffic Volume Profile for I-82 Southbound Ramps at US 730	36
Exhibit 4-3	Daily Traffic Volume Profile for I-82 Northbound Ramps at US 730	36
Exhibit 4-4	Daily Traffic Volume Profile for I-82 North of US 730.....	37
Exhibit 4-5	Daily Traffic Volume Profile on US 730 East of I-82	37
Exhibit 4-6	Daily Traffic Volume Profile on US 730 West of I-82	38
Exhibit 4-7	Trucks Exiting the Port of Entry to Return to I-82 Southbound	40

Technical Appendix, Volume 2 (Under Separate Cover)

Appendix A	Meetings Summaries
Appendix B	Technical Memorandum #1 – Definition and Background
Appendix C	Technical Memorandum #2 – Review of Adopted Plans and Regulations
Appendix D	Technical Memorandum #3/4 – Existing Land Use and Transportation Conditions
Appendix E	Technical Memorandum #5 – Environmental Technical Memorandum
Appendix F	Technical Memorandum #6 – Future Land Use and Transportation Conditions
Appendix G	Technical Memorandum #7a – Preliminary Concept Development & Analysis
Appendix H	Technical Memorandum #7b – Detailed Concept Analysis
Appendix I	Technical Memorandum #7c – Additional Concept Analysis
Appendix J	Technical Memorandum #7d – Relocated Port of Entry Analysis
Appendix K	Proposed Local Ordinance Amendments

DISCLAIMER

The inclusion of proposed projects and actions in this plan does not obligate or imply obligations of funds by any jurisdiction for project level planning or construction. The inclusion of proposed projects and actions does serve as an opportunity for projects to be included, if appropriate in the State Transportation Improvement Program (STIP) and the City of Umatilla Capital Improvements Program (CIP) but such inclusion is not automatic. It is incumbent on the state, county, city and general public to take action to encourage and support inclusion into the STIP or CIP at the appropriate time. Because a project must have actual identified funding to be included in the STIP or CIP, the ultimate number of projects included in these documents is constrained by available funding.

Preface

The development of this plan was guided by the Project Management Team (PMT) Steering Committee (SC), Technical Advisory Committee (TAC), and Public Advisory Committee (PAC). The members these groups are identified below, along with members of the consultant team. The PMT and SC members were all part of the TAC and PAC. The SC included representation from ODOT, the City of Umatilla, and the Umatilla Port of Entry. The TAC and PAC members were responsible for reviewing all work products and guiding the planning work. They devoted a substantial amount of time and effort to the development of the I-82/US 730 Interchange Area Management Plan (IAMP), and their participation was instrumental in the development of the recommendations that are presented in this plan.

Project Management Team (PMT)

Teresa Penninger*
ODOT Region 5 Planning

JR Cook/Bob Ward*
City of Umatilla

Technical Advisory Committee (TAC)

Bill Meade
Umatilla City Council

Cindy Roxbury
Umatilla City Council

Darla Huxel*
City of Umatilla Police Department

Dave Warrick
ODOT Interchange Engineer

Donald Fine*
ODOT Region 5 Traffic

Grant Young
Oregon DLCD

Zach Lunden
City of Umatilla

Ken Patterson*
ODOT District 12

Mike Roxbury
Umatilla Rural Fire District

Randall Thomas
ODOT Statewide Mobility Manager

Rich Lani
ODOT District 12

Roger Frances*
City of Umatilla

Swede Hays
ODOT Rail

Tamra Mabbot
Umatilla County

Tom Kuhlman*
ODOT Region 5 Traffic

*Steering Committee Member

Public Advisory Committee (PAC)

Al Koppany
Crossroads Truck Stop

Ben Derby*
Umatilla Port of Entry

Bob Martinez
Two Rivers Correctional Institute

Heidi Sipe
Umatilla Planning Commission

Karen Hutchinson-Talaski
Umatilla Chamber of Commerce

Lyle Smith
Umatilla Planning Commission

Sam Nobles
UGA Land Owner

Steve Johnson
Umatilla City Council

*Steering Committee Member

Consultant Team

Kittelson & Associates, Inc.
Matt Hughart, AICP - *Project Manager*
Nick Foster - *Project Analyst*
Marc Butorac, PE, PTOE - *Project Principal*

Anderson-Perry & Associates, Inc.
Jeremy Morris, PE
Shelly Schmidt

Angelo Planning Group, Inc.
Shayna Rehberg, AICP
Darci Rudzinski, AICP

Section 1
Introduction

Introduction

An Interchange Area Management Plan (IAMP) has been prepared for the Interstate-82 (I-82) / US 730 Interchange in Umatilla, Oregon. The following section provides an overview of the purpose and intent of the IAMP and defines: the interchange function, the project goals and objectives, and the study area. These elements have been defined through a collaborative effort between the project Technical Advisory Committee (TAC) and Public Advisory Committee (PAC).



PURPOSE AND INTENT

The IAMP is a strategic transportation plan that is designed to protect the long-term function of the Interstate 82 (I-82) / US 730 interchange by preserving the capacity of the interchange while providing safe and efficient operations between connecting roadways. The IAMP will identify land use management strategies, short-term and long-term transportation improvements, access management goals, and strategies to fund identified improvements.

The intent is that the IAMP planning efforts will result in policies, ordinances, and other provisions that will be adopted into the City of Umatilla and Umatilla County's Transportation System Plan (TSP) and Comprehensive Plan. The IAMP will also be adopted by the Oregon Transportation Commission (OTC) as an amendment to the Oregon Highway Plan.

PROBLEM STATEMENT

The signalized intersections of Brownell Boulevard/US 730 and the southbound I-82/US 730 terminal are located within close proximity of one another resulting in undesirable operations. The signals have been coordinated in an effort to improve intersection operations. Nevertheless, queuing problems associated with truck traffic accessing the Umatilla Port of Entry (POE) weigh station continue to occur at the two intersections. This condition varies by season due to increase of trucks during mid-summer and fall harvests.

The Port of Entry and weigh station is located on the northwest corner of Brownell Boulevard/US 730 intersection which coincides with the northwest quadrant of the I-82/US 730 interchange. A truck stop, restaurant, fueling station and other commercial development is located in the southwest quadrant. East of the interchange is primarily vacant land within the City of Umatilla Urban Growth Area. This land is zoned exclusive farm use, tourism commercial or public facilities. The City is interested in the economic development potential of this area and would like to develop a local street network plan that supports the safe and efficient operation of the interchange and the US 730/US 395 intersection located within the interchange influence area.

INTERCHANGE DESCRIPTION

The I-82/US 730 interchange is an urban interchange that connects US 730 and US 395 with I-82. It is the only interchange serving Umatilla. The interchange is also important for interstate freight travel, as it provides access to the Umatilla POE for trucks entering Oregon from Washington and US 395, a designated freight route. US 730, which is also locally known as 6th Street through Umatilla, provides one of two east-west connections between downtown Umatilla and the McNary area of Umatilla, making it a vital connection to the city. Beyond Umatilla, US 730 connects to I-84 southwest of Irrigon and to US 12 in Washington to the east.

The land uses within the immediate vicinity of the interchange are primarily commercial on the west side and vacant on the east side.

Interchange Function Statement

Following is the function and policy definition for the I-82/US 730 Interchange:

“The primary function of the I-82/US 730 interchange is to facilitate statewide and inter-urban and inter-regional travel to/from the I-82 corridor. A secondary function is to provide east-west inter-regional connectivity across I-82 for the City of Umatilla and surrounding rural land uses. I-82 is a short, but significant interstate highway that connects the state of Washington to the I-84 corridor.”



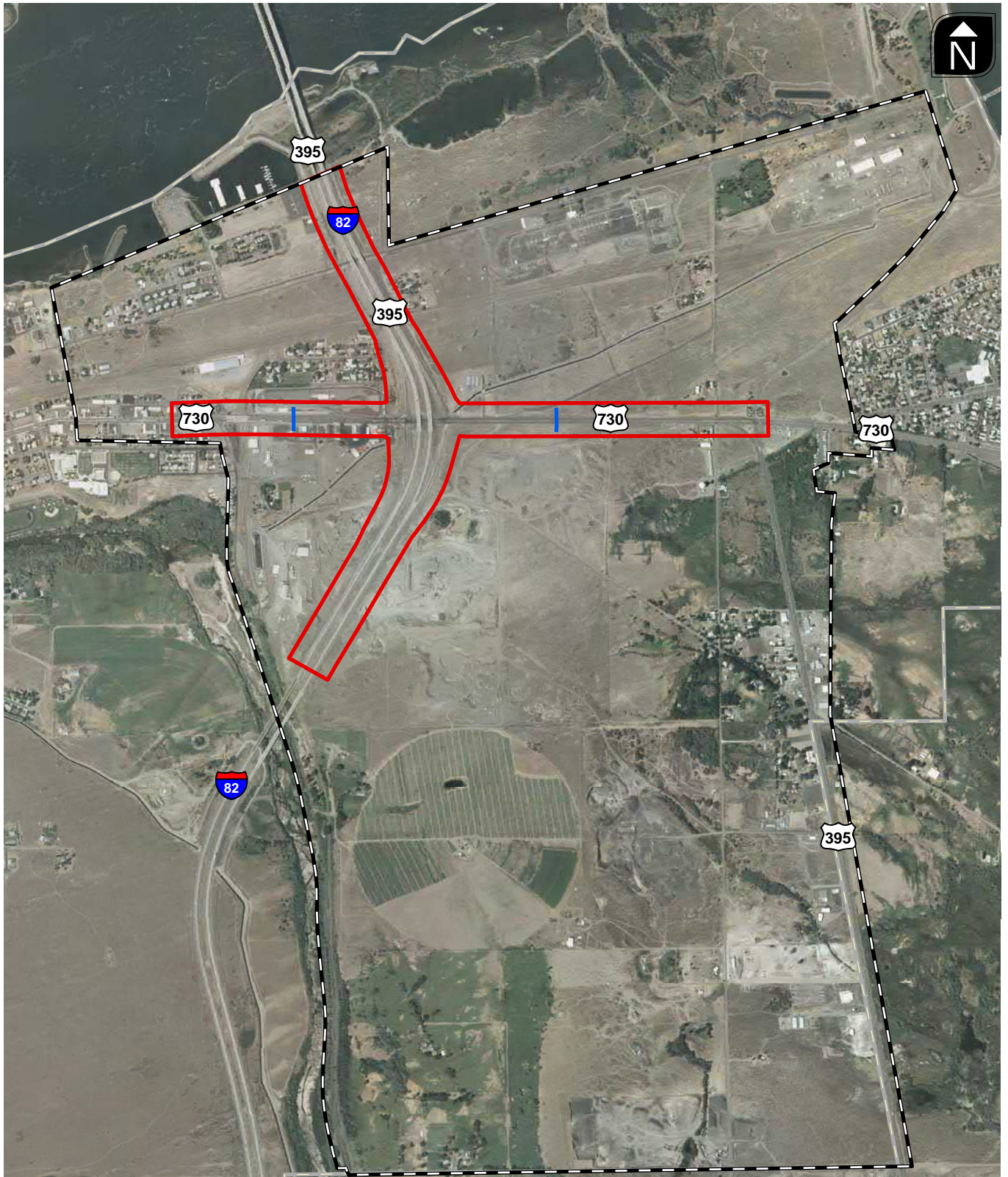

INTERCHANGE MANAGEMENT STUDY AREA

To provide a comprehensive study and to achieve effective results, the Interchange Management Study Area (IMSA) includes developable and re-developable properties and major roadways that would significantly affect the interchange function over the next 20 years. The IMSA includes properties within ½-mile, and in some cases beyond, from the existing I-82 interchange as defined by the IAMP Guidelines. The IMSA also takes into account facilities and properties that will impact the operations of the interchange and any natural or cultural resources in the vicinity of the interchange.

The IMSA map is shown in Figure 1-1. Figure 1-1 identifies key features and boundaries of the area included in the IAMP. As shown on the IMSA map, two study boundaries are identified: the IAMP Operations and Access Study area and the Land Use Study Area. The following describes the criteria used to create the IMSA map.



LEGEND

-  Minimum 1320' IAMP Limits
-  Land Use Study Area
-  Operations/Access Study Area
-  Umatilla UGB

**INTERCHANGE MANAGEMENT STUDY AREA
UMATILLA, OREGON**

**FIGURE
1-1**

H:\projects\110369 - I-82 US 730 IAMP\GIS\UmatillaBaseMap.mxd

Operations and Access Study Area

The Operations and Access Study Area includes all access points and intersections within ¼-mile of the existing I-82/US 730 interchange and encompass key intersections that have potential to affect traffic operations in the interchange area over the planning period. This study boundary identifies the area for which operational analysis will be completed and the area that will be considered in the Access Management Plan element of the IAMP. The study intersections include:

- I-82/US 730 Northbound Terminal
- I-82/US 730 Southbound Terminal
- US 730 / US 395
- US 730 / Lind Road
- US 730 / Scaplehorn Road
- US 730 / Private Driveway (Umatilla Self Storage business) between Scaplehorn Road and Northbound I-82 ramp
- US 730 / Brownell Boulevard
- US 730 / Port or Entry Entrance Driveway
- US 730 / two private business driveways (Crossroads)
- US 730 / Eisele Drive
- US 730 / River Road
- US 395 / Margaret Avenue
- US 395 / Power City Road

Land Use Study Area

The Land Use Study Area includes all properties located roughly within a ½-mile of the interchange. The Land Use Study Area extends beyond a ½-mile in places to incorporate developable and re-developable properties that are expected to significantly affect the interchange function over the next 20 years. Properties identified with potential to affect the interchange include those that are expected to utilize the interchange as their primary connection to I-82 or those that may be necessary to examine to improve local circulation.

GOALS AND OBJECTIVES

The primary goal of the IAMP process is to protect the function of the interchange by anticipating changes in land use and traffic patterns and planning for necessary improvements over a 20-year planning horizon. As stated in Policy 3C of the 1999 Oregon Highway Plan, *“it is the policy of the State of Oregon to plan for and manage grade-separated interchange areas to ensure safe and efficient operation between connecting roadways.”* From this definition, the objectives of the I-82 / US 730 IAMP are to:

- Refine and prioritize improvements needed to maintain acceptable traffic operations at the interchange while providing safe access to adjacent land uses;
- Provide for efficient connectivity, right-of-way, and access control in the Interchange Management Study Area (IMSA);
- Consider the surrounding contextual land use and roadway network;
- Provide plans for improved local street connectivity in the IMSA (see definition below) while limiting cul-de-sacs or other non-connected streets;
- Evaluate existing and potential land use designations, intensities, conditions, and actions that could have favorable effect on the facility or an adverse effect on the facility;
- Collaborate throughout the planning process with design professionals, jurisdictional representatives, developers, and local property owners.
- Comply with the intent of Statewide Planning Goal 1: Public Involvement, 2: Land Use Planning, 5: Natural Resources, 6: Air, Water and Land Resources Quality, 7: Areas Subject to Natural hazards, 8: Recreation Needs, 9: Economic Development, 12: Transportation, and 14: Urban Growth Boundaries.
- Develop policies and implementation measures that support the goals of this project for local consideration and adoption into the City and County comprehensive plans, transportation system plans, and zoning ordinances, as appropriate.

EVALUATION CRITERIA

Based on the above objectives, the following evaluation criteria were assembled to ensure that each concept developed throughout the project would be evaluated for consistency with the overall intent of the community and the project. The six evaluation criteria categories are outlined below:

- **Transportation Operations:** This category consists of those criteria that assess the ability for all modes to travel through and within the study area. Special considerations within this category include safety, local connectivity and mobility, including freight mobility.
- **Land Use:** This category consists of those criteria that assess right-of-way impacts, consistency with adopted land use and economic development plans, transportation capacity impacts of changes in land use intensity, impacts to utilities, and impacts to existing and proposed developments.
- **Economic Development:** This category consists of those criteria that assess the potential for short-term (1-5 years), mid-term (5-15 years), and long-term growth (15-25 years) for areas within the vicinity of the interchange.
- **Cost:** This category consists of those criteria that assess the practicality of a design concept from a construction cost and feasibility perspective.
- **Environmental, Social, and Equity factors:** This category consists of those criteria that assess the degree to which a concept is compatible with the natural and built environment

including environmental (i.e., storm water drainage and hazardous waste) and socio-economic (i.e., stakeholders' needs) impacts.

- **Accessibility:** This category consists of those criteria that assess the ability to access properties and businesses within the IMSA to/from the regional infrastructure network including the balance between local access and roadway function, future access for undeveloped properties, and adherence to the access spacing standards.

DEVELOPMENT OF THE IAMP

The I-82/US 730 IAMP has been guided by the Technical Advisory Committee (TAC) and Public Advisory Committee (PAC), as well as area residents and business owners. TAC and PAC roster lists are provided in the Preface of this document and in Section 2. Regular TAC and PAC meetings held throughout the course of the project have provided opportunities for the two committees to review and guide the technical analysis prepared by the consultant team and the overall project direction. *A summary of the individual TAC and PAC meetings is provided in Appendix "A."*

Public Involvement

In addition to the regular TAC and PAC meetings, local citizens, property owners, and business owners provided their input by participating in three public workshops. The first workshop provided participants with background information on the project and then gave them the opportunity to develop and present their ideas for design concepts. At the second workshop, participants provided their input on the design concepts that had previously been developed. The third workshop was focused on a review of the draft IAMP. Members of the public also submitted comments directly to the project management team either through correspondence or by attending a TAC or PAC meeting. In addition, adoption of the plan will have included public hearings before the City of Umatilla Planning Commission and Council and the Oregon Transportation Commission. *Summaries of the public meetings are provided in Appendix "A."*

IAMP ORGANIZATION AND METHODOLOGY

The development of the I-82/US 730 IAMP began in January 2010 with the first meeting of the consultant team and City and ODOT staff. Work with the TAC and PAC began shortly thereafter in February 2010. Since February 2010, these groups participated in an extensive process that involved reviewing existing and future transportation conditions, future land use analyses, interchange design and local access and circulation concepts, and financing options.

Sections 1 through 9 comprise Volume 1 of the IAMP and provide the main substance of the plan. These are supplemented by Technical Appendices in Volume 2 which contains the technical memoranda documenting each step in the process. The organization and description of each element of the IAMP are outlined below:

Section 1 describes the IAMP process, purpose, and goals and outlines the remainder of the document;

Section 2 details the interagency and public involvement program;

Section 3 provides the plan and policy review;

Section 4 outlines the existing land use patterns and transportation facilities within the IMSA;

Section 5 documents the future land use and transportation conditions and how they were addressed by the planning effort;

Section 6 provides a description of the concepts analysis and transportation planning efforts involving the selection of a preferred interchange form, supporting local access and circulation network, access management plan, and land use management plan;

Section 7 is the I-82/US 730 IAMP, including the local circulation and access elements and the transportation improvement projects that are necessary to ensure the continued long-term safety and function of the interchange;

Section 8 provides guidance on IAMP adoption, monitoring, and updates; and,

Section 9 documents how the I-82/US 730 IAMP complies with the Oregon Administrative Rules for the development of an interchange area management plan as well as the Oregon Highway Plan.

Section 7
Interchange Area
Management Plan

Interchange Area Management Plan

The I-82/US 730 IAMP provides a transportation improvement plan and an Access Management Plan (AMP). The transportation improvement plan includes interchange and local circulation improvements, as well as a phasing schedule. The AMP contains an access management plan and documents the justification for the necessary deviations to ODOT's access management standards.



Through adoption by the City of Umatilla, Umatilla County, and ODOT, future development located within the Interchange Management Study Area (IMSA) will be required to make circulation and access improvements, as identified in this plan. Implementation of the IAMP is expected to preserve the functional integrity of the interchange over time and ensure viable access to existing and future land uses. Finally, the action items contained within the implementation plan (Section 8) will ensure proper coordination between the various stakeholders and that the IAMP remains a dynamic long-term planning tool.

TRANSPORTATION IMPROVEMENT PLAN OVERVIEW

A comprehensive transportation improvement plan including a local circulation and access plan within the interchange management study area (IMSA) was developed based on the concept screening and evaluations outlined in Section 6. Figures 7-1 and 7-2 illustrate the transportation improvement plan. This plan includes the relocation of the Port of Entry (POE) to a new location along I-82, alignments of new roadways and intersections, and modifications to existing roadways and intersections. Each transportation improvement identified in the two figures is described in Table 7-1. Figure 7-3 illustrates the lane configurations and traffic control devices associated with the improvement plan. This table also contains preliminary cost estimates for the improvements.

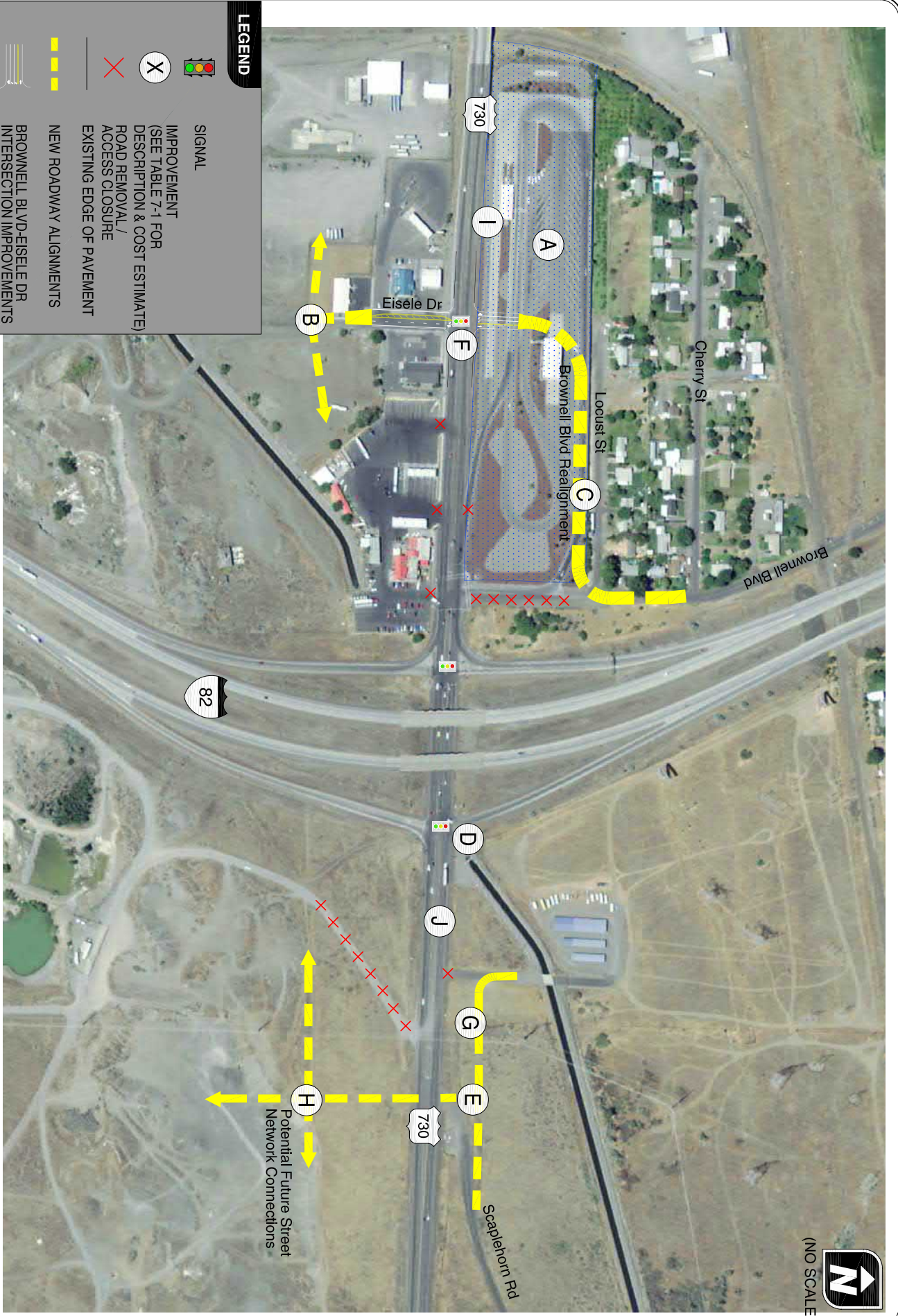



(NO SCALE)



H:\profile\110369 - I-82 US 730 IAMP.dwg\figs\IAMP\7-1b.dwg Sep 28, 2011 - 4:35pm - nfooster Layout Tab: Layout1

IAMP TRANSPORTATION IMPROVEMENT PLAN
RELOCATED POE AND NECESSARY ACCESSORY WEIGHING FACILITIES
UMATILLA, OREGON

FIGURE
7-2

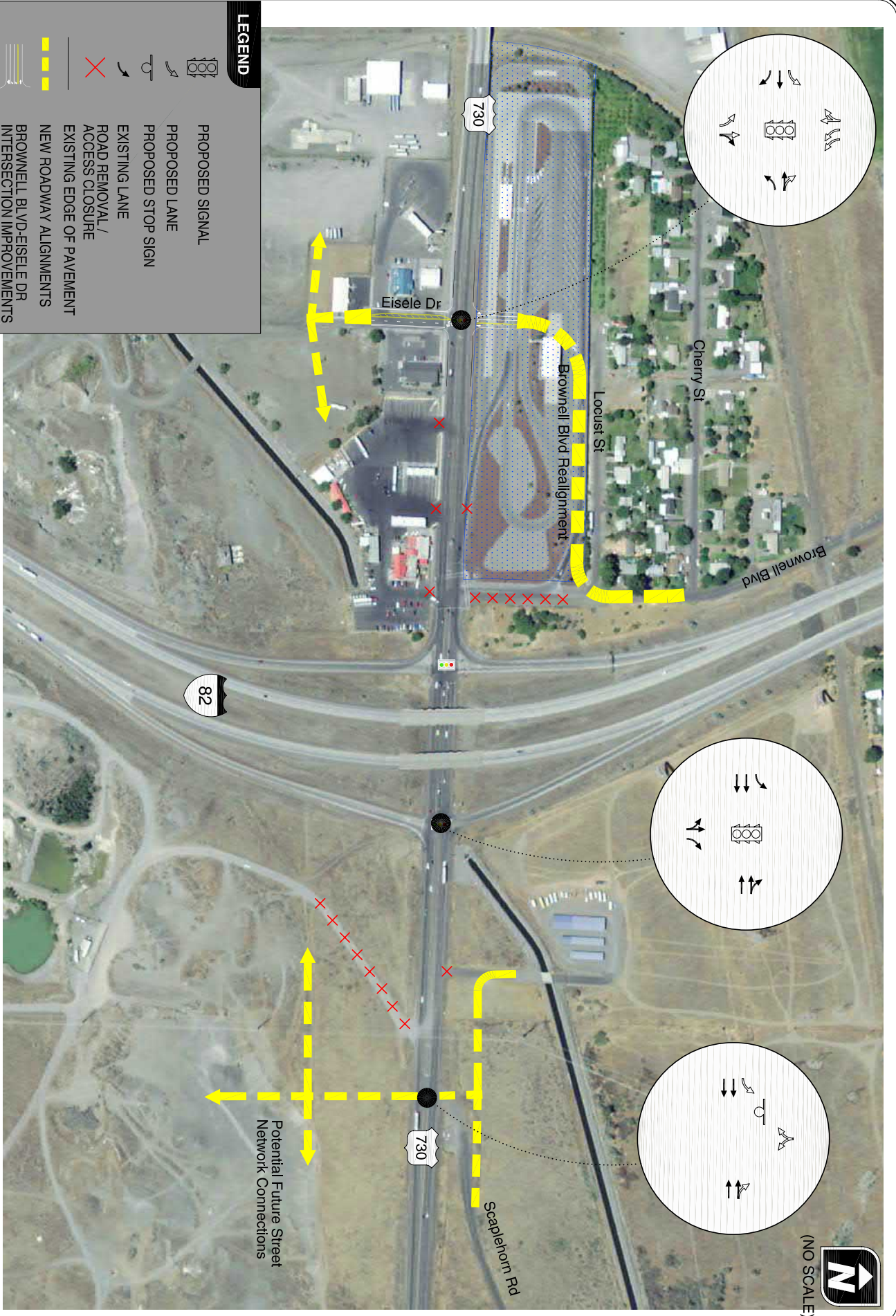

TABLE 7-1 IAMP TRANSPORTATION IMPROVEMENTS

	Improvement/Description	Trigger for Improvement	Estimated Cost¹	Potential Funding Source
A	Relocate the POE to the I-82 corridor (see Figure 7-1b and 7-3) and construct a permanent weigh station on US 730 (location to be determined via a separate study) and a temporary truck scale on US 395 (location to be determined via a separate study).	Relocation of POE	\$21M	STIP
B	Construct a new backage road accessed via Eisele Drive to provide access and circulation for properties along the south side of US 730.	Redevelopment of parcels along the south side of US 730.	\$0.7M	PDF
C	Realign Brownell Boulevard to connect to US 730 across from Eisele Drive (exact alignment of Brownell Boulevard to be determined based on future development or City project).	The need to realign Brownell Boulevard will be evaluated in a TIS when 95th-percentile westbound queues (at the existing US 730/Brownell Boulevard intersection) exceed two vehicles and spillover into the I-82 Southbound ramp terminal. Based on a sensitivity analysis of traffic operations, this condition is forecast to occur when the total entering volume at the current intersection exceeds approximately 1,950 vehicles.	\$0.65M	PDF
D	Signalize the I-82 Northbound ramp terminal.	When signal warrants are met.	\$0.3M	STIP PDF
E	Realign Scaplehorn Road to provide a longer perpendicular section.	Redevelopment of parcels along the north side of US 730.	\$0.15M	PDF
F	Signalize the US 730/Eisele Drive/Brownell Road intersection.	When Brownell Boulevard is realigned and when signal warrants are met.	\$0.3M	PDF
G	Extend Scaplehorn Road west to create a frontage road.	Redevelopment of parcels along the north side of US 730.	\$0.2M	PDF
H	Develop a network of local streets that align across from the new Scaplehorn Road intersection.	Redevelopment of parcels along the south side of US 730.	TBD ²	PDF
I	Construct sidewalks on the north side of US 730 from the Umatilla River bridge to the I-82 Southbound ramp terminal	Redevelopment of parcels along the north side of US 730 and roadway improvement projects along US 730	\$0.4M	STIP City PDF
J	Construct sidewalks on both sides of US 730 from the I-82 Southbound ramp terminal to US 395	Redevelopment of parcels and roadway improvement projects along US 730	\$2.0M	STIP City PDF

¹Includes preliminary construction and right-of-way cost estimates based on 2010 dollars.

²Improvements to be constructed by future development.

STIP – Statewide Transportation Improvement Program (ODOT)

PDF – Private Development Funds (Private Parties)

TIS – Traffic Impact Study

The following section provides details on the major improvements identified in the Transportation Improvement Plan, including possible deviations from standards that may be required.

Major Improvements

Relocating the existing POE is the central component of this plan. As was discussed in greater detail in Section 6, the POE in its current location serves as a gateway to Umatilla. The amount of truck traffic it brings into the area during peak harvest times is a significant factor behind the existing traffic issues at the interchange. It was determined that relocating the POE would likely cost as much or less than modifying the interchange to continue to accommodate the POE in the long-term. As such, the plan identifies a potential relocation site for the POE, shown in Figure 7-2, south of the I-82/US 730 interchange along the I-82 corridor. This location would allow for the POE to be rebuilt with a larger footprint capable of accommodating more overnight truck parking than the current location allows. The relocated POE would have dedicated on- and off-ramps via I-82 southbound. Figure 7-4 provides a detailed conceptual drawing of the relocated POE.

Given that the relocated POE would only have direct access via I-82 Southbound, this single site is no longer able to effectively serve and enforce the weigh process for trucks traveling along the US 395 and US 730 corridors. As such, this plan necessitates the development of a permanent weigh station on US 730 (somewhere west of Umatilla) and a truck scale to be used as needed along US 395 (somewhere south of US 730). The identification of sites for these facilities has not been completed as part of this process, and therefore no locations are shown. However, rough cost estimates of these facilities (based on a typical design shown in Figure 7-5) are included in the estimate shown in Table 7-1.



POE drawing is for illustration purposes only and represents a concept, not a design

PRELIMINARY COPY
INFORMATION ONLY

DRAWING PROVIDED BY
ANDERSON-PERRY & ASSOCIATES

RELOCATED POE
CONCEPTUAL DRAWING
UMATILLA, OREGON

FIGURE
7-4



(NO SCALE)

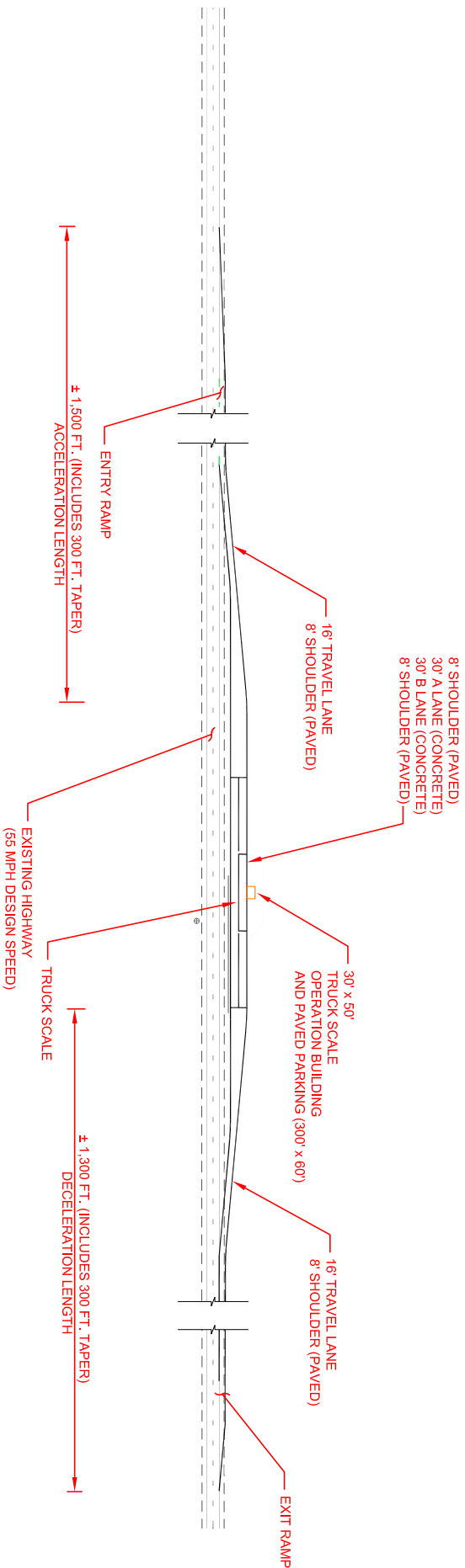

**PRELIMINARY COPY
INFORMATION ONLY**

DRAWING PROVIDED BY
ANDERSON-PERRY & ASSOCIATES

NOTE:
ACCELERATION AND DECELERATION
LENGTHS BASED ON AN ASSUMED
HIGHWAY DESIGN SPEED OF 65 MPH.

TYPICAL TRUCK SCALE
CONCEPTUAL DRAWING
UMATILLA, OREGON

FIGURE
7-5

Brownell Boulevard

Relocating the POE allows for Brownell Boulevard to be realigned through the site and intersect US 730 directly across from Eisele Drive. Such realignment would significantly improve the intersection spacing between Brownell Boulevard and the I-82 SB ramp terminal and move in the direction of achieving the desirable ¼-mile spacing standard. This Brownell Boulevard realignment is envisioned to occur over time, but only after the POE is potentially relocated. To ensure that the realignment occurs as envisioned, the IAMP has laid out the following steps that ODOT, the City of Umatilla, and Umatilla County should take following POE relocation:

1. ODOT and the City of Umatilla will enter into a memorandum of understanding (MOU) that establishes parameters for the sale of the POE site. Specific details of the agreement should include the following:
 - a. ODOT will go through a process to surplus the property.
 - b. Sale of the POE property will exclude the land necessary to establish the right-of-way to establish the Brownell Boulevard realignment as illustrated in Figure 7-1.
 - c. The excluded property should be sufficient to accommodate the Minor Arterial standard in the City's Transportation System Plan. This includes two 12 feet travel lanes, a 14 feet center turn lane, two 6 feet bike lanes, two 5 feet planting strips, and two 6 feet sidewalks. In addition to this cross-section, Figure 7-3 illustrates the recommended Brownell Boulevard approach to US 730 based on the traffic analysis (dual southbound left-turn lanes and a shared through/right-turn lane onto US 730, with approximately 125 feet of storage for the left-turn lanes).
2. Construction of the actual Brownell Boulevard realignment will occur as part of future redevelopment of the POE site. A trigger point for the realignment should occur when 95th-percentile westbound queues (at the existing US 730/Brownell Boulevard intersection) exceed two vehicles and spillover into the I-82 Southbound ramp terminal. Based on a sensitivity analysis of traffic operations, this condition is forecast to occur when the total entering volume at the current intersection exceeds approximately 1,950 vehicles. This is the equivalent of year 2030 traffic conditions with the POE relocated and approximately 50,000 square-feet of retail development on the current POE site.
3. After full realignment of Brownell Boulevard, the City of Umatilla will take over ownership and maintenance responsibility from Umatilla County.

Eisele Drive and Backage Road

To better manage access along the south side of US 730, right-of-way should be acquired as part of future redevelopment projects to the east and west of Eisele Drive. A new backage road would then be constructed to link all of the properties on the south side of US 730. This backage road will be constructed as part of future redevelopment to a Collector standard in the City's transportation

system plan. This includes two 12 feet travel lanes, a 12 feet center turn lane, two 6 feet bike lanes, two 5 feet planting strips, and two 6 feet sidewalks.

The US 730/Eisele Drive intersection will be signalized with the realignment of Brownell Boulevard. At this point, or when development of the backage road occurs, whichever is first, the Eisele Drive approach should be widened to provide an exclusive left-turn lane.

I-82/US 730 Northbound Ramp Terminal

On the east side of the interchange, signalize the I-82/US 730 Northbound ramp terminal. Signalization is anticipated to be needed to accommodate peak hour travel demand from continued traffic growth at the interchange.

Scaplehorn Road and Local Circulation

The geography of the area precludes moving the Scaplehorn Road access east to better meet access spacing standards. Instead, as development occurs north of US 730 on the east side of the interchange, the perpendicular section of the Scaplehorn Road approach to US 730 will be lengthened to approximately 200 feet to provide stacking distance for vehicles turning onto US 730. Scaplehorn Road will also be extended to serve as a frontage road that provides access for these properties. Similarly, as development occurs on the south side of US 730 on the east side of the interchange, a local street network that accesses US 730 at the Scaplehorn Road intersection will need to be constructed. These circulation and access connections are illustrated in Figure 7-1.

Pedestrian Improvements

Pedestrian facilities along US 730 in the study are currently limited to the south side of US 730 on the west side of the interchange. Sidewalks along with curb and gutter will be constructed on the north side of US 730 from the interchange to the bridge over the Umatilla River as development occurs and/or roadway improvements are made. They will also be constructed on both sides of US 730 east of the interchange to the US 395 intersection as development occurs and/or roadway improvements are made.

Possible Exceptions/Deviations from Standards

The deviations that will be required for the near-term improvements are related to the access spacing standards outlined under Oregon Administrative Rule 734, Division 51 and the Oregon Highway Plan (OHP). These deviations are discussed in the access management subsection below.

ACCESS MANAGEMENT PLAN

Access locations within the IMSA were evaluated based on ODOT's Division 51 Access Management standards and an assessment of traffic operations and safety as described in Action 3C.3 of the 1999 Oregon Highway Plan. Accordingly, an Access Management Plan (AMP) is developed to preserve the operational integrity and safety of primary roadways (e.g. US 730) serving the interchange area, while maintaining viable access to all parcels in the IMSA. The AMP contains both a plan for actions to be taken on City and County of Umatilla roadways (i.e. SW

Eisele Drive and Brownell Boulevard) and adopted into the City's and County's TSPs, respectively, and a plan, which is implemented by ODOT on state highway facilities (i.e., I-82, US 730) and adopted into the OHP as part of the facility plan.

An AMP is identified for the near-, medium-, and long-term timeframes. The overall AMP is illustrated in Figure 7-6. Justification is also provided for locations where deviations from ODOT's access management standards are necessary. Access management will be implemented as part of ODOT, City, and County project development and delivery processes or as future land use changes occur.

General Access Management Implementation

Under ODOT's current access management policy, the 1999 Oregon Highway Plan stipulates that the desired distance between an interchange ramp terminal and the first full approach (public or private) on the crossroad should be a minimum of 1,320 feet (¼-mile). The first right-in/right-out access should be a minimum of 750 feet from the ramp terminal. Currently there are 4 private approaches and 3 public street approaches on the west side of the interchange and 2 private and 1 public approaches on the east side within 1,320 feet of the interchange ramp terminals, as was previously documented in Figures 4-6 and 4-7.

Existing Private Approach Policy

ODOT guarantees Access Permit protection, as allowed within ORS 374.305 & 310, to all existing private accesses. Each will remain a valid access as long as the existing uses remain on property/site and there is no capital improvement project that would trigger review of the access (per OAR 734.051.0285). An access evaluation will be required when any of the following land use actions leads to a peak hour increase in 50 trips or more over the prior use, a daily increase of 500 trips or more over the prior use, or the increase represents a 20 percent or more increase in trips on a typical day/peak hour; if there is an identified safety or operational problem related to the approach; if the approach does not meet sight distance requirements; or if the daily traffic using the approach increases by 10 or more vehicles with a gross vehicle weight equal to or greater than 26,000 pounds:

- Modifications to existing zoning,
- Changes to plan amendment designations;
- Construction of new buildings;
- Increases in floor space of existing buildings;
- Division or consolidation of property boundaries;
- Changes in the character of traffic using the driveway/approach;
- Changes to internal site circulation design or inter-parcel circulation; or
- Reestablishment of a property's use (after discontinuance for four years or more that trigger a Traffic Impact Assessment as defined below) that occurs on the parcels served by the approaches.

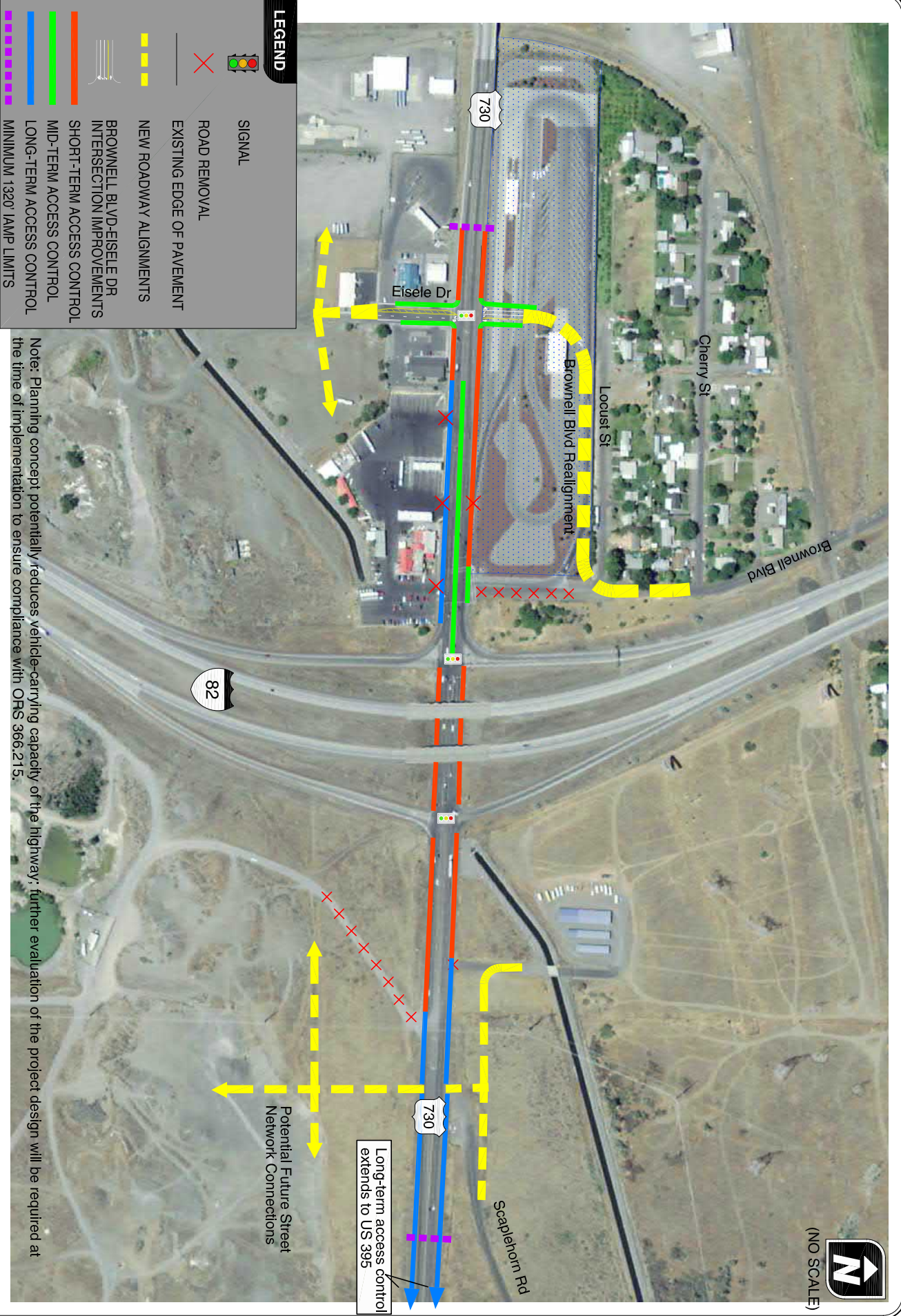

LEGEND

- SIGNAL
- ROAD REMOVAL
- EXISTING EDGE OF PAVEMENT
- NEW ROADWAY ALIGNMENTS
- BROWNELL BLVD-EISELE DR INTERSECTION IMPROVEMENTS
- SHORT-TERM ACCESS CONTROL
- MID-TERM ACCESS CONTROL
- LONG-TERM ACCESS CONTROL
- MINIMUM 1320' IAMP LIMITS

Note: Planning concept potentially reduces vehicle-carrying capacity of the highway; further evaluation of the project design will be required at the time of implementation to ensure compliance with ORS 366.215.



Long-term access control extends to US 395

Potential Future Street Network Connections

ACCESS MANAGEMENT PLAN
UMATILLA, OREGON
FIGURE 7-6

In general, the types of improvements identified for accesses within the IMSA include:

- Modifying, mitigating, consolidating, or removing existing approaches pursuant to an access management plan as part of the highway project development and delivery process (OAR 734-051);
- Improving traffic safety and operations by improving the local street network to provide alternate access and reduce conflict points; and,
- Restricting highway access but improving local roadway access by introducing shared access, cross-over easements, and/or consolidated access when separate parcels are assembled for redevelopment, and access via collector or local streets.

The time period over which the following measures will be implemented will depend on the rate of redevelopment within the IMSA and when the transportation improvement plan projects identified previously are constructed. As each parcel redevelops, or upon capital improvement, accesses will be evaluated to determine how they will be modified in order to move in the direction of meeting the access spacing standards and long-term vision of driveway consolidation while still providing access as defined in OAR 734-051.

Access Management

Figure 7-6 illustrates the AMP for the IMSA. The AMP is divided into three timeframes: near-term, mid-term, and long-term. The near-term plan illustrates how access will be controlled with the initial construction of identified near-term improvements. After the near-term improvements are constructed, ODOT and the City could then begin implementing the mid-term plan, based upon parcels redeveloping or safety and operational needs warranting access restrictions. The long-term plan would be implemented once the long-term improvements are constructed. The following is a description of the AMP for each major roadway.

US 730

The AMP for US 730 is primarily focused on not allowing new private accesses to the highway within ¼-mile of the interchange ramps. It also focuses on minimizing existing approach connections over time through closures, and consolidations, supported by alternate access provided via a backage road connecting to Eisele Drive. This plan will be implemented in the near-, mid-, and long-term time frames as outlined in Figure 7-6. In the mid-term, Brownell Boulevard will be realigned across from Eisele Drive in order to improve access spacing and provide access to the potential future redevelopment of the current POE site. Brownell Boulevard will be the closest full access to the interchange on the north side of US 730. In the long-term, the remaining accesses in this segment of US 730 between the interchange and Umatilla River Road may be restricted to right-in/right-out access by a raised center median that will be constructed to address future operational and/or safety issues. The existing accesses onto the south side of US 730 on the west side of the interchange may remain as right-in/right-out accesses after the backage road is constructed and until redevelopment occurs. At this time a review of the accesses will determine whether they remain.

A similar approach is taken on the east side of the interchange as well. Access points will be consolidated when possible as properties redevelop. When possible access will be provided via public street connections, including both existing roadways and the future south side street network shown on Figure 7-6.

Eisele Drive

The access management plan for Eisele Drive is to move accesses as far south as is practical over time in order to minimize conflicts near its signalized intersection with US 730.

Brownell Boulevard

The access management plan for Brownell Boulevard is to not allow any accesses within the 250 feet of storage needed for left-turning traffic onto US 730 when it is realigned.

Deviations to the Division 51 Access Management Standards

A few accesses will not meet the applicable OAR Division 51 access spacing standard, and as such, deviations are required to address them. These deviations will be reviewed by the Region Access Management Engineer. Under the provisions, the Region Access Management Engineer may approve a deviation if:

- (a) Adherence to spacing standards creates safety or traffic operation problems;*
- (b) The applicant provides a joint approach that serves two or more properties and results in a net reduction of approaches to the highway;*
- (c) The applicant demonstrates that existing development patterns or land holdings make joint use approaches impossible;*
- (d) Adherence to spacing standards will cause the approach to conflict with a significant natural or historic feature including trees and unique vegetation, a bridge, waterway, park, archaeological area, or cemetery;*
- (e) The highway segment functions as a service road;*
- (f) On a couplet with directional traffic separated by a city block or more, the request is for an approach at mid-block with no other existing approaches in the block or the proposal consolidates existing approaches at mid-block; or*
- (g) Based on the Region Access Management Engineer's determination that:*
 - (A) Safety factors and spacing significantly improve as a result of the approach; and*
 - (B) Approval does not compromise the intent of these rules as set forth in OAR 734-051-0020 (Which states: The purpose of Division 51 rules is to provide a safe and efficient transportation system through the preservation of public safety, the improvement and development of transportation*

facilities, the protection of highway traffic from the hazards of unrestricted and unregulated entry from adjacent property, and the elimination of hazards due to highway grade intersections.)

The following is a description of the justification for deviation for each of the public accesses requiring a deviation.

Public Access to Eisele Drive

A deviation to the access spacing requirements identified in OAR Division 51 is required at the US 730/Eisele Drive (and future Brownell Boulevard) intersection, which is located approximately 1,050 feet west of the I-82 Southbound ramp terminal, as shown in Figure 7-6. As was mentioned above, a deviation may be approved if:

(b) The applicant provides a joint approach that serves two or more properties and results in a net reduction of approaches to the highway;

Response: Eisele Drive will provide access to properties on the south side of US 730, which will facilitate the consolidation of private accesses onto US 730. Brownell Boulevard will provide access to properties on the north side of US 730, ensuring that new accesses onto US 730 are not needed.

(g) Based on the Region Access Management Engineer's determination that:

(A) Safety factors and spacing significantly improve as a result of the approach; and

(B) Approval does not compromise the intent of these rules as set forth in OAR 734-051-0020 (Which states: The purpose of Division 51 rules is to provide a safe and efficient transportation system through the preservation of public safety, the improvement and development of transportation facilities, the protection of highway traffic from the hazards of unrestricted and unregulated entry from adjacent property, and the elimination of hazards due to highway grade intersections.)

Response: This access management plan improves the existing spacing to the nearest signalized intersection and meets the intent of the Division 51 rules as it reduces vehicle turning conflicts within the interchange access management area, and protects the flow of highway traffic traveling to/from the interchange by facilitating the consolidation of accesses.

Public Access to Scaplehorn Road

A deviation to the access spacing requirements identified in OAR Division 51 is required at the US 730/Scaplehorn Road (and future south side circulation road) intersection, which is located approximately 800 feet east of the I-82 Northbound ramp terminal, as shown in Figure 7-6. As was mentioned above, a deviation may be approved if:

(b) The applicant provides a joint approach that serves two or more properties and results in a net reduction of approaches to the highway;

Response: Scaplehorn Road provides access to properties on the north side of US 730, which will facilitate the consolidation of private accesses onto US 730 and ensure that new accesses are not needed. The new circulation roadway will provide access to properties on the south side of US 730, consolidating existing access and ensuring that new accesses onto US 730 are not needed.



Section 8
Implementation Plan

Implementation Plan

This section describes the IAMP implementation strategy, which includes an I-82/US 730 Interchange Function and Policy Definition and Management Area. The Implementation Plan also includes adoption and monitoring procedures that will ensure transportation improvements are constructed and funded as development occurs and that the improvement plan is updated as needed over time.



To ensure that the IAMP remains dynamic and responsive to changes to the adopted land use and transportation plans, the City of Umatilla, Umatilla County, and ODOT should, at a minimum:

- Amend their respective Transportation System Plans and Comprehensive Plans;
- Amend the Oregon Highway Plan (OHP);
- Codify and map an IAMP Management Area that defines the area wherein regulations and requirements associated with protecting the interchange apply;
- Coordinate planning activities pursuant to the Transportation Planning Rule (OAR 660-012);
- Review the IAMP and mobility standards for the interchange prior to adopting local plan amendments.

PLAN ELEMENTS

In addition to adoption of the IAMP described in Section 7, implementation of the I-82/US 730 IAMP requires adoption of an “Interchange Function and Policy Definition” and IAMP Management Area.

Interchange Function and Policy Definition

The City of Umatilla and Umatilla County should adopt a clear definition of the I-82/US 730 Interchange function into their respective comprehensive plan and TSP as a policy to provide direction for management of the interchange area and achieve the objectives and goals of this IAMP. This will help to ensure consistency between future policy decisions with the interchange’s intended function.

The I-82/US 730 interchange provides connections between the I-82, US 730, and US 395 corridors. I-82 is a short, but significant interstate highway that connects the state of Washington to the I-84 corridor. I-82 is classified as an Interstate Highway by the Oregon Highway Plan (OHP) and designated as an Expressway and Statewide Freight Route. US 730 is a Regional Highway that provides regional connectivity between numerous local jurisdictions and the I-82/I-84 interstate highways.

Based on this description, the following function and policy definition was developed for the I-82/US 730 Interchange:

“The primary transportation function of the I-82/US 730 interchange is to facilitate statewide, inter-urban, and inter-regional travel between I-82, US 730, and US 395. In addition to this primary function, the I-82/US 730 interchange provides east-west inter-regional connectivity across I-82 for the City of Umatilla and surrounding land uses. Beyond these primary functions, the interchange provides an inter-regional connection that supports local, regional, and state business interests.”

IAMP Management Area

The City of Umatilla is the land use regulatory authority for most of the IMSA; for land that is located outside of the City’s UGB, Umatilla County is the land use regulatory authority. To ensure the continued operation and safety integrity of the interchange, both the City of Umatilla should adopt an IAMP Management Area. Future development and land use actions within the IAMP Management Area will be monitored to ensure that volume-to-capacity ratios do not exceed the adopted Oregon Highway Plan mobility standards at the ramp terminals. This can be accomplished through Development Review guidelines included within the proposed amendments to the City’s Land Use and Development Ordinances as described in the following sections

ADOPTION ELEMENTS

Implementation of the I-82/US 730 IAMP will occur at several levels of government. As required by OAR 734-051, the City of Umatilla and Umatilla County will be required to legislatively amend their Transportation System Plans and Comprehensive Plans to incorporate elements of the I-82/US 730 IAMP. In addition, new ordinances or amendments to existing ordinances, resolutions, and Inter-Governmental Agreements (IGAs) will be required to ensure that the access management, land use management, and coordination elements of the IAMP are achieved. This adoption process will include Planning Commission/City Council hearings at the city level and Planning Commission/County Board of Commissioners hearings at the County level. Following successful adoption at the City and County levels, the I-82/US 730 IAMP will be presented to the Oregon Transportation Commission (OTC) for its review and adoption. This should occur prior to transportation improvements as described in this IAMP being constructed.

To implement the I-82/US 730 IAMP, the following actions shall occur:

1. The City of Umatilla shall adopt the I-82/US 730 IAMP as part of the City of Umatilla Transportation System Plan and Comprehensive Plan. The IAMP, and more specifically the transportation improvements identified in Table 7-1 of Section 7, shall serve as the long range comprehensive management plan for providing the transportation facilities that are specifically addressed in this plan, as well as the Access Management Plan and the planned local street network for the area.
2. Umatilla County shall adopt the I-82/US 730 IAMP as part of the Umatilla County Transportation System Plan and Comprehensive Plan. The IAMP shall serve as the long range comprehensive management plan for providing the transportation facilities that are



specifically addressed in this plan, as well as the Access Management Plan and the planned local street network for the area.

3. The City of Umatilla shall amend its Comprehensive Plan Map and Zoning Map to include the IAMP Management Area boundary. In addition, the City shall amend the Land Use and Development Ordinance to include development and land use application requirements pertaining to transportation impact analysis, access management, and agency coordination.
4. Umatilla County shall amend its Comprehensive Plan Map and Zoning Map to include the IAMP Management Area boundary. In addition, the County shall amend the Land Use and Development Ordinance to include development and land use application requirements pertaining to transportation impact analysis, access management, and agency coordination.
5. ODOT Regional Access Management Engineer will review and approve the access deviations described in the IAMP.
6. The Oregon Transportation Commission shall amend the Oregon Highway Plan to include the I-82/US 730 IAMP.
7. The City of Umatilla, Umatilla County, and ODOT shall develop a Memorandum of Understanding (MOU) that specifies how the improvements identified in Table 7-1 of Section 7 will be addressed.

TSP Amendments

The following outline discusses the major Transportation System Plan amendments that will need to occur at the city, county, and state levels to support adoption of the I-82/US 730 IAMP.

City of Umatilla

- The City shall adopt the I-82/US 730 Interchange Area Management Plan by reference as an element of the City's Transportation System Plan.
- The following interchange policy statement shall be included in the City of Umatilla Transportation System Plan: *"The primary transportation function of the I-82/US 730 interchange is to facilitate statewide, inter-urban, and inter-regional travel between I-82, US 730, and US 395. In addition to this primary function, the I-82/US 730 interchange provides east-west inter-regional connectivity across I-82 for the City of Umatilla and surrounding land uses. Beyond these primary functions, the interchange provides an inter-regional connection that supports local, regional, and state business interests."*
- The IAMP Transportation Improvement Plan, as illustrated in Figure 7-1 and listed in Table 7-1, shall be included in the recommended transportation improvements project list of the Transportation System Plan.



Umatilla County

- The County shall adopt the I-82/US 730 Interchange Area Management Plan by reference as an element of the County's Transportation System Plan.
- Upon the County's adoption of the IAMP, parcels within the IMSA and outside the UGB will be subject to the IAMP's Access Management Plan.
- The following interchange policy statement should be included in the Umatilla County Transportation System Plan: *"The primary transportation function of the I-82/US 730 interchange is to facilitate statewide, inter-urban, and inter-regional travel between I-82, US 730, and US 395. In addition to this primary function, the I-82/US 730 interchange provides east-west inter-regional connectivity across I-82 for the City of Umatilla and surrounding land uses. Beyond these primary functions, the interchange provides an inter-regional connection that supports local, regional, and state business interests."*
- The IAMP transportation improvement plan elements located on County facilities, as illustrated in Figure 7-1 and listed in Table 7-1, shall be included in the recommended transportation improvements project list of the Umatilla County Transportation System Plan.
- The IAMP Access Management Plan elements as illustrated in Figure 7-6 shall be included in the transportation improvement project list of the Transportation System Plan

Oregon Transportation Commission

- The I-82/US 730 IAMP shall be adopted by the Oregon Transportation Commission as part of the Oregon Highway Plan.

Other City Amendments

The following outlines other major amendments that will need to occur at the city level to support adoption of the I-82/US 730 IAMP.

- The City shall amend the Umatilla Code to establish a Gateway Sub-District under the General Commercial (GC) zone that addresses potential future redevelopment of the Port of Entry (POE) site. This sub-district will require specific development standards and specify restricted uses.

MONITORING ELEMENTS

The purpose of the IAMP is to ensure that capacity at the interchange is preserved for its intended function. While a long-range plan, the IAMP needs to remain dynamic and responsive to development and changes to the adopted land use and transportation plans and may need to be periodically reviewed and updated. To accomplish this goal, a monitoring program is included that identifies triggers for reviewing the IAMP and assessing how development approval within the IAMP Management Area will be reviewed and coordinated

IAMP Review Triggers

Periodically, the implementation program shall be evaluated by the City, ODOT, and County to ensure it is accomplishing the goals and objectives of the IAMP. Events that may trigger an IAMP review include:

- Plan map and zone changes that have a “significant affect” pursuant to the Transportation Planning Rule, Section -0060 and impact the I-82/US 730 Interchange, or that are located within the IAMP Management Area.
- Following relocation of the POE.
- The 95th-percentile westbound vehicle queue on US 730 exceeds two vehicles or backs into the I-82/US 730 Southbound ramp terminal.
- Mobility measures at the I-84 ramp terminals exceed the adopted volume-to-capacity ratios.

In addition to the established triggers for IAMP review, the agencies may request a review of the IAMP at any time if, in their determination, specific land use or transportation changes warrant a review of the underlying assumptions and/or recommendations within the IAMP. If the participants in the IAMP review meeting agree that, once the impacts of the “trigger” that necessitated the review are examined, an IAMP amendment is not warranted, a recommendation of “no action” may be documented and submitted in the form of a letter to the City of Umatilla City Council, Umatilla County Board of Commissioners, and the Oregon Transportation Commission.

If the findings and conclusions from the IAMP review meeting demonstrate the need for an update to the plan, review participants will initiate an IAMP update process. Initial steps in updating the IAMP will include scoping the planning process, identifying funding, and outlining a schedule for plan completion. Once completed, IAMP updates will be required to be legislatively adopted, requiring a City Council public hearing, as an amendment to the City of Umatilla Transportation System Plan and will be adopted by Umatilla County Board of Commissioners (if affected) and the Oregon Transportation Commission as an update to the Oregon Highway Plan

Development Review within the Overlay District

The following outlines the transportation requirements for development and zone change applications within the I-82/US 730 Interchange Overlay Zone and describes how The City of Umatilla and Umatilla County will coordinate with ODOT.

Traffic Impact Analysis

All development applications located within the I-82/US 730 Interchange Management Area that meet the following conditions are required to prepare and submit a Transportation Impact Analysis (TIA) to demonstrate the level of impact of the proposed development on the surrounding street system:

- a) A change in zoning or plan amendment designation; and

- b) The proposal is projected to cause one or more of the following effects, which can be determined by field counts, site observation, traffic impact analysis or study, field measurements, crash history, Institute of Transportation Engineers *Trip Generation* manual; and information and studies provided by the local reviewing jurisdiction and/or ODOT:
- i) An increase in site traffic volume generation by 250 average daily trips (ADT) or more (or as required by the City Engineer). The latest edition of the *Trip Generation* manual, published by the Institute of Transportation Engineers (ITE) shall be used as standards by which to gauge average daily vehicle trips; or
 - ii) An increase in use of adjacent streets by vehicles exceeding the 20,000 pound gross vehicle weights by 10 vehicles or more per day; or
 - iii) The location of the access driveway does not meet minimum intersection sight distance requirements, or is located where vehicles entering or leaving the property are restricted, or vehicles queue or hesitate, creating a safety hazard; or
 - iv) A change in internal traffic patterns that may cause safety problems, such as back up onto the highway or traffic crashes in the approach area; or.
 - v) For development in the I-82/US 730 Interchange Area Management Plan (IAMP) Management Area, the location of the access driveway is inconsistent with the Access Management Plan in Section 7 of the IAMP

The determination of impact or effect, and the scope of the TIA, shall be coordinated with the City of Umatilla, Umatilla County, and ODOT. The developer shall be required to mitigate impacts attributable to the project.

ODOT Coordination

- The City shall consult the Oregon Department of Transportation (ODOT) on TIA requirements when the site of the proposal is adjacent to or otherwise affects a State roadway.
- The City shall provide written notification to ODOT once the application is deemed complete.
- ODOT shall have at least 20 days, measured from the date notice to agencies was mailed, to provide written comments to the City. If ODOT does not provide written comments during this 20-day period, the City staff report will be issued without consideration of ODOT comments.
- The County shall invite ODOT to participate in a pre-filing conference for applications within an Interchange Management Area Plan (IAMP) Management Area or within a ¼ mile of any ODOT facility.

POE RELOCATION RELATED ACTIONS

A major component of the I-82/US 730 IAMP centers on a potential future relocation of the POE. Given the uncertainty of the timing and the numerous logistical details that come with the relocation, it is expected that additional actions will need to be taken by the City of Umatilla, ODOT, and Umatilla County. For guidance purposes, the Implementation section of the IAMP has identified these likely next steps.

Surplus Process

When funding becomes available and the POE is relocated, the State of Oregon will be in a position to potentially sell the existing POE site for future redevelopment. In order for this to occur, the State will first have to declare the POE site as surplus property. It is recognized that declaring the POE site as surplus property is an important first step to ensuring redevelopment of the site and some of the associated infrastructure projects envisioned in the IAMP. The most significant infrastructure change involves the realignment of Brownell Boulevard. To ensure that the realignment takes place as envisioned, ODOT will follow the policies and procedures established in Chapter 9 of ODOT's Right of Way Manual.

Brownell Realignment

Because the necessary steps for a long-term Brownell realignment involve ODOT (owner of the POE site), City (governing jurisdiction), and Umatilla County (owner of the existing Brownell Boulevard), it is anticipated that all three jurisdictions will need address the following issues when the POE site is formally relocated and redevelopment of the POE site take place.

- Timing of jurisdictional transfer of the realigned Brownell Boulevard to the City. This jurisdictional transfer is outlined in Chapter 9 of ODOT's Right of Way Manual.
- The City will establish a funding mechanism that will ensure construction of the Brownell Boulevard realignment as part of the future redevelopment of the POE.
- Land Use Permitting for the POE site

DISCLAIMER

The inclusion of proposed projects and actions in this plan does not obligate or imply obligations of funds by any jurisdiction for project level planning or construction. The inclusion of proposed projects and actions does serve as an opportunity for the projects to be included, if appropriate, in the State Transportation Improvement Program (STIP) and the local Capital Improvement Program (CIP), but such inclusion is not automatic. It is incumbent on the state, county, city, and general public to take action to encourage and support inclusion in the STIP of CIP at the appropriate time. Because a project must have actual identified funding to be included in the STIP or CIP, the ultimate number of projects that can be included in these documents is constrained by available funding. The state transportation system improvements projects that are expected to be funded by ODOT that are listed on the transportation improvement project list have no guaranteed funding at this

time and are not reasonably likely to be funded during the identified planning horizon for the purpose of addressing OAR 660-0012-0060.



Excerpts

CITY OF UMATILLA
COMMUNITY DEVELOPMENT DEPARTMENT
PARKS AND RECREATION



MASTER TRAILS PLAN

City of Umatilla
700 6th Street Umatilla, OR 9788
February 4, 2020

Table of Contents

Title Page.....	1
Executive Summary.....	2
Acknowledgements.....	3
Table of Contents.....	4
Goals & Objectives.....	5
Planning.....	6
Community Background History.....	12
Natural Resources.....	19
Historic & Cultural Resources.....	21
Inventory of Existing Facilities.....	23
Trail-Related Activities & Events.....	24
Signage.....	26
Proposed Trail Projects.....	27
Implementation Timeline.....	39
Local Partnerships.....	39
Conclusion.....	41

II. Goals and Objectives

The goal of the Umatilla Trail Plan is to create a city-wide system of trails that serve as an alternative to motorized transportation, that enhance public health and foster the development of a premier outdoor recreation experience and destination for tourism.

Objectives listed below complement the overarching goal of a city-wide trail system. The list was inspired by survey responses, City Council goals, the City Comprehensive Land Use Plan and numerous public involvement venues.

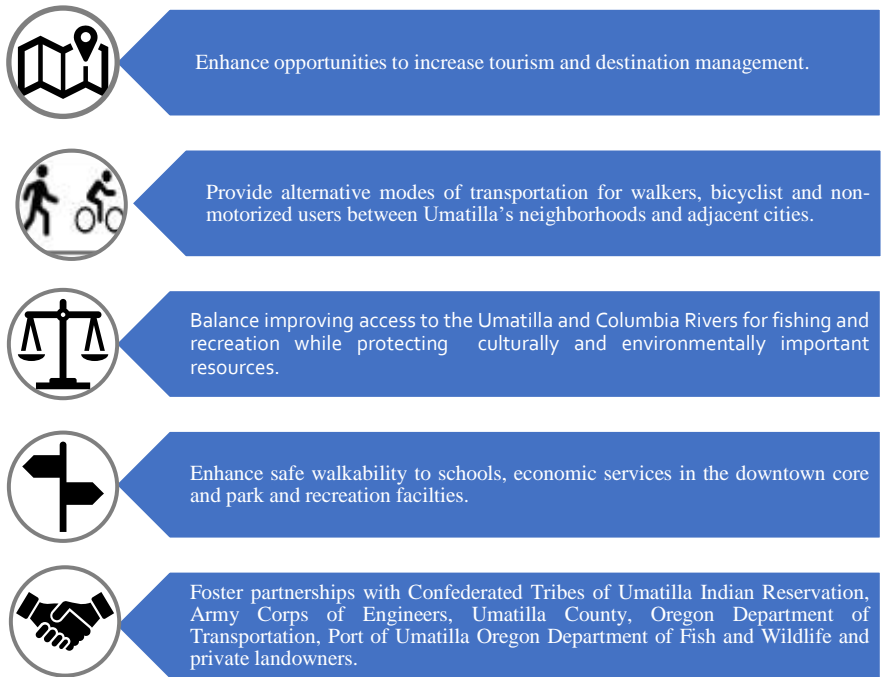

City Council Goals July 2019- June 2021

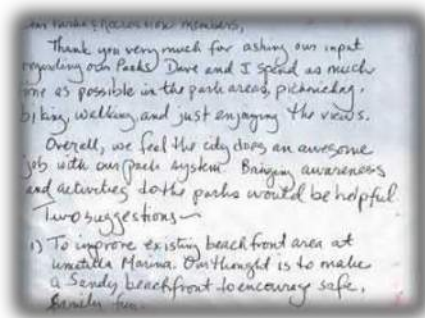

Surveys provided insight into Umatilla's citizen's recreational value

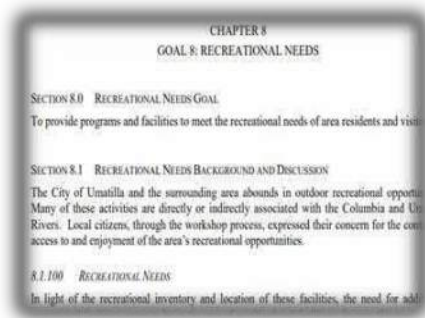

The City of Umatilla Comprehensive Land Use Plan and the Bicycle Master Plan and Chapter 8 Goal 8: Recreational Needs provided insight on City of Umatilla previous trail planning.

CITY OF UMATILLA TRAIL PLAN | PROPOSED TRAILS

Project #1 South Hill Connector

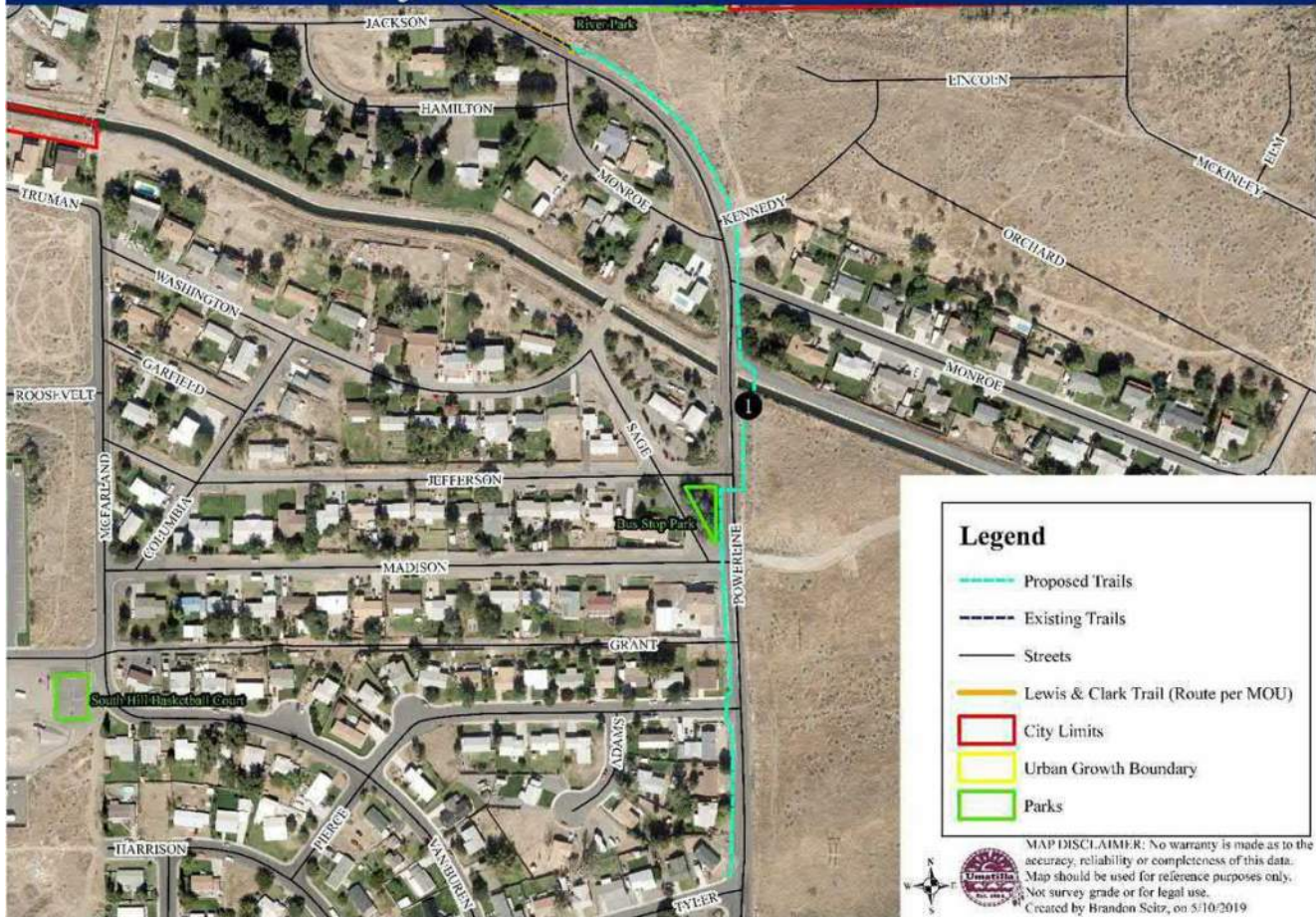

Description: Project #1 will allow pedestrians to walk on the west side of Powerline Road north towards downtown to Bus Stop Park (aka triangle park) where a new crosswalk would be constructed, and the trail would then be constructed on the east side of Powerline Road. The alignment on the east will require the construction of a footbridge crossing of the West Extension Irrigation District canal. This project will then connect to the existing asphalt trail located adjacent to Powerline Road.

CITY OF UMATILLA TRAIL PLAN | PROPOSED TRAILS

Project #2 Pave Walking/Bike Path to Foot Bridge

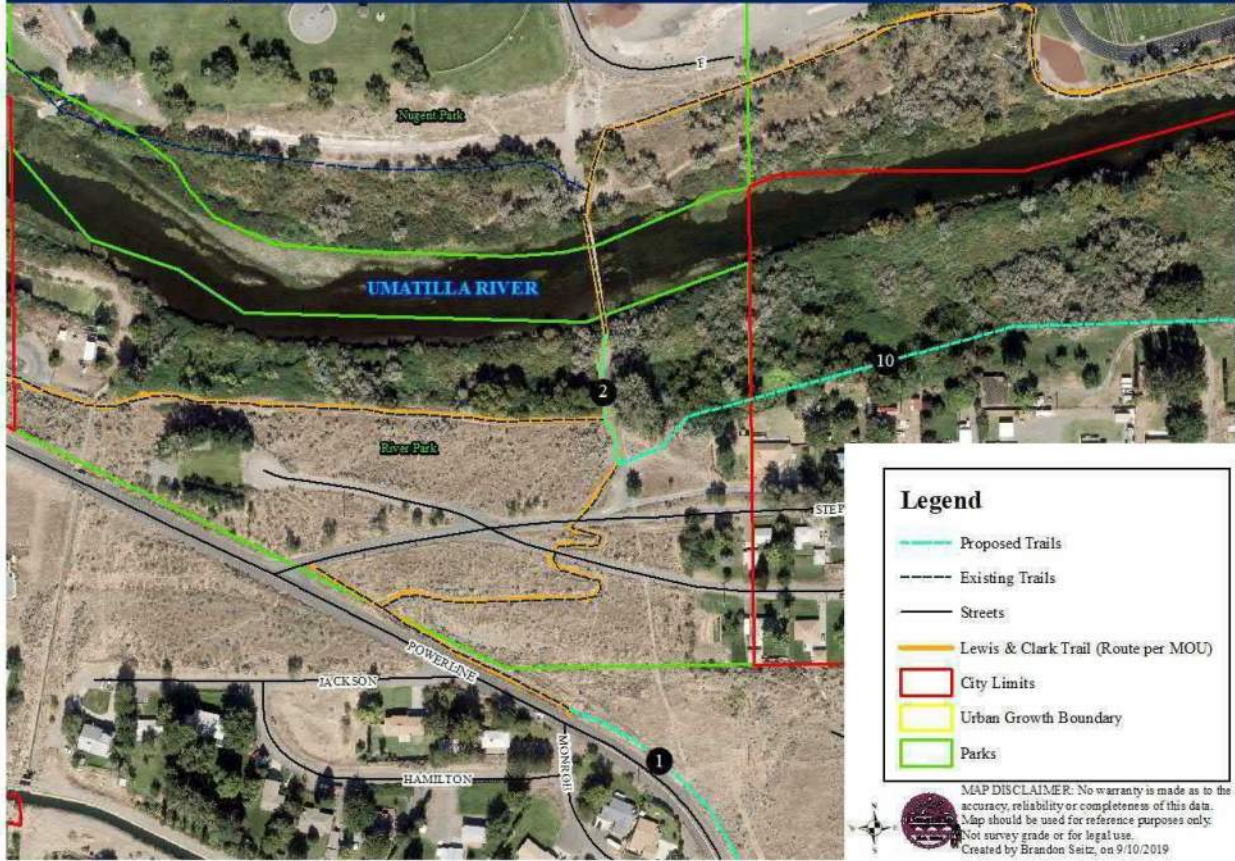

Description: Project #2 is a small stretch that connects the existing asphalt trail, shown in yellow above as Lewis & Clark trail, with the Umatilla River footbridge. On the north side of the footbridge is an asphalt trail that leads east to the high school and west to the fishing shelter. Due to slope and proximity to Umatilla River, a natural or gravel surface is likely the surface type, however, it will require further design consideration for compliance with American with Disabilities Act (ADA). Note: the spring 2019 flood seriously damaged the footbridge and it closed permanently until the City secures funding to replace the bridge. The footbridge is an important recreation feature for walking and angling. The footbridge and this section of trail are important for students who live on the South Hill and walk to school.

CITY OF UMATILLA TRAIL PLAN | PROPOSED TRAILS

Project #3 McNary Connector



Description: Project #3 will allow pedestrians in the McNary Area and Port Industrial Park to connect with sections of the existing Lewis and Clark Trail and making a large loop around the golf course and Willamette Avenue, around Kiwanis Park and back to Bud Draper Drive. This connection proposes two alignments; one alongside the golf course and the other alongside Bud Draper Road. Both alignments are feasible and have merit and are somewhat contingent upon future development plans of the city-owned parcels located between Bud Draper Drive and the golf course. For example, if the city-owned lots are developed as residential, then Route A alignment would be preferable, creating an open space buffer between housing and the golf course.

CITY OF UMATILLA TRAIL PLAN | PROPOSED TRAILS

Project #4 3rd to Main/6th Connector

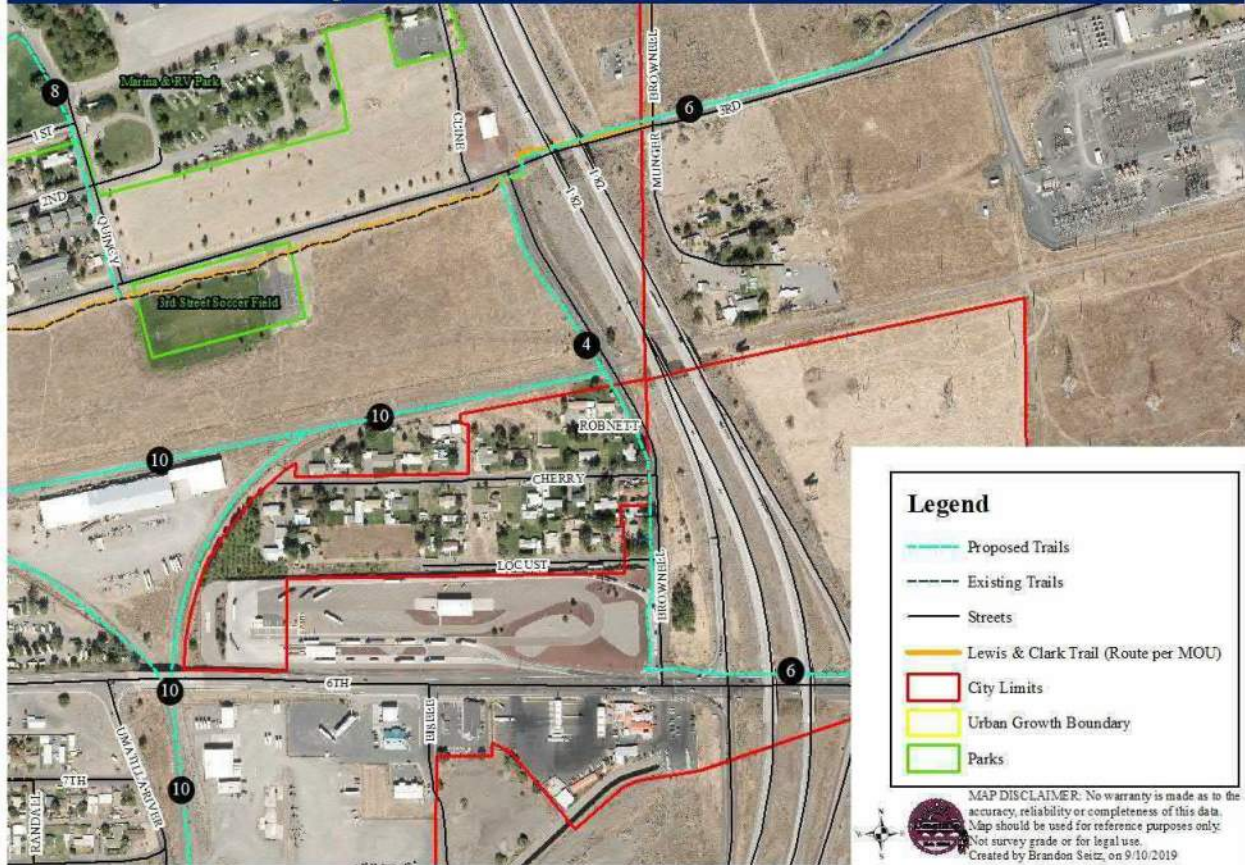

Description: Project #4 will provide a connection between the commercial area on Highway 730 to the trail on Army Corps of Engineers property south of Third Street. Currently, there is no clearly delineated area or path to walk or ride bikes along Brownell Boulevard. It is an important future connection between Marina Park and commercial areas on Highway 730. Brownell Boulevard is currently a county road and in need of surface and other improvements. When those improvements transpire and city and county negotiate to transfer the road, design of bicycle/pedestrian features should be included. As Marina Park amenities are improved and expanded, this section or trail becomes increasingly important. Additionally, when improvements are made to the Oregon Department of Transportation weigh station, consideration for bicycle and pedestrian access should be made. One short term improvement at the intersection of Highway 730 and Brownell Boulevard would be to stripe, sign and clearly mark the crosswalk.

CITY OF UMATILLA TRAIL PLAN | PROPOSED TRAILS

Project #5 Umatilla River to Landing Park Connector

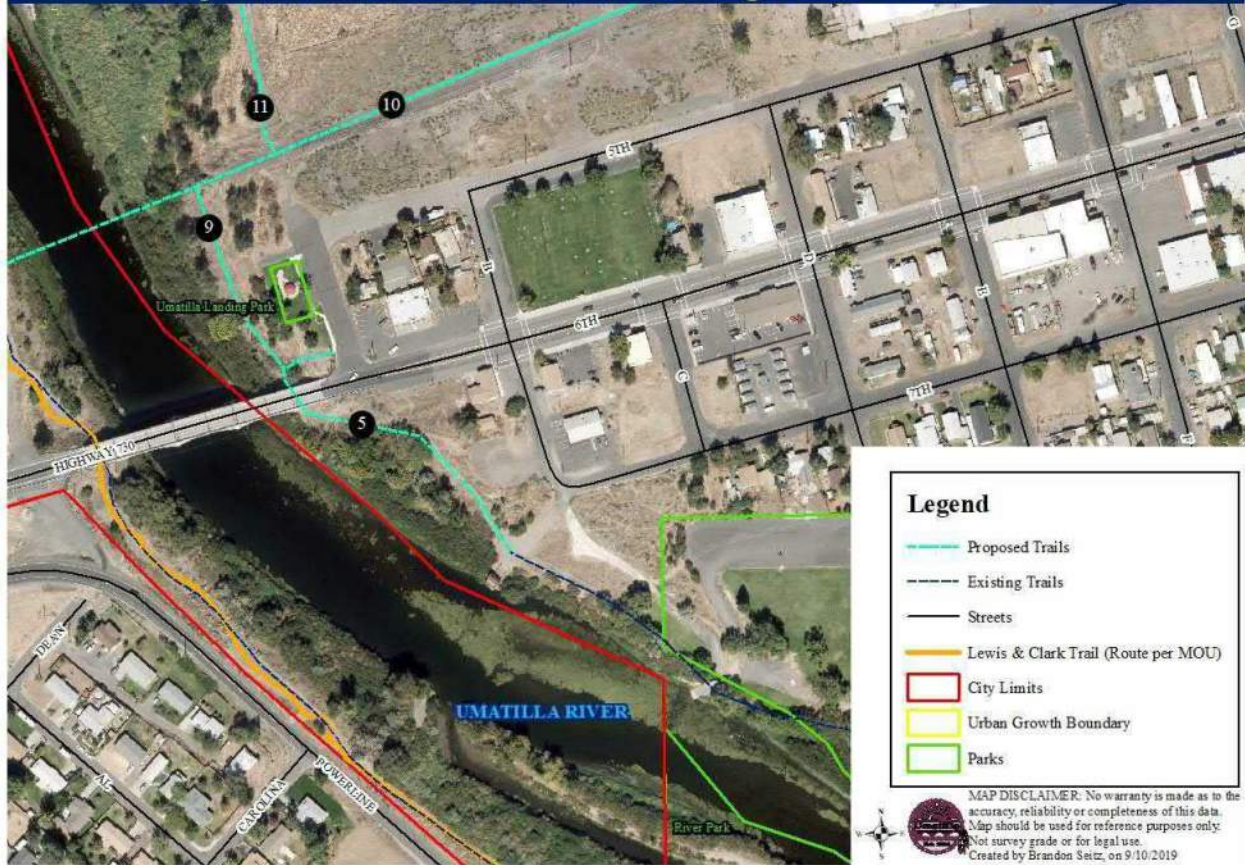

Description: Project #5 will provide an extension of the existing asphalt trail located south of Nugent Park, (which approximately aligns with the Umatilla River), to the north, continuing along the Umatilla River and under the Highway 730 bridge to Umatilla Landing Park. This trail segment would connect to the proposed trail project #9, a path through Landing Park and a bridge crossing the Umatilla River. There is presently an informal dirt footpath along this segment that is used by hikers and anglers primarily. Improving this segment would make the river more accessible to persons with disabilities and ease access from Sixth Street and Landing Park to the river. However, given the proximity to the Umatilla River there is a likelihood of archaeological sites within the proposed trail area. Those sites should be avoided. Consultation with Oregon SHPO and CTUIR during planning stages can help avoid or decrease impacts to archaeological sites.

CITY OF UMATILLA TRAIL PLAN | PROPOSED TRAILS

Project #6 McNary to Downtown Connector



Description: Project #6 will allow pedestrians to connect to the existing trails on federal lands managed by the Army Corps of Engineers (ACOE) in the McNary Wildlife to McNary Dam area. Project #6 will connect Third Street and the Marina to the McNary neighborhood. There are two possible alignments; one which would require the ACOE to add a bicycle lane along Third Street (part of Third Street has a bicycle lane) as well as city to add a bicycle lane on the city-owned section of Third Street. Another alignment option would be to create a wholly new trail on lands owned by BLM and Army Corps of Engineers, located roughly north of Highway 730.

CITY OF UMATILLA TRAIL PLAN | PROPOSED TRAILS

Project #7 McNary to McNary Beach



Description: Project #7 will allow pedestrians a connection between the McNary neighborhood and McNary Beach. Currently the only safe way to access to beach is to drive a vehicle. McNary Beach and the Columbia River are spectacular assets. Improving accessibility for McNary residents would greatly enrich the neighborhood. Alignment opportunities include a separated trail adjacent to Beach Access Road or as a striped area that is part of the roadway. This industrial area has a lot of commercial and farm truck traffic which will require special design consideration. Examples of trails within industrial areas are becoming more common, for example at the Port of Morrow. Walkers enjoy visiting industrial areas as long as the journey is safe. Project #7 would link with project #3, making a multi-faceted system for the McNary neighborhood, Port Industrial Park and McNary Beach. It may be practical in the future to pursue design and engineering of Project #3 and #7 together. As the Port property is developed and new jobs are created, a trail system would make McNary an ideal location for persons working in the Port.

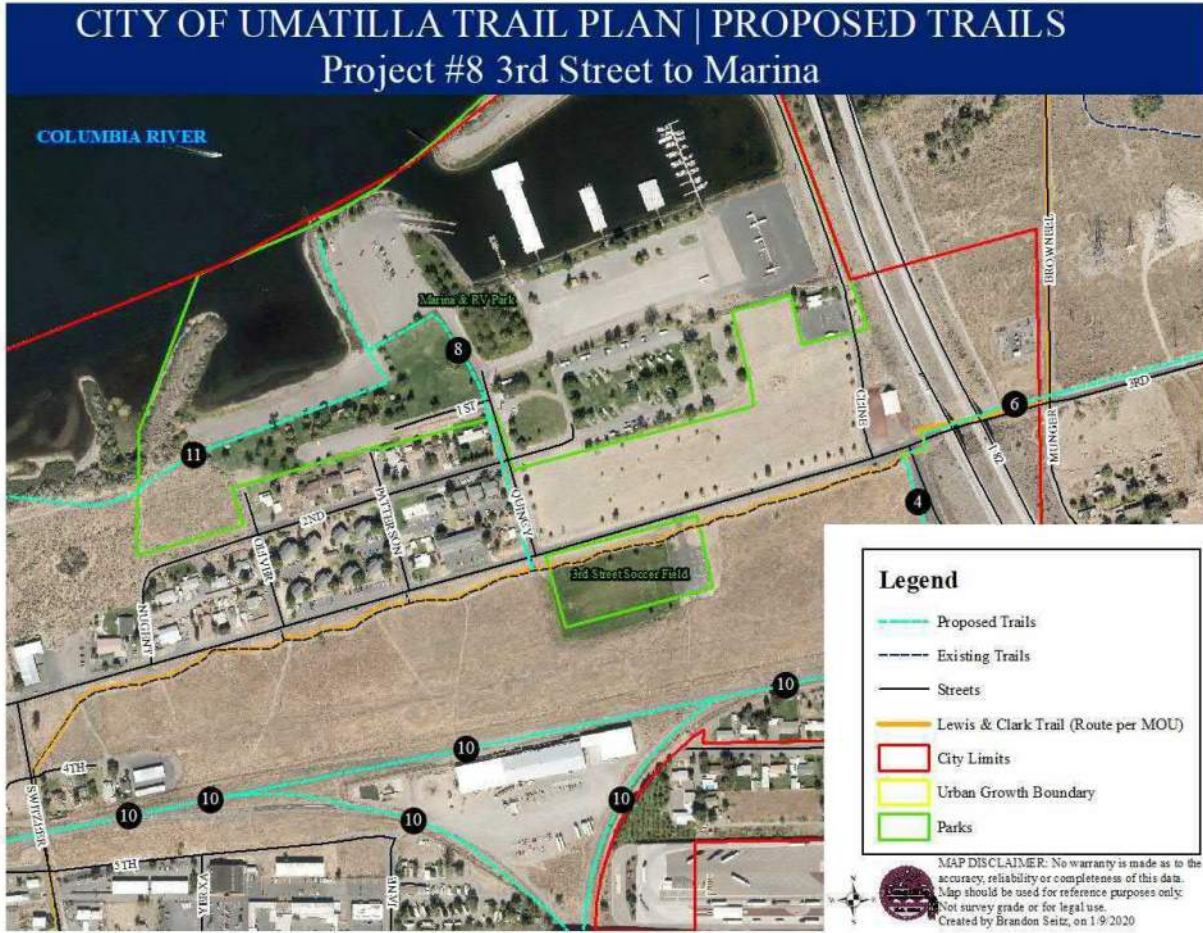

Description: Project #8 will allow a clear pedestrian/bicycle connection between the existing Third Street trail and Marina Park, as well as a connection to a trail roughly parallel to the Columbia River leading west to the confluence of the Umatilla River. Presently pedestrians can walk along Quincy Street from the soccer fields to the Marina, although there is no marking or dedicated path. It would be a relatively low investment to create to add signage and paint stripes. This project is two-part, a connection between Marina and Soccer fields and a connect between Marina and Old Town Site.

CITY OF UMATILLA TRAIL PLAN | PROPOSED TRAILS

Project #9 Umatilla River Crossing

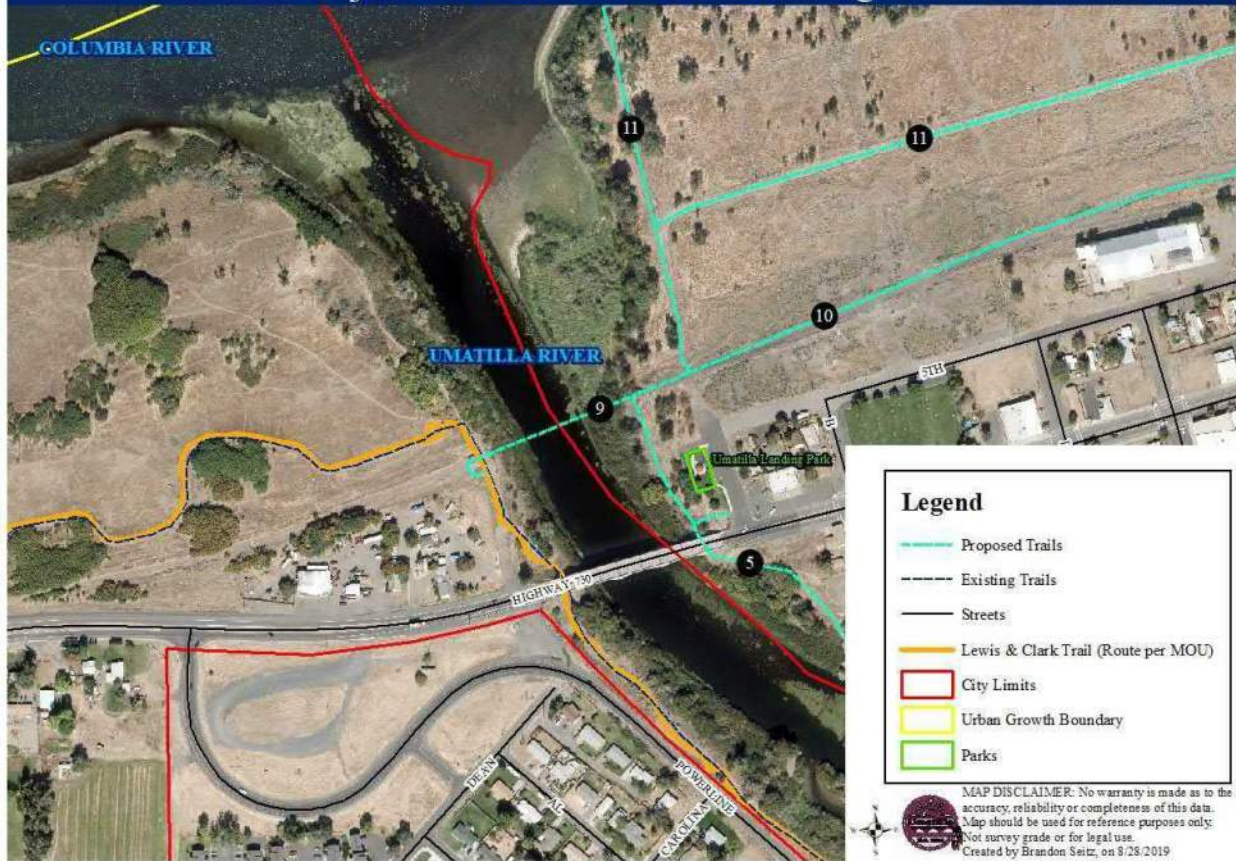

Description: Project #9 will include a new bridge across the Umatilla River, connecting the downtown area to the wildlife area on the west. Pedestrians and cyclists in the downtown area would be able to cross the Umatilla River and connect to the existing trail along the west side of the Umatilla River and avoid use of the Highway 730 bridge. The proposed project could utilize old railroad abutments on either side of the Umatilla River. The trail on the west side includes lands along the Columbia River owned by ACOE and managed by Oregon Department of Fish & Wildlife including trails that are more primitive (dirt). However, future consideration could be to enhance those trails creating additional access to the Columbia River.

CITY OF UMATILLA TRAIL PLAN | PROPOSED TRAILS

Project #10 Route to West County Trail System/Rails to Trails

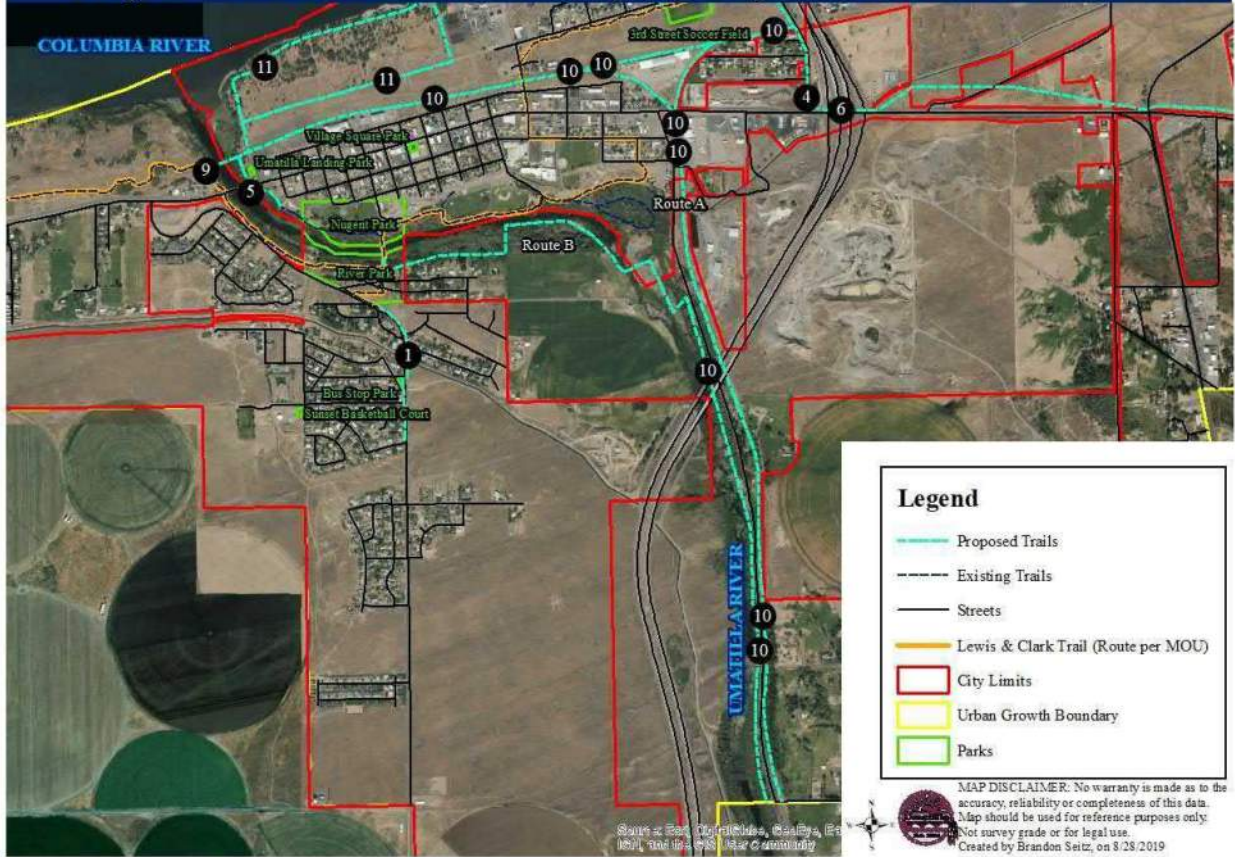

Description: Project #10 is intended to provide a connection between Umatilla and a trail along Umatilla River Road which in turn connects to the west county regional Umatilla River Trail. There are two alignment options. Route A is a direct connection beginning at the intersection of Umatilla River Road and Highway 730. Route B would be a new trail along private property, roughly parallel with the Umatilla River, and connecting the trail system adjacent to the Umatilla footbridge. This section would be located on lands owned by the Army Corps of Engineers. This Route would require a bridge crossing the Umatilla River in order to connect to Umatilla River Road, or, the trail could continue south along the west side of the Umatilla River. This is an important project in terms of providing access for anglers, hikers and as a link to the regional trail system. To that end, a dirt, gravel or bark path would like be suitable at least for the interim. Longer term, a more refined trail could include asphalt surface and footbridge, providing access to more persons including those with mobility limitations.

CITY OF UMATILLA TRAIL PLAN | PROPOSED TRAILS

Project #11 Marina to Landing Park/Old Town Trail

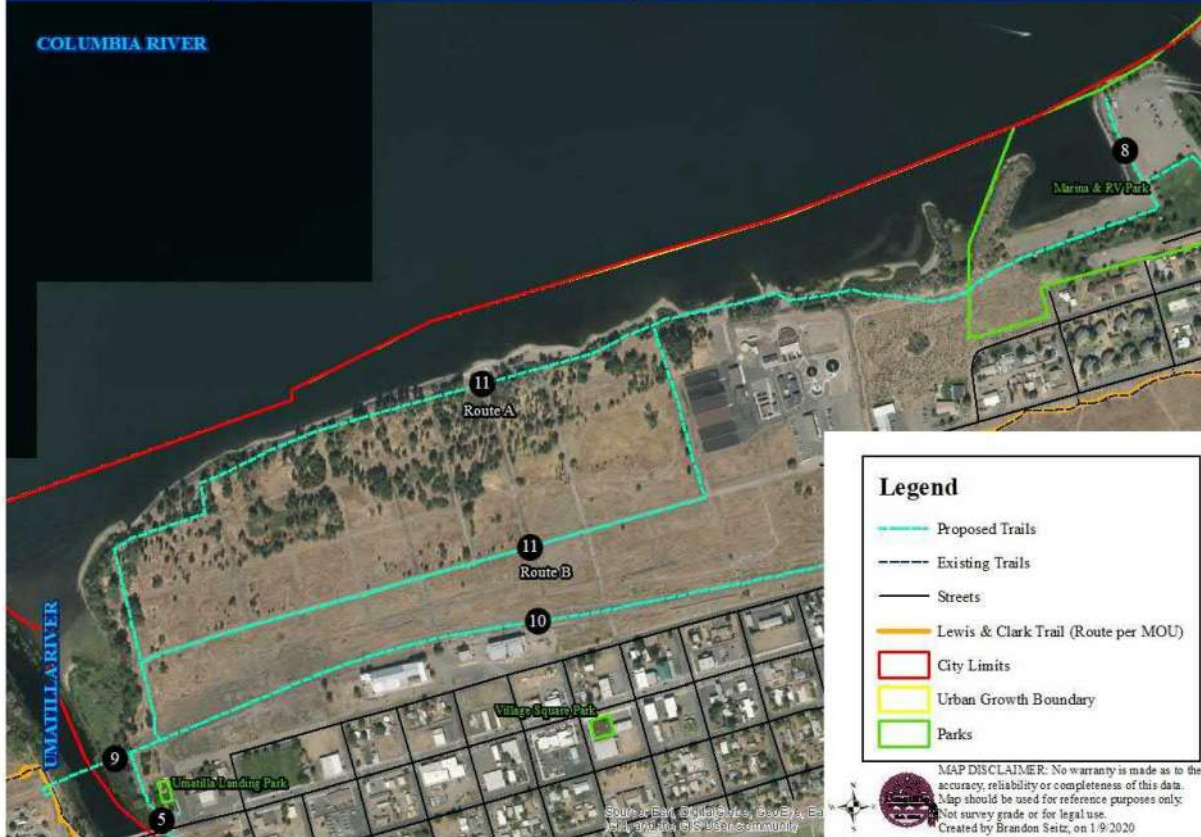

Description: Project #11 will allow pedestrians and cyclists a link between the confluence of the Umatilla and Columbia River to Marina Park. There are two possible alignments. Route A would align closely to the south shore of the Columbia River, creating an opportunity to experience the river and riverine habitat. That route would present design challenges in order to protect the archaeological sites. One remedy may be to limit the use to daylight hours only. Route B would, by contrast, be simpler since it would require use of the old, abandoned street. Both alignments will require careful coordination between US Army Corps of Engineers, CTUIR and City of Umatilla. The city and CTUIR have a landscape management plan and an agreement that sets forth the terms for allowing access to the Old Town Site. The agreement limits access to daylight hours only.

UMATILLA RIVER TRAIL



CONCEPT PLAN

JUNE 2021

Excerpts



TABLE OF CONTENTS

FOREWORD	
ACKNOWLEDGEMENTS	
ABOUT THIS DOCUMENT	Page 1
VISION MISSION AND GOALS	Pages 2-3
FREQUENTLY ASKED QUESTIONS	Pages 4-5
INTRODUCTION	Pages 6-25
Project Area	Page 7
Demographics	Page 7
Community Health Profile	Pages 8-9
Planning Process	Pages 10-15
Benefits of a Trail	Pages 16-19
Interpretive Opportunities	Pages 20-25
TRAIL ROUTE RECOMMENDATIONS	Pages 26-85
Overview Map	Page 27
Types of Trails	Pages 28-29
Detail Maps	Pages 30-65
DESIGN RECOMMENDATIONS	Pages 66- 75
Signage and Wayfinding	Page 67
Sign Types	Pages 68-69
Trail Environments	Pages 70-71
Trailheads	Page 72
Public Art, Fencing, and Lighting	Page 73
Road Crossings	Pages 74-75
TRAIL MANAGEMENT	Pages 76-77
NEXT STEPS	Pages 78-79
GRANTS AND FUNDING	Pages 80-83
APPENDIX	
Appendix A: Survey Results	Pages I-XII
Appendix B: Community Workshops Summary	Pages XIII-XXVI
Appendix C: Oregon Parks and Recreation Grants List	Pages XXVII-XXX

ABOUT THIS DOCUMENT

Umatilla County, in partnership with the National Park Service (NPS) Rivers, Trails, and Conservation Assistance (RTCA) program, have been working collaboratively with local community members, user-groups, land owners and management agencies to develop a vision and plan for a multi-modal trail that interconnects the cities of Umatilla, Hermiston, Stanfield and Echo. The Umatilla River Trail Plan provides information on the community process and recommendations for a new trail. It also provides information on overall benefits, uses, types of trails and amenities. It represents the community's collective-conceptual vision for the trail, and is a culmination of all the hard work, vision, partnerships, and collaboration that has gone into this project.

The Umatilla River Trail Concept Plan is intended to provide an overall vision, alignment, and general recommendations for the Umatilla River Trail. It does not go into specific detail about exact locations of the trail on public property, number of amenities provided, or contain engineered drawings. It is meant to illustrate what route [and potential alternatives] may look like as it is developed over time. After reading this plan, one should have a general idea of the character of the trail, a preferred alignment with suggested alternative routes, and where trailheads and potential amenities may be located. Before the trail is built, detailed construction documents will need to be generated, specifying exact locations, measurements, and materiality. Phased implementation, adaptive management, funding, and partnership building is expected to continue over time to best suit the needs of the trail, users, members of the public, and the environment.



View of the Umatilla River as seen from Nugent Park Trail (City of Umatilla)



VISION

A trail system that inter-connects Umatilla, **Hermiston, Stanfield, and Echo** to increase recreation and community livability.



MISSION

- To create a community supported trails plan to guide development of a Umatilla River trail system
- To increase coordination, collaboration and partnerships between Umatilla County, West County communities, trail stakeholders and supporters
- To support the county Plan4Health Initiative's goal to improve citizen health and wellness by providing the physical infrastructure to support active living
- To develop recommendations for funding implementation of the trails plan and maintenance of the trails
- To guide adoption of plan recommendations into county and community comprehensive and transportation system plans

GOALS

- Provide access to recreation opportunities for walking, bicycling, horseback riding, mountain biking, nature viewing, kayaking, fishing and other activities
- Create an interconnected trail system that supports choices for safe, active, non-motorized transportation
- Connect community business districts and neighborhoods with the Umatilla and Columbia Rivers, parks and other regional trails
- Enhance community health and well-being by providing more opportunities for citizens to get outside and be physically active
- Provide educational opportunities and information that highlights regional and community historical, cultural, and natural resources
- Boost local tourism and economic development by becoming a regional trail destination

INTRODUCTION

Project Area

Demographics

Health Profile

Vision, Mission,
and Goals

Planning Process

Benefits of a
Community Trail

Interpretive
Opportunities

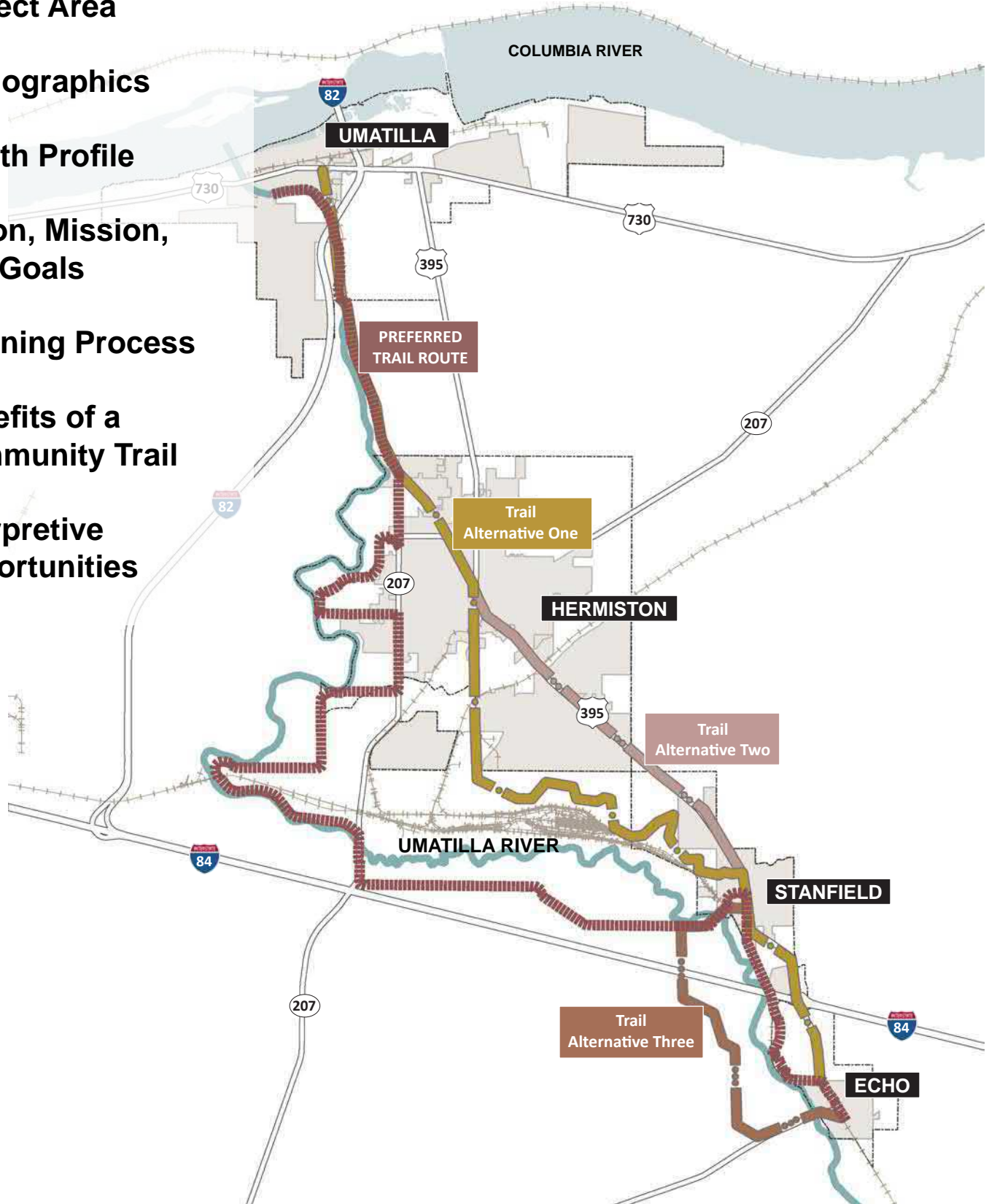

TRAIL ROUTE AND RECOMMENDATIONS

Overview Map

Types of Trails

**Detail Maps and
Trail Recommendations**



The Umatilla River as seen from Nugent Park Trail (City of Umatilla).

OVERVIEW MAP

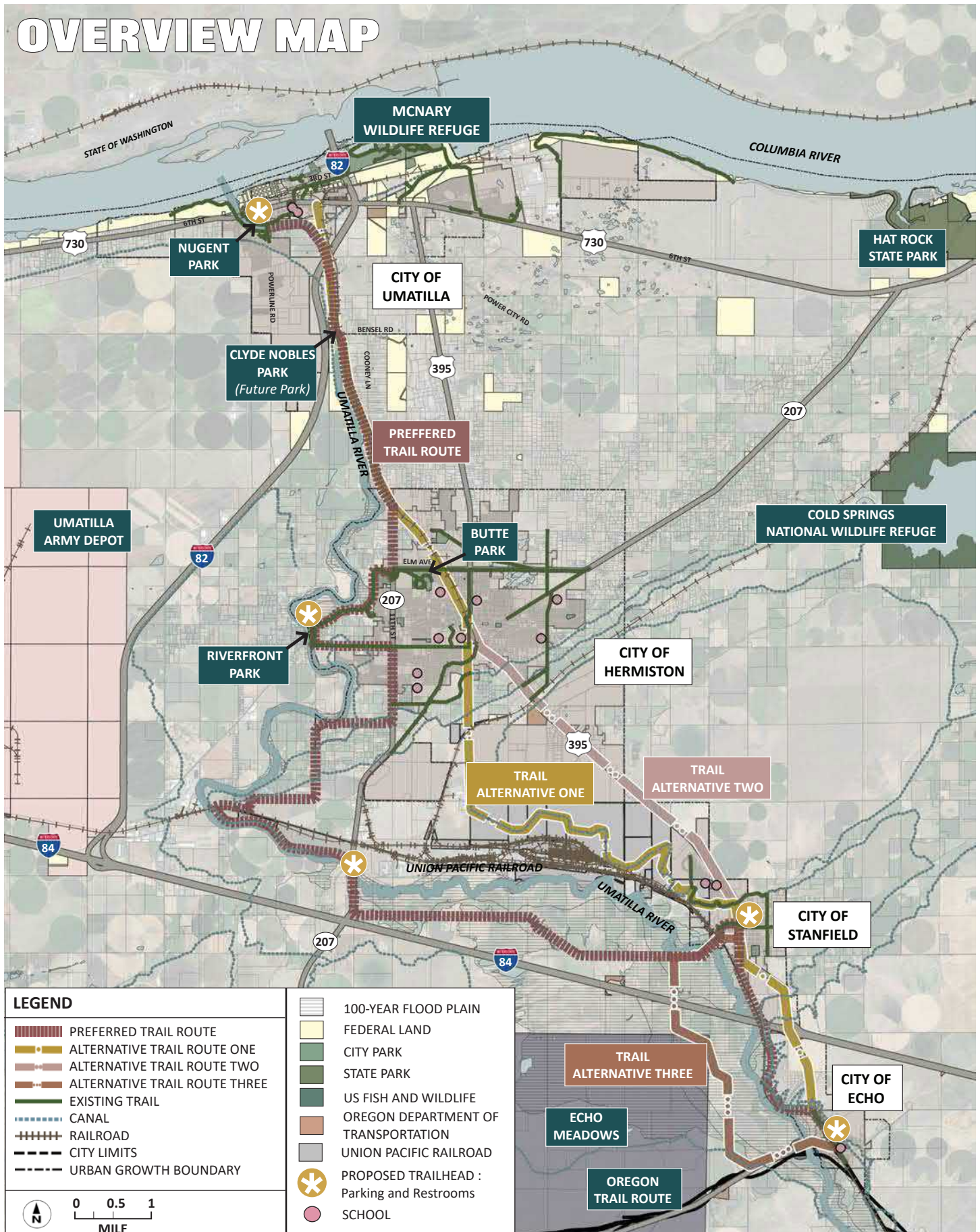

DETAIL ONE



DETAIL ONE

ROUTES AND RECOMMENDATIONS

PREFERRED ROUTE

- 1 City of Umatilla Nugent Park Trailhead**

Nugent Park serves as an ideal location for the City of Umatilla trailhead. The park has adequate parking and easy access to the Umatilla River. It is also located in close proximity to Umatilla's schools, residential neighborhoods and the downtown core. An existing paved trail extends south from Nugent Park to a city owned pedestrian bridge. However, repairs are needed after the trail experienced significant damage during the 2019 and 2020 flood events.
- 2 Umatilla Pedestrian Bridge**

Prior to flood events in 2019 and 2020, a pedestrian footbridge connected Nugent Park with Umatilla's "south hill" neighborhood. The City of Umatilla is in the process of seeking grant funding to assist with replacement of the structure.
- 3 USACE Land**

Approximately 22 acres of public land managed by the United States Army Corps of Engineers (USACE) is located along this section of the Umatilla River. Planning for a public trail in this area will require a Federal environmental permitting process. Project stakeholders should work with the city and county, in coordination with USACE staff, for proper planning and design.
- 4 Nobles Property (private land)**

Land in this area is privately-owned by local community member, Kelly Nobles. Mr. Nobles has been actively involved on the steering committee for this project as well as the development of other recreation facilities in the community. Mr. Nobles is supportive of using a portion of his property for a public trail. Project stakeholders, City of Umatilla, and county staff should work closely with Mr. Nobles to possibly establish a public recreation easement for a trail located on the property adjacent to the Umatilla River.
- 5 I-82 Crossing**

Interstate-82 (I-82) crosses the Umatilla River at this location. Stakeholders should coordinate the planning and design of the trail in this area with Oregon Department of Transportation, who manages the I-82 right-of-way.
- 6 Private Land (Recreation Easement Required)**

Land in this area is privately owned. Coordination with the underlying landowner in this area will be necessary.

DETAIL ONE [CONTINUED]



DETAIL ONE [CONTINUED]

ROUTES AND RECOMMENDATIONS

ALTERNATIVE ROUTE ONE

A Downtown Umatilla (Highway 730 and River Road Intersection)

Alternative One begins at the intersection of State Highway 730 and River Road. Project stakeholders should work with the city and county, in coordination with ODOT staff, for proper planning and design of a trail system in this area. More analysis may be necessary to determine if the area is suitable for a trailhead.

B River Road / Union Pacific Railroad Right-of-Way

River Road is a 60 foot wide public right-of-way managed by the County. The road is immediately adjacent to an infrequently-utilized rail line operated by Union Pacific. A trail in this area, between the road and rail line would offer users with nice views of the Umatilla River. Since the trail would be located adjacent to a rail line, the right-of-way is unobstructed and slopes are gentle, meaning permitting and engineering may be simpler than locating the trail immediately adjacent to the river. Working with Umatilla County Public Works and Union Pacific, trail planning for this segment of the trail will need to determine the best type of trail infrastructure (i.e. a paved, separated pathway within the right-of-way, or an attached, paved lane along the shoulder of the road).

C Interstate-82 Crossing over River Road

Interstate-82 (I-82) crosses the River Road and the Union Pacific rail line at this location. Stakeholders should coordinate the planning and design of the trail in this area with Oregon Department of Transportation, who manages the I-82 right-of-way.



Where Life is Sweet

City of
Hermiston, Oregon



City of
Umatilla, Oregon



Umatilla County, Oregon

Preliminary Engineering Report

UMATILLA RIVER BRIDGE

2022



engineering • surveying • natural resources

LA GRANDE, OR. WALLA WALLA, WA. REDMOND, OR. HERMISTON, OR.

1901 N. Fir Street - La Grande, Oregon 97850

(541) 963-8309

www.andersonperry.com

**UMATILLA RIVER BRIDGE
PRELIMINARY ENGINEERING REPORT**

FOR

**CITY OF HERMISTON, OREGON
CITY OF UMATILLA, OREGON
UMATILLA COUNTY, OREGON**

2022



ANDERSON PERRY & ASSOCIATES, INC.

**La Grande, Redmond, and Hermiston, Oregon
Walla Walla, Washington**

Table of Contents

Executive Summary	ES-1
A. Introduction.....	ES-1
B. Transportation System	ES-1
C. Land Use and Acquisition	ES-2
D. Permitting, Environmental, and Cultural Resources	ES-2
E. General Consensus and Project Implementation.....	ES-3
Chapter 1 - Introduction and Background	1-1
A. Introduction.....	1-1
B. Historical Background.....	1-1
C. Demand for Umatilla River Bridge.....	1-1
D. Summary.....	1-2
Chapter 2 - Transportation Impact Analysis	2-1
A. Introduction.....	2-1
B. Data Collection Summary	2-1
C. Existing Traffic Conditions	2-2
D. Projected Traffic Conditions	2-2
No-Build Condition (2032 Projection).....	2-2
Punkin Center Road Option (2032 Projection)	2-3
Elm Avenue Option (2032 Projection)	2-3
E. Summary.....	2-4
Chapter 3 - Transportation System Improvements	3-1
A. Overview.....	3-1
Ordinary High Water.....	3-1
Federal Emergency Management Agency Floodplain and Floodway.....	3-1
B. Elm Avenue Option.....	3-2
Bridge Structure	3-2
Roadway Improvements	3-3
C. Punkin Center Road Option.....	3-5
Bridge Structure	3-5
Roadway Improvements	3-6
D. Summary.....	3-9
Chapter 4 - Land Use and Acquisition	4-1
A. Overview.....	4-1
B. Elm Avenue Option.....	4-1
Land and Right-of-Way Acquisition	4-1
Land Use (Zoning)	4-2
C. Punkin Center Road Option.....	4-3
Land and Right-of-Way Acquisition	4-3
Land Use (Zoning)	4-3
D. Summary.....	4-4

Chapter 5 - Permitting, Environmental, and Cultural Resources	5-1
A. Overview.....	5-1
B. Elm Avenue Option.....	5-1
Goal 5 Resource Mapping.....	5-1
Wetlands and Waterways.....	5-2
Floodplains.....	5-3
Soils and Farmland.....	5-3
Protected Species	5-3
Migratory Birds	5-4
Land Use/Zoning	5-5
Stormwater Discharge	5-5
Parks, Green Spaces, and Natural Areas.....	5-5
Noise and Air Quality	5-5
Hazardous Materials.....	5-5
Cultural Resources and Historic Properties	5-7
Funding Requirements.....	5-8
Advantages.....	5-8
Disadvantages.....	5-8
Permits.....	5-8
Cost	5-9
C. Punkin Center Road Option.....	5-10
Goal 5 Resource Mapping.....	5-10
Wetlands and Waterways.....	5-11
Floodplains.....	5-11
Soils and Farmland.....	5-12
Protected Species	5-12
Migratory Birds	5-13
Land Use/Zoning	5-13
Stormwater Discharge	5-14
Parks, Green Spaces, and Natural Areas.....	5-14
Noise and Air Quality	5-14
Hazardous Materials.....	5-14
Cultural Resources and Historic Properties	5-15
Funding Requirements.....	5-15
Advantages.....	5-15
Disadvantages.....	5-16
Permits.....	5-16
Cost	5-17
Chapter 6 - Preferred Option and Project Implementation	6-1
A. Preferred Option	6-1
B. Project Implementation	6-2
Chapter 7 - References	7-1

TABLES

Table 2-1 Transportation Analysis Summary 2-5
Table 3-1 Transportation System Improvements Summary 3-10
Table 4-1 Land Use and Acquisition Summary¹ 4-4
Table 5-1 Soils Found within the Elm Avenue Option..... 5-3
Table 5-2 Elm Avenue Option Environmental Permits 5-8
Table 5-3 Elm Avenue Option Environmental Costs 5-9
Table 5-4 Soils Found within the Punkin Center Road Option..... 5-12
Table 5-5 Punkin Center Road Option Environmental Permits..... 5-16
Table 5-6 Punkin Center Road Option Environmental Costs 5-17
Table 5-7 Advantages and Disadvantages..... 5-18

FIGURES

Figure 1-1 Location and Vicinity Maps
Figure 1-2 Aerial Photograph
Figure 3-1 River Crossing Plan and Profile Elm Avenue Option
Figure 3-2 River Crossing Plan and Profile Punkin Center Road Option
Figure 4-1A-D Tax Lot Map Elm Avenue Option
Figure 4-2A-C Tax Lot Map Punkin Center Road Option
Figure 4-3 Elm Avenue Option Right-of-Way Acquisition Cost
Figure 4-4 Punkin Center Road Option Right-of-Way Acquisition Cost
Figure 4-5A City of Hermiston Zoning
Figure 4-5B Umatilla County Zoning
Figure 4-5C Comprehensive Land Use Map
Figure 5-1 Critical Groundwater Areas
Figure 5-2 Wetlands and Waterways
Figure 5-3 Soils Map
Figure 5-4 Protected Species
Figure 5-5 Existing Park System
Figure 5-6 DEQ Permitted Sites

APPENDICES

Appendix A - New East-West Roadway Circulation Analysis Technical Memo by Kittelson & Associates, Inc.
Appendix B - City of Hermiston, Oregon, Urban Major Arterial Cross Sections
Appendix C - Cost Estimates for Infrastructure Improvements and Land Acquisition
Appendix D - Memorandum of Understanding

Executive Summary

A. Introduction

This Executive Summary briefly presents the results of the Umatilla River Bridge Preliminary Engineering Report (PER) prepared by Anderson Perry & Associates, Inc., for the City of Hermiston, Oregon, in partnership with the City of Umatilla and Umatilla County. The findings outlined herein have been developed in cooperation with each of these three benefitting jurisdictions. The focus of this PER is to compare two potential locations for a bridge crossing the Umatilla River. The two locations considered are at W. Punkin Center Road and W. Elm Avenue. This PER includes a high-level analysis of the existing transportation system and how the construction of a bridge would affect the system. This PER discusses recommended improvements to the transportation system based on the traffic analysis and bridge location and provides high-level project cost estimates for each project necessitated by bridge construction for comparison purposes. Additionally, it includes a discussion of the impacts to land use and acquisition and explores environmental, permitting, and cultural resource requirements and recommendations. This Executive Summary includes a brief discussion of the transportation system analysis; recommended improvements to the transportation system; and permitting, environmental, and cultural resource requirements. This PER also includes a summary of the bridge location selected by the benefitting jurisdictions as a result of this PER. For a more detailed discussion of the information presented in this Executive Summary, refer to the individual chapters of this PER.

The benefitting jurisdictions recognize the need for this PER, as installation of an additional bridge over the Umatilla River has been included in the City of Hermiston's Transportation System Plan (TSP) since 1997. Hermiston's TSP has never identified which of the two proposed locations is the best option. This PER will act as a guide to enable the benefitting jurisdictions to ultimately select the most appropriate location for the Umatilla River Bridge.

B. Transportation System

Because constructing a new bridge across the Umatilla River will significantly impact traffic flow conditions, a transportation system analysis was conducted by Kittelson & Associates, Inc. Four scenarios were analyzed, including existing traffic conditions, projected traffic conditions in the future with no bridge constructed, projected traffic conditions in the future with a bridge constructed in line with W. Elm Avenue, and projected traffic conditions in the future with a bridge constructed in line with W. Punkin Center Road. The travel corridors are depicted on Figures 4-1A through 4-1D and 4-2A through 4-2C in Chapter 4. The Interstate 82 interchange on Powerline Road and U.S. 395 is at the end of the travel corridors and is generally excluded from the scope of this PER. The analysis found that future conditions would exceed the capacity of much of the existing infrastructure. Improvements recommended in this PER include turning lanes, traffic signals, new sections of roadway, and the bridge structure itself. Furthermore, infrastructure improvements necessitate the acquisition of additional right-of-way (ROW). Total estimated project costs, including ROW acquisition, construction, engineering fees, contingencies, etc., for the various improvements discussed in this PER total approximately \$48.82 million for the Elm Avenue option and approximately \$43.6 million for the Punkin Center Road option. These costs do not include costs associated with permitting, environmental, and cultural resource requirements.

C. Land Use and Acquisition

A new bridge across the Umatilla River would fundamentally change traffic patterns and future land use. ROW acquisition would be needed to enable construction of the recommended improvements. Estimated costs discussed above include ROW acquisition and are based on properties' real market values. The recommended ROW width of the travel corridor was assumed to be 90 feet. Figures 4-1A through 4-1D and 4-2A through 4-2C in Chapter 4 show ROW acquisition locations for properties adjacent to potential future travel corridors.

Properties adjacent to each potential travel corridor have various zoning designations. Zoning designations encompass the zones identified by the City of Hermiston, City of Hermiston Comprehensive Use Plan, and Umatilla County. In Chapter 4, Figure 4-5A, City of Hermiston Zoning, shows the zoning designations of the land within city limits; Figure 4-5B, Umatilla County Zoning, shows the zoning designations of the land outside city limits and the urban growth boundary (UGB); and Figure 4-5C, Comprehensive Land Use Map, shows the zoning designations of the land outside of city limits but within the UGB. Each potential bridge location would provide access to the west side of the river and has substantial potential to encourage development along the new travel corridor. Much of the new travel corridor would pass through what is now mostly rural farmland. To further encourage development, land use and zoning designations would need to be modified to allow for more urbanized land use types such as commercial, industrial, and residential. The Elm Avenue option would provide a more direct path to the heart of the City of Hermiston, which could be advantageous for connectivity, but would come at the cost of significantly increased traffic. Although connectivity to the city center would not be directly achieved with the Punkin Center Road option, this option would generally provide more favorable traffic conditions than the Elm Avenue option.

D. Permitting, Environmental, and Cultural Resources

New bridge construction, to some extent, will impact local natural resources as defined and discussed in Goal 5 of Umatilla County's Comprehensive Land Use Plan. Goal 5 resources include riparian corridors, wetlands, wildlife habitat, and cultural areas. A new bridge is anticipated to impact wetlands, waterways, floodplains, and farmland. Endangered Species Act-listed species occur within the project corridor options. A new bridge would result in new impervious surfaces. Two parks, Butte Park, which is funded by the Land and Water Conservation Fund, and the disc golf course, are located adjacent to the Elm Avenue option. Several Oregon Department of Environmental Quality permitted sites are located adjacent to the project corridor options, resulting in a chance of contaminated soils being encountered during construction. A Bureau of Land Management (BLM)-owned natural area is located adjacent to the Punkin Center Road option.

Estimated costs for potential permits and environmental clearances that could be required for the new bridge total \$574,000 for the Elm Avenue option and \$624,000 for the Punkin Center Road option. The funding agency will determine which environmental permits and consultation will be required for the proposed project. If federal funding is utilized, an Environmental Assessment will be required. Since a portion of the Punkin Center Road option corridor occurs on BLM-owned land, the project may be subject to BLM National Environmental Policy Act requirements and an extensive environmental review process.

E. General Consensus and Project Implementation

At a meeting held on August 2, 2022, representatives from the City of Hermiston, City of Umatilla, and Umatilla County reached a general consensus that the Punkin Center Road option is the preferred option while also indicating that the Elm Avenue option is both viable and still under consideration. In addition to being slightly less expensive, the Punkin Center Road option is considered more favorable for the following reasons:

- Fundamentally changes regional traffic patterns
- Provides a more direct connection to Interstate 82
- Causes significantly less traffic congestion at critical intersections than the Elm Avenue option
- More closely reflects preferred urban growth boundary expansion
- Encourages increased economic potential due to nearby properties along the travel corridor being less parcelized.
- Provides a direct route to the hospital from the City of Umatilla

The City of Umatilla and Umatilla County are currently working on revising their TSPs, and the City of Hermiston plans to revise theirs in the near future. This PER should be referenced in each TSP. A Memorandum of Understanding has been drafted and signed by each of the benefitting jurisdictions (see Appendix D), indicating the current preference of the Punkin Center Road option.

Chapter 1 - Introduction and Background

A. Introduction

The purpose of this Preliminary Engineering Report is to identify and compare the strengths, weaknesses, requirements, high-level planning costs, and implications for constructing a bridge across the Umatilla River in one of two locations. Because inflation is currently unpredictable, all estimated costs are given for the year 2022. Inflation will need to be accounted for depending on the year the bridge is constructed. The two bridge crossing locations considered are at W. Elm Avenue and W. Punkin Center Road. See Figure 1-1 for the location and vicinity maps and Figure 1-2 for an aerial view of the potential project locations. The two bridge options were chosen based on the City of Hermiston's Transportation System Plan (TSP), which identified these locations for potential bridge options. A specific option was not selected in the TSP likely because there was not enough information readily available at the time to make an informed decision. This document will aid all benefitting jurisdictions involved in making an informed decision when selecting a bridge option.

B. Historical Background

In 1985 the U.S. Congress passed a law that created the Chemical Stockpile Emergency Preparedness Program (CSEPP) and directed the Army to dispose of stored aging chemical weapons. This was done with the protection of the public and environment as its primary objective. Federal funding through the CSEPP was available for projects related to stored chemical weapons at the Umatilla Army Depot, approximately 4 miles west of Hermiston. A bridge across the Umatilla River was originally proposed as an emergency evacuation route sometime during the 1990s. The proposal was ultimately not supported by the CSEPP, and a bridge was not constructed at that time. Although construction did not occur during that period, the two bridge options were adopted as part of Hermiston's original TSP in 1997. Although low on the priority list in the 1997 TSP, a bridge across the Umatilla River has become increasingly important as time has passed and urban growth has continued.

C. Demand for Umatilla River Bridge

Although not immediately necessary, the forecasted urban growth within Umatilla County has made apparent the need to plan for an additional bridge across the Umatilla River in the future. As part of this planning, it is prudent that one of the two options for the bridge location be selected well in advance of actual project initiation. Although a time frame for bridge construction is difficult to determine, local officials estimate that bridge construction will not occur until at least the year 2032. Selecting the location this far in advance will enable local officials to make informed decisions about growth and development in Umatilla County.

The City of Hermiston anticipates that their urban growth boundary will eventually include sections of land west of the Umatilla River. A second bridge spanning the Umatilla River would reduce the likelihood of bottlenecks at the current bridge location where Bridge Road becomes West Highland Avenue and would favorably alter local traffic conditions in the City of Hermiston and Umatilla County. The second bridge would also encourage growth on the west side of the Umatilla River. Because growth, especially urban growth, is usually associated with strong economic conditions, growth on the west side of the Umatilla River would benefit both Umatilla County and the City of Hermiston.

Adding a bridge crossing over the Umatilla River would be beneficial to the City of Umatilla because it would encourage further growth, especially at the south end of the City. Many City of Umatilla residents work, shop, recreate, and generally use the amenities available in Hermiston. A bridge would provide another travel route between the two cities that would likely be more direct and lead to decreased travel time. In addition to enabling and promoting growth on the west side of the Umatilla River and in the City of Umatilla, the bridge would also help alleviate current traffic congestion on U.S. 395 and N. 1st Place. Mitigating traffic congestion on U.S. 395 and N. 1st Place is in the best interest of Umatilla County, the City of Umatilla, and the City of Hermiston because it would increase safety and allow better traffic conditions for local residents.

D. Summary

This planning document presents information needed to make a more informed decision on which of the two proposed bridge locations is most appropriate. A bridge crossing the Umatilla River has been discussed since the CSEPP began funding projects in the area, and the need for a bridge has become increasingly important. Selecting a bridge location will help local jurisdictions plan for growth and development. Benefits of the bridge include, but are not limited to, promoting growth in the City of Hermiston, the City of Umatilla, and Umatilla County; decreasing traffic congestion; and increasing traffic safety.

VL55VR6gisprojects\hermiston\736-123 UmatillaRiverBridge\736-123 UmatillaRiverBridge\736-123 LocVic. 6/23/2022 8:12 AM dchristman

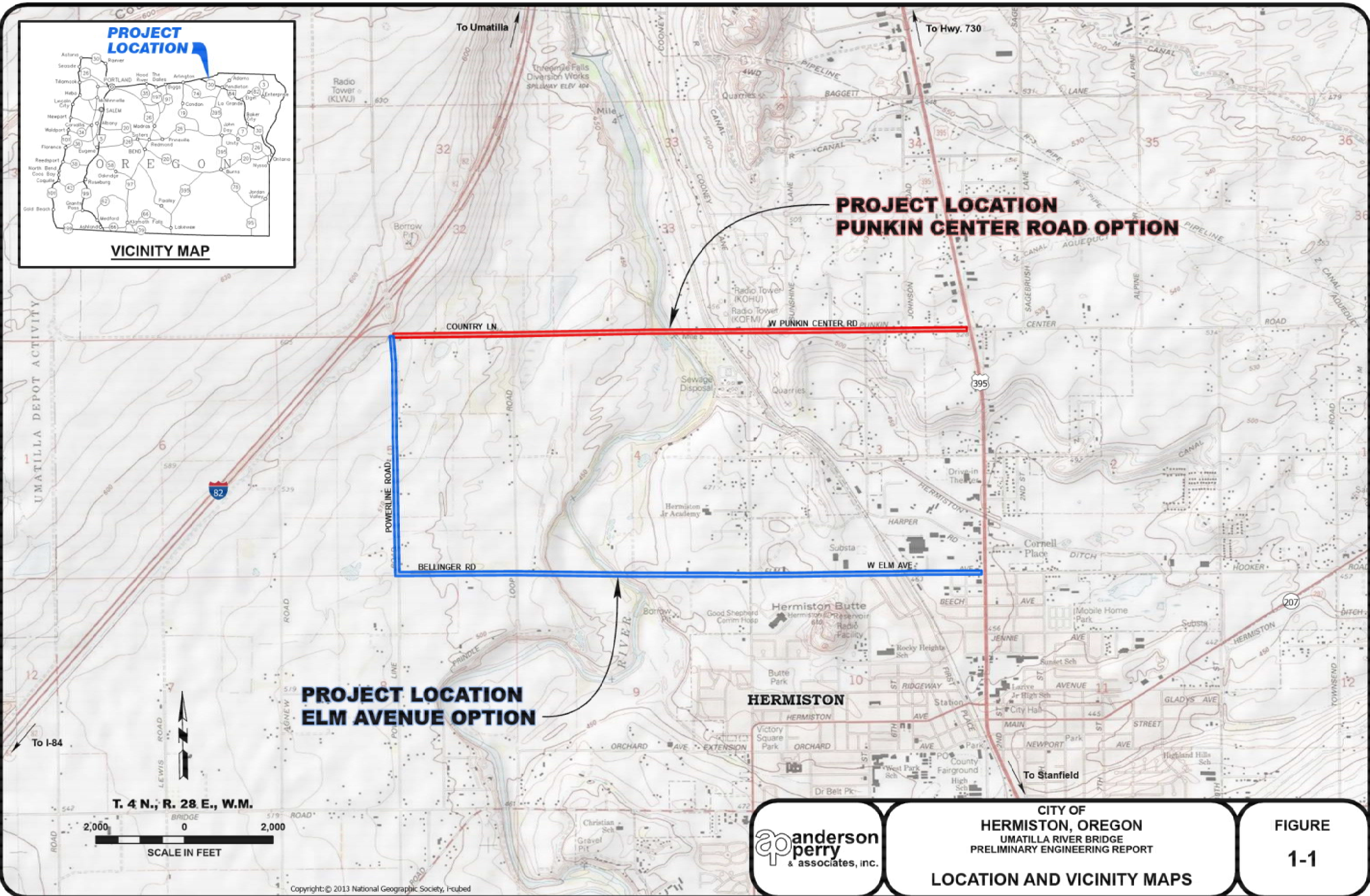
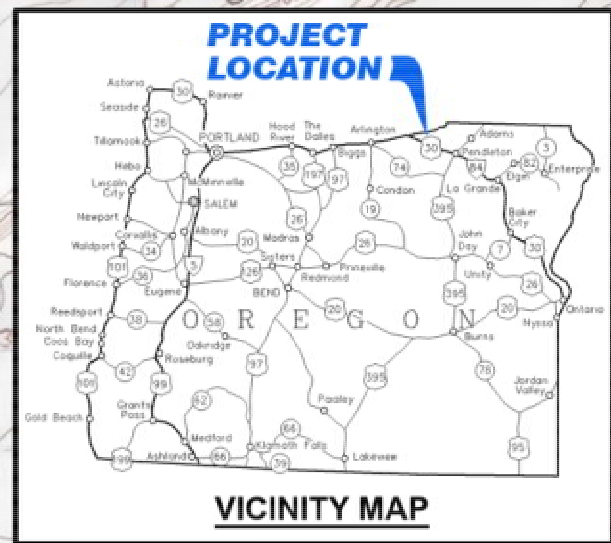

**CITY OF
HERMISTON, OREGON**
UMATILLA RIVER BRIDGE
PRELIMINARY ENGINEERING REPORT

LOCATION AND VICINITY MAPS

**FIGURE
1-1**

Appendix B
Pavement Data

Umatilla Transportation Plan

Existing Pavement Condition Inventory (May 2022)

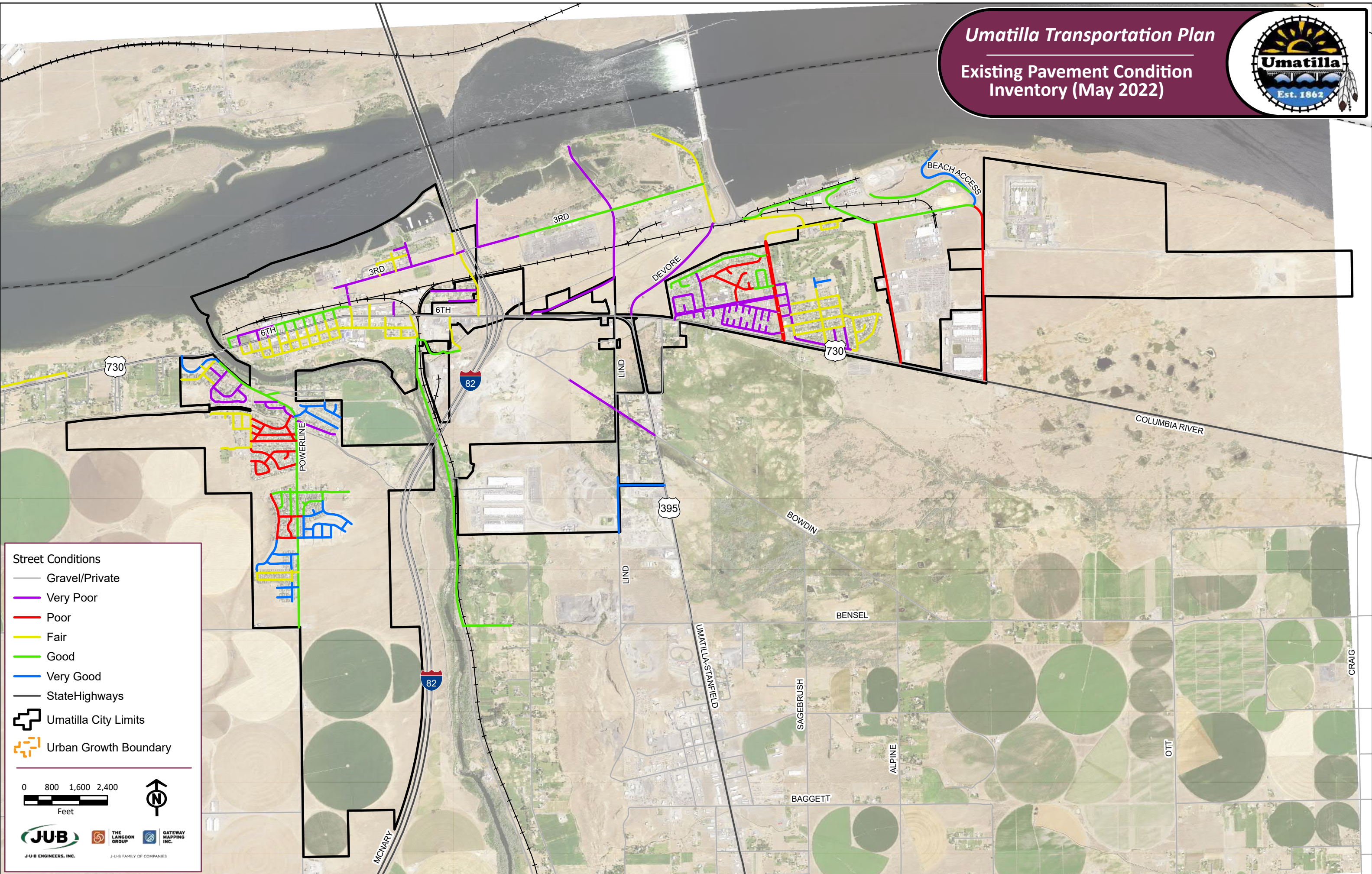

Street Conditions

- Gravel/Private
- Very Poor
- Poor
- Fair
- Good
- Very Good
- State Highways
- Umatilla City Limits
- Urban Growth Boundary

0 800 1,600 2,400 Feet

JUB J-U-B ENGINEERS, INC.
THE LANGDON GROUP
GATEWAY MAPPING INC.
J-U-B FAMILY OF COMPANIES

Street Conditions

- Gravel/Private
- Very Poor
- Poor
- Fair
- Good
- Very Good

 Umatilla City Limits

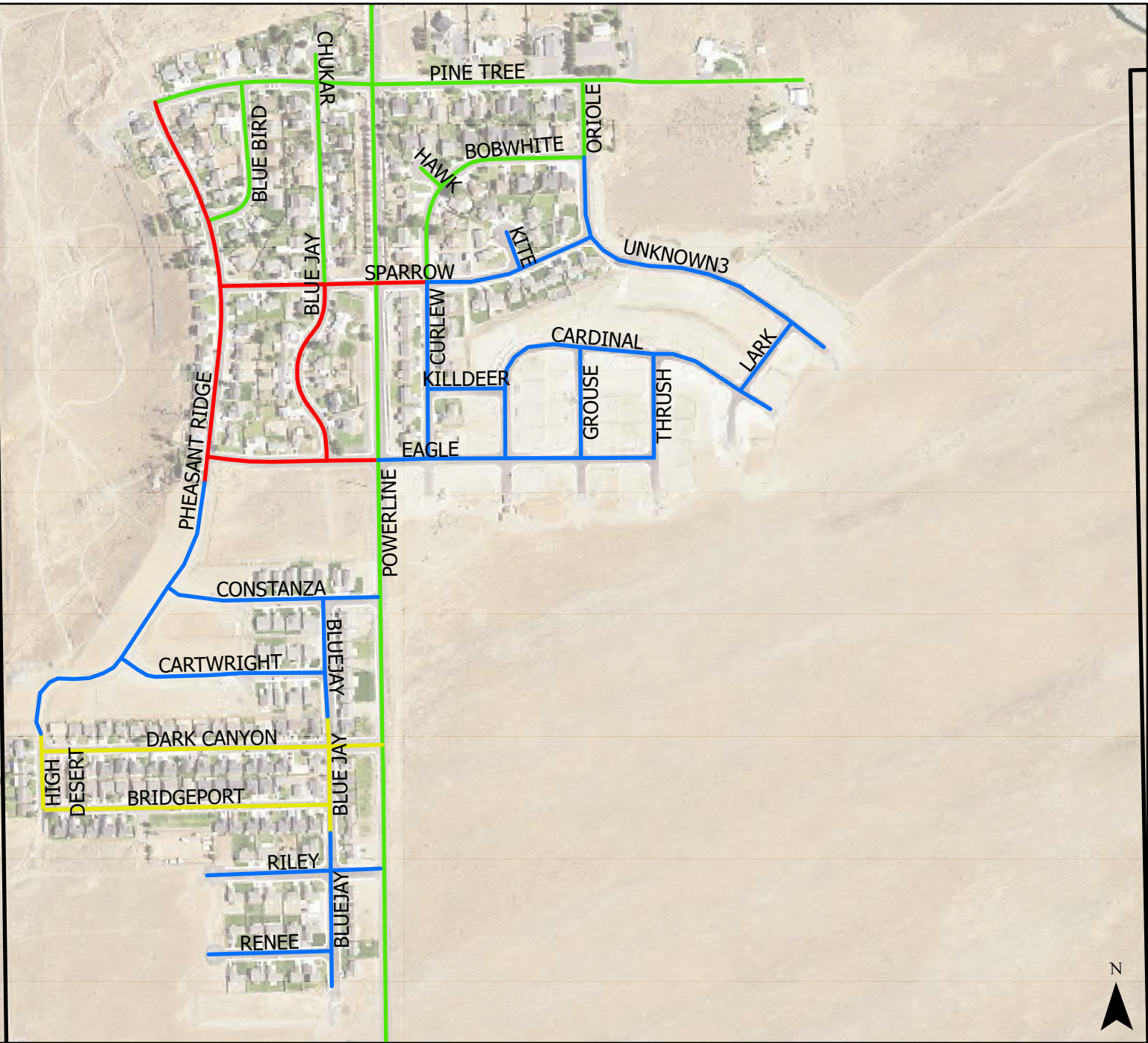

EXISTING PAVEMENT CONDITION

ZONE
1

UMATILLA TRANSPORTATION
SYSTEM PLAN UMATILLA, OR

\\KWKFILES\Public\Clients\OR\Umatilla\City\Projects\07-22-008_-_Transportation\SystemPlan\GIS\DistressTypes\Basmear-DistressTypes.aprx

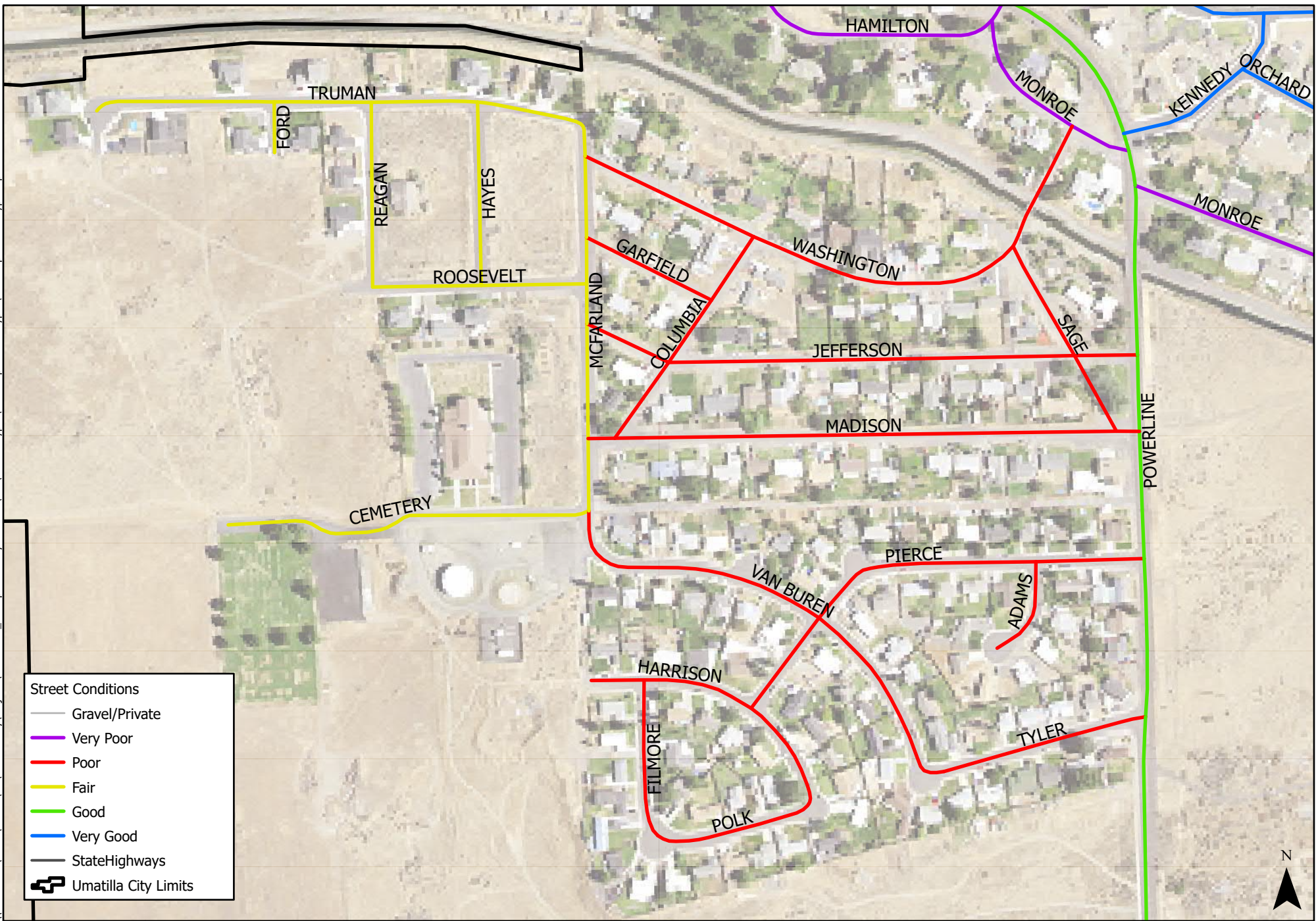

EXISTING PAVEMENT CONDITION

ZONE
2

UMATILLA TRANSPORTATION
SYSTEM PLAN UMATILLA, OR

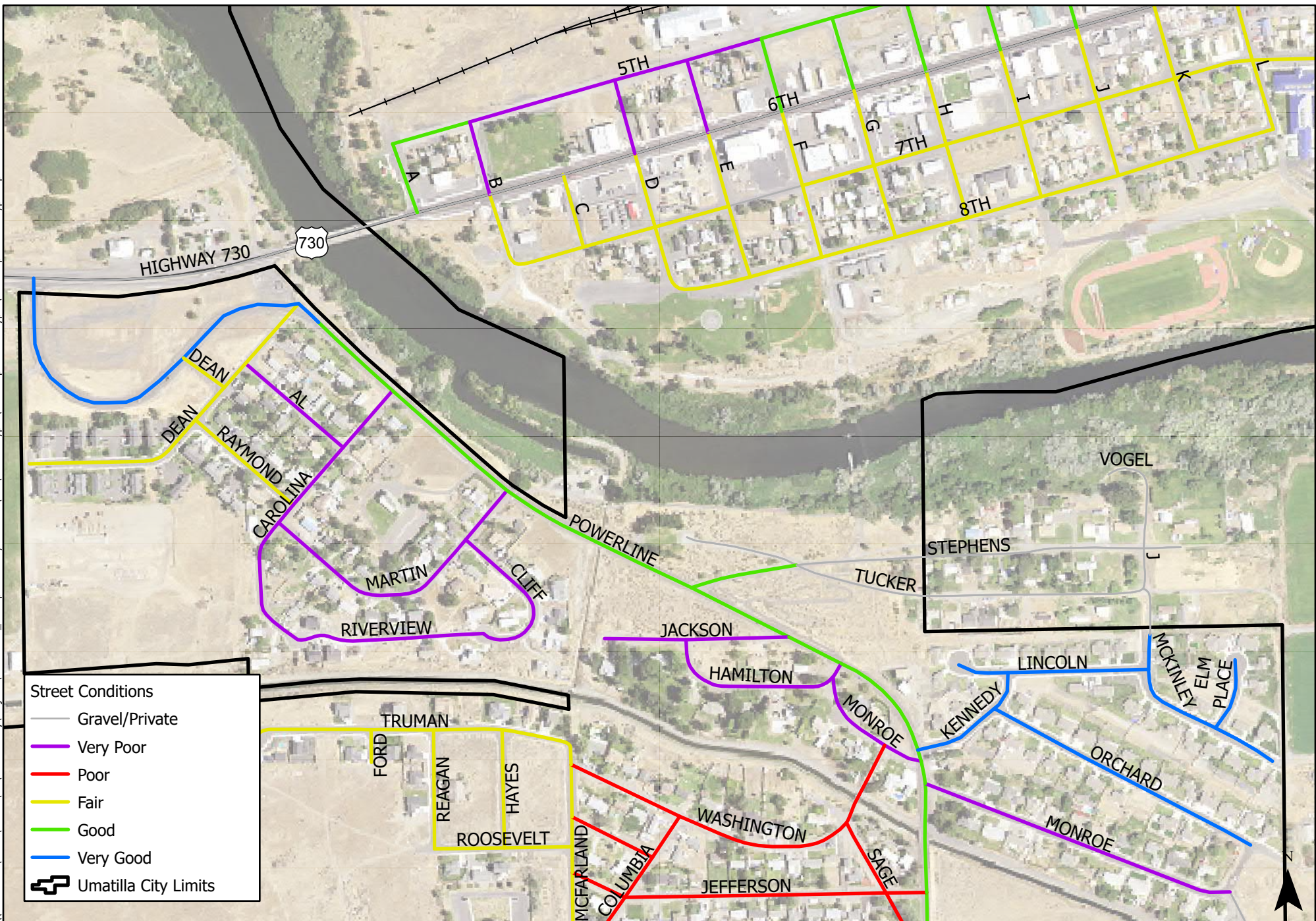

EXISTING PAVEMENT CONDITION

ZONE
3

UMATILLA TRANSPORTATION
SYSTEM PLAN UMATILLA, OR

\\W\K\FILES\Public\Clients\OR\Umatilla\City\Projects\07-22-008...Transportation\SystemPlan\GIS\DistressTypes\Basmearp-DistressTypes.aprx

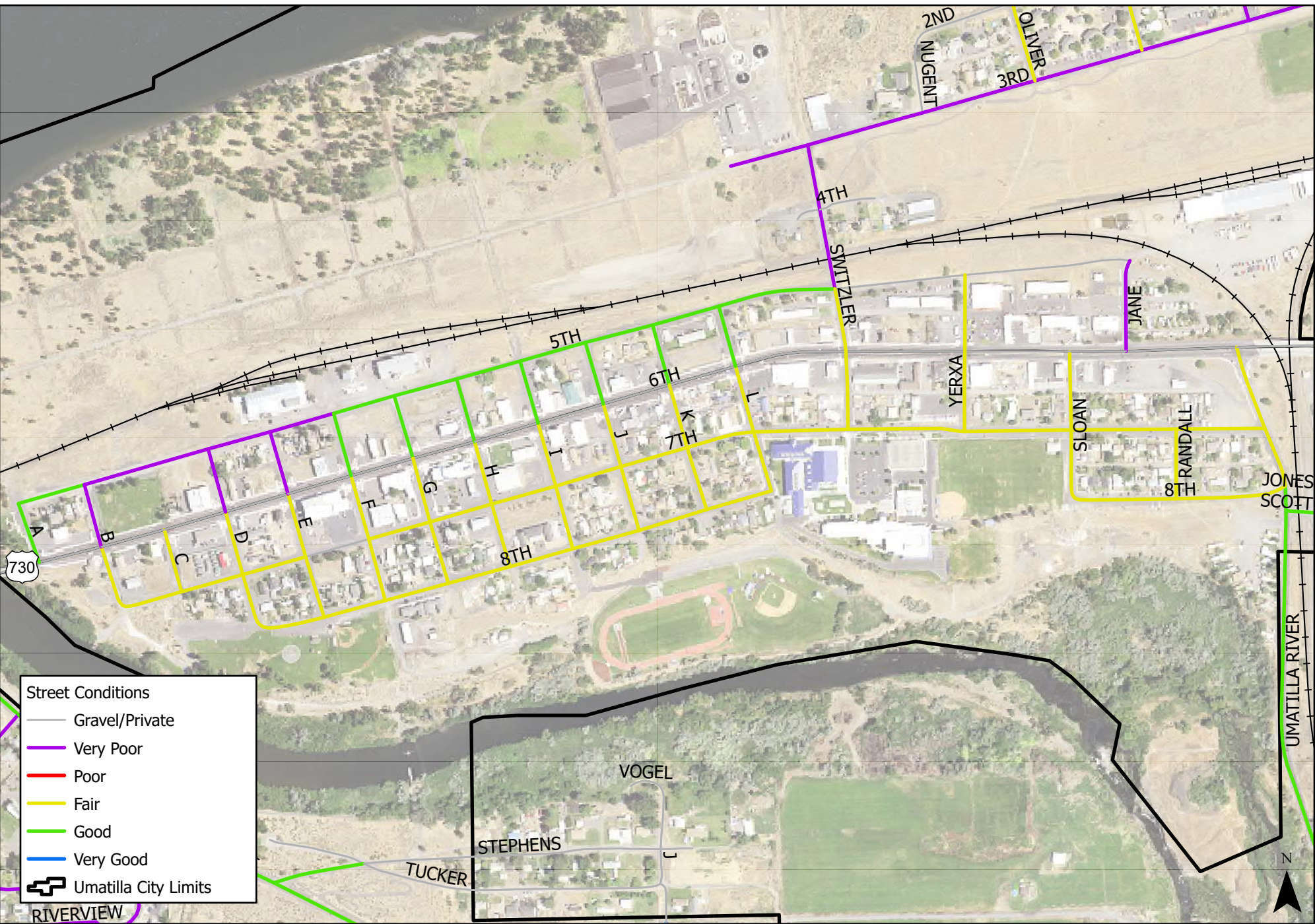

Street Conditions

- Gravel/Private
- Very Poor
- Poor
- Fair
- Good
- Very Good
- Umatilla City Limits



EXISTING PAVEMENT CONDITION

ZONE
4 & 5

UMATILLA TRANSPORTATION
SYSTEM PLAN UMATILLA, OR

\\KWKFILES\Public\Clients\OR\UmatillaCity\Projects\07-22-008_-_Transportation\SystemPlan\GIS\DistressTypes\Basmearp-DistressTypes.aprx

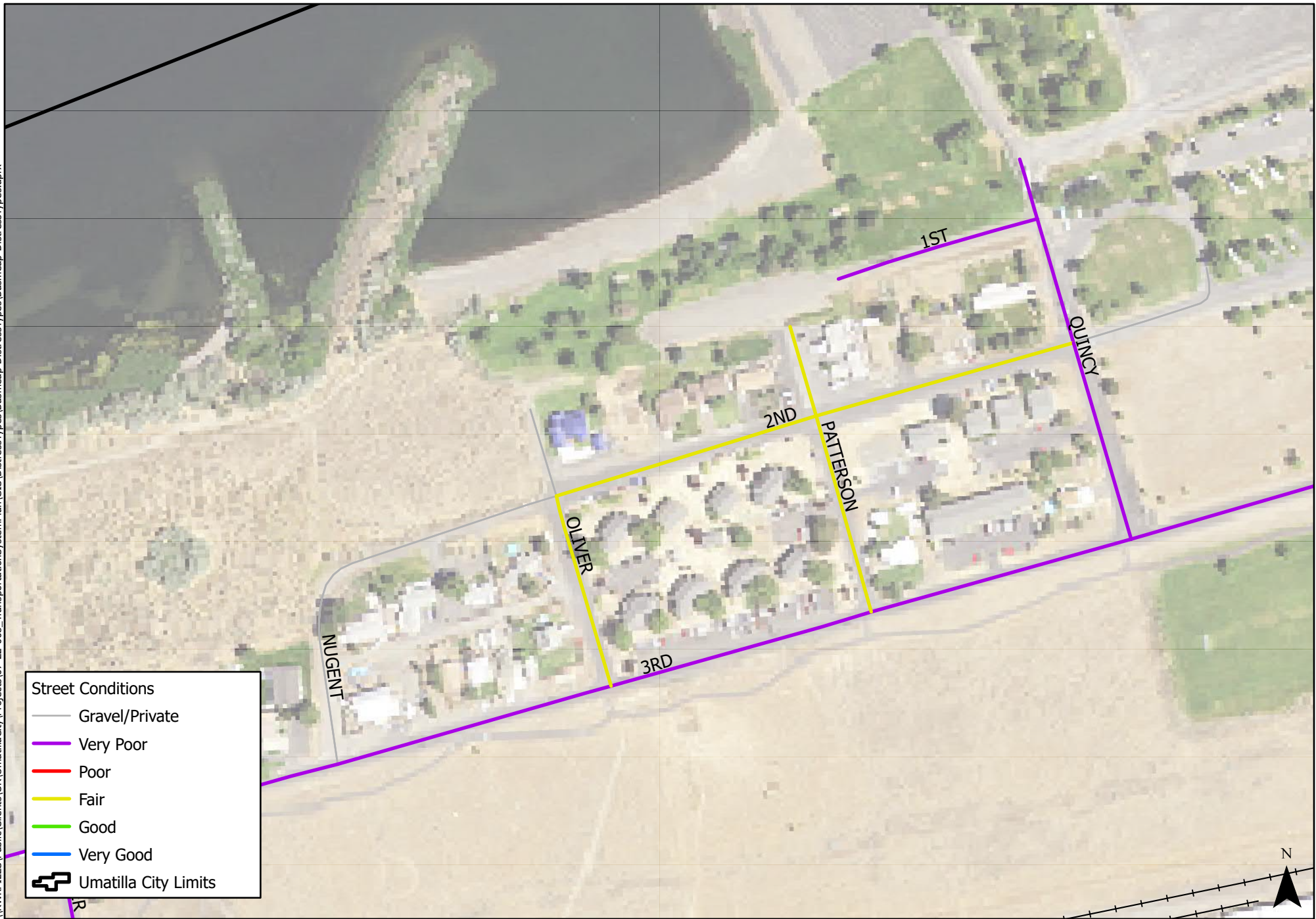

Street Conditions

- Gravel/Private
- Very Poor
- Poor
- Fair
- Good
- Very Good
- Umatilla City Limits



EXISTING PAVEMENT CONDITION

ZONE
6

UMATILLA TRANSPORTATION
SYSTEM PLAN UMATILLA, OR

\\KWKFILES\Public\Clients\OR\Umatilla\City\Projects\07-22-008_-_Transportation\SystemPlan\GIS\DistressTypes\Basmear-DistressTypes.aprx

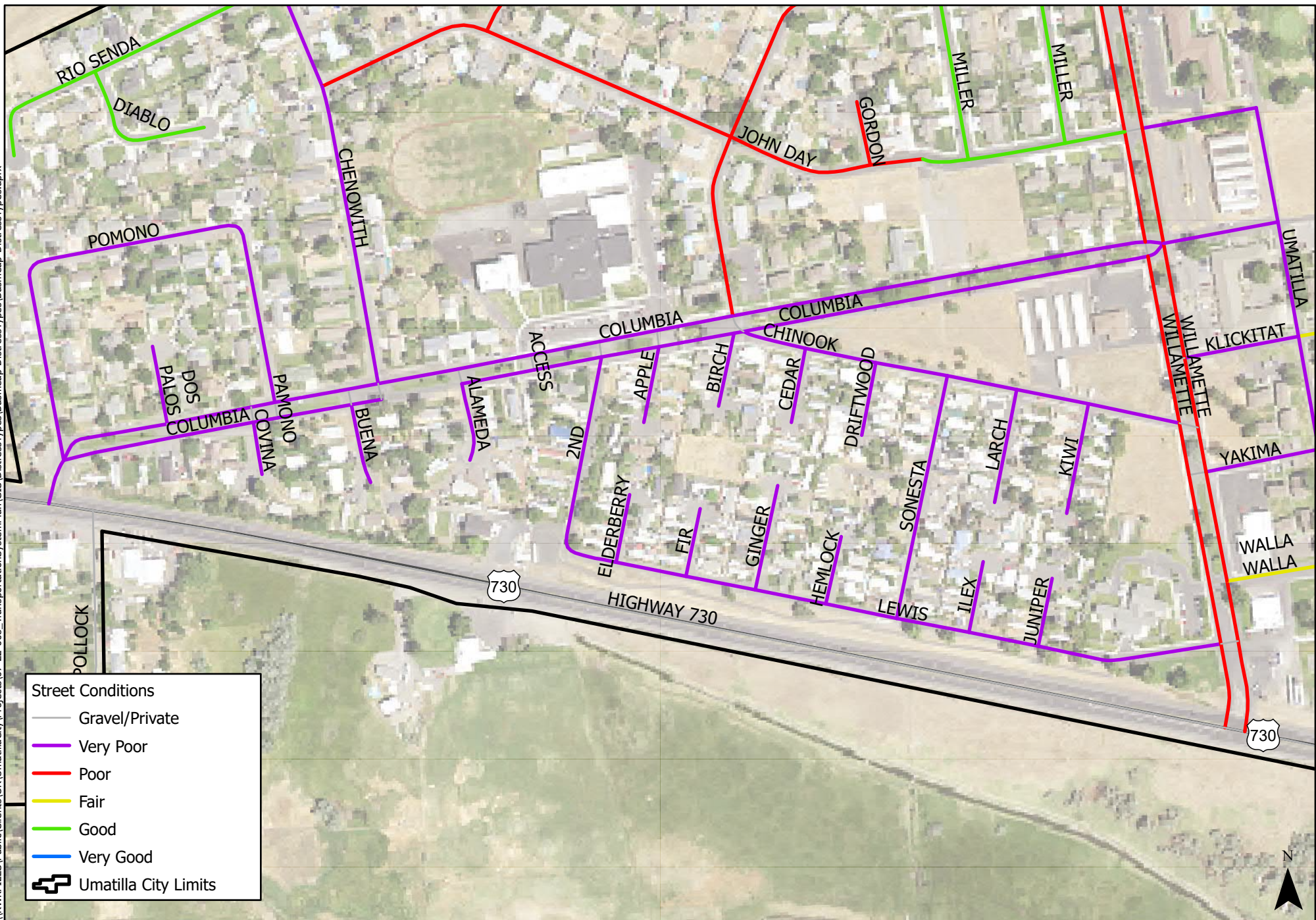

EXISTING PAVEMENT CONDITION

ZONE
7

UMATILLA TRANSPORTATION
SYSTEM PLAN UMATILLA, OR

\\KWKFILES\Public\Clients\OR\UmatillaCity\Projects\07-22-008_Transportation\SystemPlan\GIS\DistressTypes\Basmear-DistressTypes.aprx

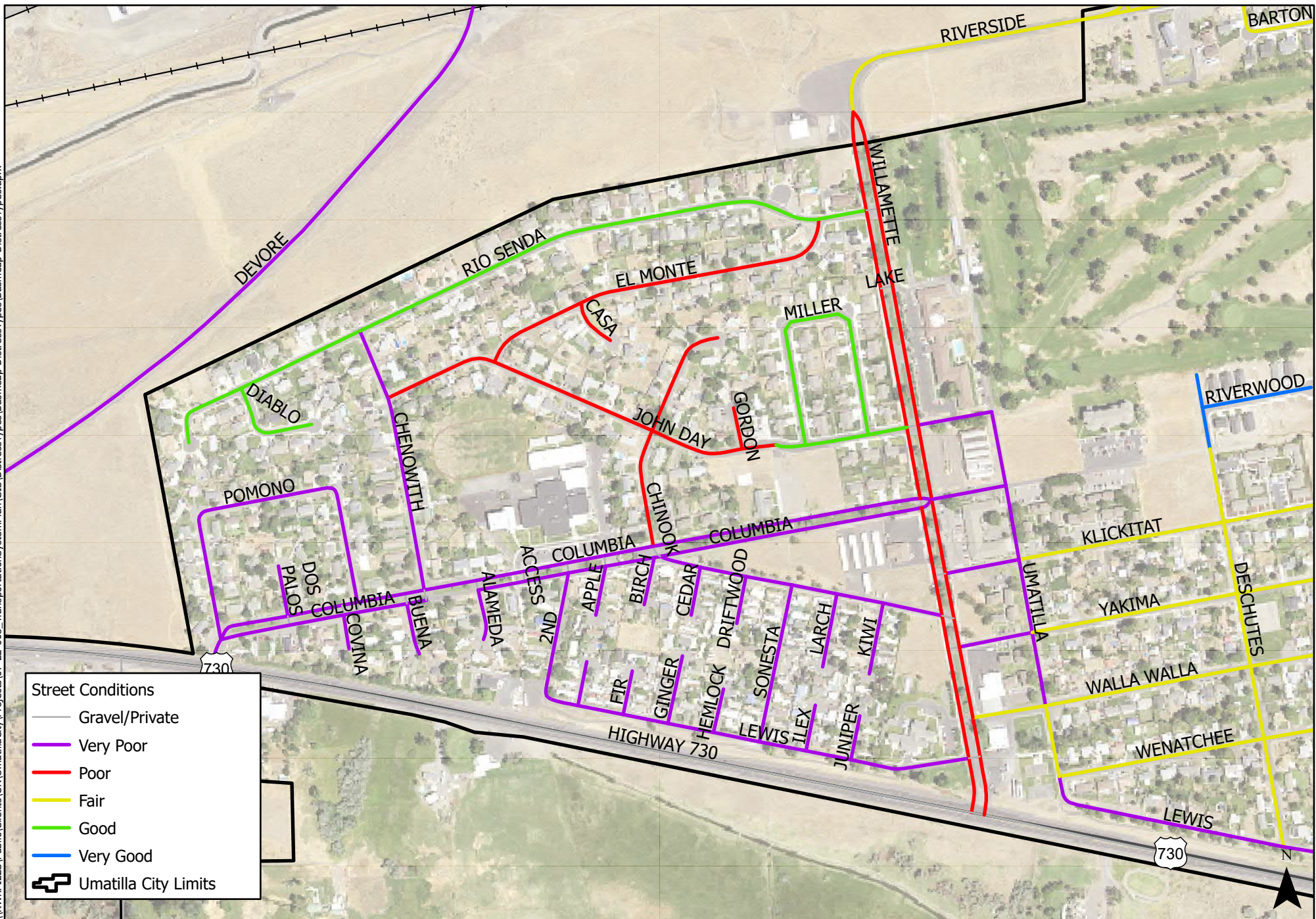

EXISTING PAVEMENT CONDITION

ZONE 8

UMATILLA TRANSPORTATION SYSTEM PLAN UMATILLA, OR

\\KWKFILES\Public\Clients\OR\Umatilla\City\Projects\07-22-008...Transportation\SystemPlan\GIS\DistressTypes\Basmear-DistressTypes.aprx

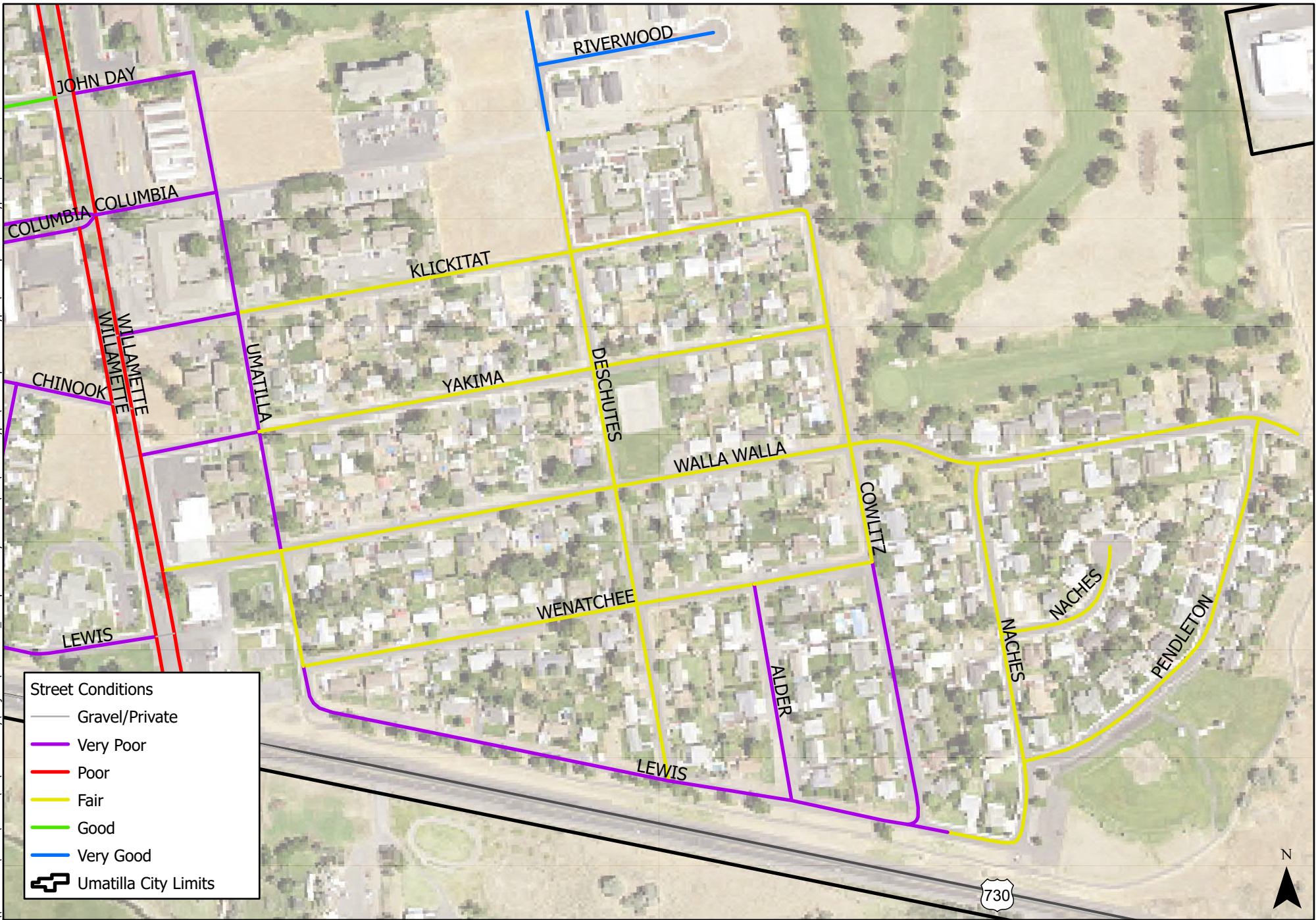

Street Conditions

- Gravel/Private
- Very Poor
- Poor
- Fair
- Good
- Very Good
- Umatilla City Limits

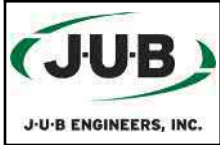

EXISTING PAVEMENT CONDITION

ZONE
9

UMATILLA TRANSPORTATION
SYSTEM PLAN UMATILLA, OR

					Fatigue Cracking (LF per 0.1 Mile, by Severity Level)				Longitudinal Cracking (LF per 0.1 Mile, by Severity Level)				Transverse Cracking (Number per 0.1 Mile, by Severity Level)				Patches (SF per 0.1 Mile, by Severity Level)				Potholes (Number per 0.1 Mile, by Severity Level)				Raveling (LF per 0.1 Mile, by Severity Level)				Bleeding (Y/N)	
ID #	NAME	LENGTH (MI)	Overall Index	Overall Rating	Low	Moderate	High	Composite Index	Low	Moderate	High	Composite Index	Low	Moderate	High	Composite Index	Low	Moderate	High	Composite Index	Low	Moderate	High	Composite Index	Low	Moderate	High	Composite Index	Yes/No	Composite Index
1	1ST ST	0.51	13.49	VERY POOR	0	0	0	1.0000	0	0	528	0.9167	0	0	64	0.1472	0	0	0	1.0000	0	0	0	1.0000	0	0	0	1.0000	NO	1.0000
2	2ND AVE	0.10	20.62	VERY POOR	0	60	0	0.4397	0	31	554	0.9170	0	13	30	0.5151	0	0	0	1.0000	0	0	0	1.0000	4	0	0	0.9929	NO	1.0000
3	2ND ST	0.64	76.77	FAIR	57	0	0	0.9014	0	0	0	1.0000	7	8	1	0.8517	0	0	0	1.0000	0	0	0	1.0000	0	0	0	1.0000	NO	1.0000
4	3RD ST (EAST TO DAM)	0.50	3.22	VERY POOR	0	2112	0	0.2000	0	0	0	1.0000	0	0	30	0.4161	684	495	0	0.5188	2	11	0	0.3869	0	0	0	1.0000	NO	1.0000
5	3RD ST (SUB TO SCAPLEHORN)	0.57	86.53	GOOD	0	0	0	1.0000	78	0	0	0.9959	5	6	0	0.8689	0	0	0	1.0000	0	0	0	1.0000	0	0	0	1.0000	NO	1.0000
6	3RD ST (I82 TO SUBSTATION)	0.30	5.19	VERY POOR	0	668	0	0.2870	0	210	0	0.9779	0	11	34	0.4727	0	0	0	1.0000	2	7	3	0.3909	0	0	0	1.0000	NO	1.0000
7	3RD ST (W OF I82)	0.70	6.68	VERY POOR	164	850	0	0.3126	320	0	200	0.9775	4	15	24	0.6059	0	0	0	1.0000	0	0	1	0.3609	0	0	0	1.0000	NO	1.0000
8	4TH ST	0.07	GRAVEL	GRAVEL				1.0000				1.0000				1.0000				1.0000				1.0000				1.0000	NO	1.0000
9	5TH ST (E)	0.42	83.72	GOOD	46	0	0	1.0000	11	0	0	0.9994	20	6	0	0.8377	0	0	0	1.0000	0	0	0	1.0000	0	0	0	1.0000	NO	1.0000
10	5TH ST (W)	0.26	13.93	VERY POOR	137	528	32	0.3525	0	571	542	0.9276	0	0	29	0.4259	0	0	0	1.0000	0	0	0	1.0000	0	0	0	1.0000	NO	1.0000
11	7TH ST	0.95	60.11	FAIR	324	0	0	0.7650	99	0	0	0.9948	18	13	0	0.8050	0	0	0	1.0000	0	0	0	1.0000	28	0	0	0.9812	NO	1.0000
12	8TH ST	0.60	60.11	FAIR	324	0	0	0.7650	99	0	0	0.9948	18	13	0	0.8050	0	0	0	1.0000	0	0	0	1.0000	28	0	0	0.9812	NO	1.0000
13	A ST	0.26	83.72	GOOD	46	0	0	1.0000	11	0	0	0.9994	20	6	0	0.8377	0	0	0	1.0000	0	0	0	1.0000	0	0	0	1.0000	NO	1.0000
14	ADAMS CT	0.05	28.26	POOR	444	0	106	0.4427	100	100	78	0.9909	3	4	18	0.6442	0	0	0	1.0000	0	0	0	1.0000	0	0	0	1.0000	NO	1.0000
15	AL ST	0.09	2.02	VERY POOR	0	1318	0	0.2368	0	0	120	0.9811	0	0	30	0.4161	0	0	20	0.4754	0	0	2	0.3151	0	1584	0	0.6636	NO	1.0000
16	ALAMEDA CT	0.05	13.35	VERY POOR	51	0	5	0.5747	13	256	522	0.9369	0	14	20	0.6100	0	0	0	1.0000	0	1	1	0.4248	150	0	0	0.9565	NO	1.0000
17	ALDER AVE	0.10	6.13	VERY POOR	0	2112	0	0.2000	0	0	0	1.0000	0	0	0	1.0000	0	10	270	0.3298	0	4	6	0.3064	0	0	0	1.0000	NO	1.0000
18	APPLE CT	0.05	20.62	VERY POOR	0	60	0	0.4397	0	31	554	0.9170	0	13	30	0.5151	0	0	0	1.0000	0	0	0	1.0000	4	0	0	0.9929	NO	1.0000
19	APRICOT LN	0.26	GRAVEL	GRAVEL				1.0000				1.0000				1.0000				1.0000				1.0000				1.0000	NO	1.0000
20	B ST (N)	0.05	13.93	VERY POOR	137	528	32	0.3525	0	571	542	0.9276	0	0	29	0.4259	0	0	0	1.0000	0	0	0	1.0000	0	0	0	1.0000	NO	1.0000
21	B ST (S)	0.05	60.11	FAIR	324	0	0	0.7650	99	0	0	0.9948	18	13	0	0.8050	0	0	0	1.0000	0	0	0	1.0000	28	0	0	0.9812	NO	1.0000
22	BARTON LOOP	0.16	75.03	FAIR	0	0	0	1.0000	32	98	0	0.9918	7	18	0	0.7565	0	0	0	1.0000	0	0	0	1.0000	0	0	0	1.0000	NO	1.0000
23	BEACH ACCESS RD	1.53	47.19	POOR	259	0	0	0.7899	0	10	0	0.9989	12	1	0	0.8810	18	0	0	0.7145	0	0	0	1.0000	0	0	0	1.0000	YES	0.9500
24	BENSEL RD	0.77	82.51	GOOD	0	0	0	1.0000	277	0	0	0.9854	21	0	0	0.8373	0	0	0	1.0000	0	0	0	1.0000	0	0	0	1.0000	NO	1.0000
25	BIRCH CT	0.04	20.62	VERY POOR	0	60	0	0.4397	0	31	554	0.9170	0	13	30	0.5151	0	0	0	1.0000	0	0	0	1.0000	4	0	0	0.9929	NO	1.0000
26	BLUE BIRD DR	0.11	83.91	GOOD	0	0	0	1.0000	419	0	0	0.9779	16	0	0	0.8580	0	0	0	1.0000	0	0	0	1.0000	0	0	0	1.0000	NO	1.0000
27	BLUE JAY ST (N OF SPARROW)	0.12	83.91	GOOD	0	0	0	1.0000	419	0	0	0.9779	16	0	0	0.8580	0	0	0	1.0000	0	0	0	1.0000	0	0	0	1.0000	NO	1.0000
28	BLUE JAY ST (SPARROW TO EAGLE)	0.12	42.67	POOR	37	25	0	0.5541	528	0	0	0.9722	21	13	6	0.7921	0	0	0	1.0000	0	0	0	1.0000	0	0	0	1.0000	NO	1.0000
29	BLUE JAY ST (S)	0.26	77.07	FAIR	0	0	0	1.0000	45	48	0	0.9962	7	16	0	0.7736	0	0	0	1.0000	0	0	0	1.0000	0	0	0	1.0000	NO	1.0000
30	BOBWHITE AVE	0.10	83.91	GOOD	0	0	0	1.0000	419	0	0	0.9779	16	0	0	0.8580	0	0	0	1.0000	0	0	0	1.0000	0	0	0	1.0000	NO	1.0000
31	BONNEY LN	0.36	GRAVEL	GRAVEL				1.0000				1.0000				1.0000				1.0000				1.0000				1.0000	NO	1.0000
32	BOWDIN LN	0.97	GRAVEL	GRAVEL				1.0000				1.0000				1.0000				1.0000				1.0000				1.0000	NO	1.0000
33	BRIDGEPORT AVE	0.19	77.07	FAIR	0	0	0	1.0000	45	48	0	0.9962	7	16	0	0.7736	0	0	0	1.0000	0	0	0	1.0000	0	0	0	1.0000	NO	1.0000
34	BROWNELL BLVD	0.63	58.59	FAIR	425	0	0	0.7308	15	0	0	0.9992	31	0	0	0.8024	0	0	0	1.0000	0	0	0	1.0000	0	0	0	1.0000	NO	1.0000
35	BUCKS LN	0.06	GRAVEL	GRAVEL				1.0000				1.0000				1.0000				1.0000				1.0000				1.0000	NO	1.0000
36	BUD DRAPER DR	0.41	90.99	GOOD	35	0	0	1.0000	220	0	0	0.9884	5	0	0	0.9206	0	0	0	1.0000	0	0	0	1.0000	0	0	0	1.0000	NO	1.0000
37	BUD DRAPER RD (CONCRETE)	0.78	33.70	POOR																										
38	BUELL LN	0.12	GRAVEL	GRAVEL				1.0000				1.0000				1.0000				1.0000				1.0000				1.0000	NO	1.0000
39	BUENA CT	0.05	13.35	VERY POOR	51	0	5	0.5747	13	256	522	0.9369	0	14	20	0.6100	0	0	0	1.0000	0	1	1	0.4248	150	0	0	0.9565	NO	1.0000
40	C ST	0.16	60.11	FAIR	324	0	0	0.7650	99	0	0	0.9948	18	13	0	0.8050	0	0	0	1.0000	0	0	0	1.0000	28	0	0	0.9812	NO	1.0000
41	CANAL DR	0.29	GRAVEL	GRAVEL				1.0000				1.0000				1.0000				1.0000				1.0000				1.0000	NO	1.0000
42	CARDINAL PL	0.25	100.00	VERY GOOD	0	0	0	1.0000	0	0	0	1.0000	0	0	0	1.0000	0	0	0	1.0000	0	0	0	1.0000	0	0	0	1.0000	NO	1.0000
43	CAROLINA RD	0.22	3.05	VERY POOR	0	1318	0	0.2368	0	0	120	0.9811	0	0	30	0.4161	0	0	20	0.4754	0	0	0	1.0000	0	1584	0	0.6636	NO	1.0000
44	CARTWRIGHT	0.14	100.00	VERY GOOD	0	0	0	1.0000	0	0	0	1.0000	0	0	0	1.0000	0	0	0	1.0000	0	0	0	1.0000	0	0	0	1.0000	NO	1.0000
45	CASA CT	0.08	39.78	POOR	400	0	0	0.7389	0	597	205	0.9450	0	30	21	0.5698	0	0	0	1.0000	0	0	0	1.0000	0	0	0	1.0000	NO	1.0000
46	CEDAR CT	0.04	20.62	VERY POOR	0	60	0	0.4397	0	31	554	0.9170	0	13	30	0.5151	0	0	0	1.0000	0	0	0	1.0000	4	0	0	0.9929	NO	1.0000
47	CHENOWITH AVE	0.22	13.35	VERY POOR	51	0	5	0.5747	13	256	522	0.9369	0	14	20	0.6100	0	0	0	1.0000	0	1	1	0.4248	150	0	0	0.9565	NO	1.0000
48	CHERRY ST	0.26	1.83	VERY POOR	0	528	0	0.3036	85	0	0	0.9955	0	10	0	0.7752	0	0	115	0.3751	0	0	10	0.1955	0	0	3168	0.4000	NO	1.0000
49	CHINOOK AVE	0.33	20.62	VERY POOR	0	60	0	0.4397	0	31	554	0.9170	0	13	30	0.5151	0	0	0	1.0000	0	0	0	1.0000	4	0	0	0.9929	NO	1.0000
50	CHINOOK CT	0.09	39.78	POOR	400	0	0	0.7389	0	597	205	0.9450	0	30	21	0.5698	0	0	0	1.0000	0	0	0	1.0000	0	0	0	1.0000	NO	1.0000
51	CHUKAR CIR	0.02	83.91	GOOD	0	0	0	1.0000	419	0	0	0.9779	16																	

57	COPPER LN	0.18	GRAVEL	GRAVEL			1.0000				1.0000				1.0000				1.0000				1.0000			1.0000	NO	1.0000		
58	COVINA CT	0.03	13.35	VERY POOR	51	0	5	0.5747	13	256	522	0.9369	0	14	20	0.6100	0	0	0	1.0000	0	1	1	0.4248	150	0	0	0.9565	NO	1.0000
59	COWLITZ AVE	0.30	72.27	FAIR	0	0	0	1.0000	139	0	0	0.9927	6	22	2	0.7280	0	0	0	1.0000	0	0	0	1.0000	0	0	0	1.0000	NO	1.0000
60	CURLEW ST (N/S)	0.18	100.00	VERY GOOD	0	0	0	1.0000	0	0	0	1.0000	0	0	0	1.0000	0	0	0	1.0000	0	0	0	1.0000	0	0	0	1.0000	NO	1.0000
61	CURLEW ST	0.18	100.00	VERY GOOD	0	0	0	1.0000	0	0	0	1.0000	0	0	0	1.0000	0	0	0	1.0000	0	0	0	1.0000	0	0	0	1.0000	NO	1.0000
62	D ST (N)	0.05	13.93	VERY POOR	137	528	32	0.3525	0	571	542	0.9276	0	0	29	0.4259	0	0	0	1.0000	0	0	0	1.0000	0	0	0	1.0000	NO	1.0000
63	D ST (S)	0.10	60.11	FAIR	324	0	0	0.7650	99	0	0	0.9948	18	13	0	0.8050	0	0	0	1.0000	0	0	0	1.0000	28	0	0	0.9812	NO	1.0000
64	DARK CANYON AVE	0.22	77.07	FAIR	0	0	0	1.0000	45	48	0	0.9962	7	16	0	0.7736	0	0	0	1.0000	0	0	0	1.0000	0	0	0	1.0000	NO	1.0000
65	DEAN AVE	0.24	63.28	FAIR	71	0	0	0.8900	0	381	0	0.9600	7	4	13	0.7407	0	0	0	1.0000	0	0	0	1.0000	0	0	0	1.0000	NO	1.0000
66	DESCHUTES AVE	0.54	64.07	FAIR	0	0	0	1.0000	164	218	260	0.9734	6	10	20	0.6582	0	0	0	1.0000	0	0	0	1.0000	0	0	0	1.0000	NO	1.0000
67	DESCHUTES ST	0.35	72.27	FAIR	0	0	0	1.0000	139	0	0	0.9927	6	22	2	0.7280	0	0	0	1.0000	0	0	0	1.0000	0	0	0	1.0000	NO	1.0000
68	DEVORE RD	1.35	3.22	VERY POOR	0	2112	0	0.2000	0	0	0	1.0000	0	0	30	0.4161	684	495	0	0.5188	2	11	0	0.3869	0	0	0	1.0000	NO	1.0000
69	DIABLO CT	0.08	78.70	GOOD	0	0	0	1.0000	446	0	0	0.9765	17	13	0	0.8060	0	0	0	1.0000	0	0	0	1.0000	0	0	0	1.0000	NO	1.0000
70	DOS PALOS CT	0.05	13.35	VERY POOR	51	0	5	0.5747	13	256	522	0.9369	0	14	20	0.6100	0	0	0	1.0000	0	1	1	0.4248	150	0	0	0.9565	NO	1.0000
71	DRIFTWOOD CT	0.04	20.62	VERY POOR	0	60	0	0.4397	0	31	554	0.9170	0	13	30	0.5151	0	0	0	1.0000	0	0	0	1.0000	4	0	0	0.9929	NO	1.0000
72	E ST (N)	0.05	13.93	VERY POOR	137	528	32	0.3525	0	571	542	0.9276	0	0	29	0.4259	0	0	0	1.0000	0	0	0	1.0000	0	0	0	1.0000	NO	1.0000
73	E ST (S)	0.10	60.11	FAIR	324	0	0	0.7650	99	0	0	0.9948	18	13	0	0.8050	0	0	0	1.0000	0	0	0	1.0000	28	0	0	0.9812	NO	1.0000
74	EAGLE AVE (E)	0.18	100.00	VERY GOOD	0	0	0	1.0000	0	0	0	1.0000	0	0	0	1.0000	0	0	0	1.0000	0	0	0	1.0000	0	0	0	1.0000	NO	1.0000
75	EAGLE AVE (W)	0.11	42.67	POOR	37	25	0	0.5541	528	0	0	0.9722	21	13	6	0.7921	0	0	0	1.0000	0	0	0	1.0000	0	0	0	1.0000	NO	1.0000
76	EISELE DR	0.21	76.31	FAIR	0	0	0	1.0000	515	0	0	0.9729	0	10	3	0.7844	0	0	0	1.0000	0	0	0	1.0000	0	0	0	1.0000	NO	1.0000
77	EL MONTE ST	0.29	39.78	POOR	400	0	0	0.7389	0	597	205	0.9450	0	30	21	0.5698	0	0	0	1.0000	0	0	0	1.0000	0	0	0	1.0000	NO	1.0000
78	ELDERBERRY CT	0.03	20.62	VERY POOR	0	60	0	0.4397	0	31	554	0.9170	0	13	30	0.5151	0	0	0	1.0000	0	0	0	1.0000	4	0	0	0.9929	NO	1.0000
79	ELM PLACE	0.05	97.22	VERY GOOD	0	0	0	1.0000	528	0	0	0.9722	0	0	0	1.0000	0	0	0	1.0000	0	0	0	1.0000	0	0	0	1.0000	NO	1.0000
80	F ST (N)	0.05	83.72	GOOD	46	0	0	1.0000	11	0	0	0.9994	20	6	0	0.8377	0	0	0	1.0000	0	0	0	1.0000	0	0	0	1.0000	NO	1.0000
81	F ST (S)	0.10	60.11	FAIR	324	0	0	0.7650	99	0	0	0.9948	18	13	0	0.8050	0	0	0	1.0000	0	0	0	1.0000	28	0	0	0.9812	NO	1.0000
82	FERRY RD	0.42	3.22	VERY POOR	0	2112	0	0.2000	0	0	0	1.0000	0	0	30	0.4161	4898	0	0	0.4999	2	11	0	0.3869	0	0	0	1.0000	NO	1.0000
83	FILMORE ST	0.07	28.26	POOR	444	0	106	0.4427	100	100	78	0.9909	3	4	18	0.6442	0	0	0	1.0000	0	0	0	1.0000	0	0	0	1.0000	NO	1.0000
84	FIR CT	0.03	20.62	VERY POOR	0	60	0	0.4397	0	31	554	0.9170	0	13	30	0.5151	0	0	0	1.0000	0	0	0	1.0000	4	0	0	0.9929	NO	1.0000
85	FORD ST	0.02	68.48	FAIR	0	0	0	1.0000	0	0	598	0.9056	10	10	12	0.7562	0	0	0	1.0000	0	0	0	1.0000	0	0	0	1.0000	NO	1.0000
86	G ST (N)	0.05	83.72	GOOD	46	0	0	1.0000	11	0	0	0.9994	20	6	0	0.8377	0	0	0	1.0000	0	0	0	1.0000	0	0	0	1.0000	NO	1.0000
87	G ST (S)	0.10	60.11	FAIR	324	0	0	0.7650	99	0	0	0.9948	18	13	0	0.8050	0	0	0	1.0000	0	0	0	1.0000	28	0	0	0.9812	NO	1.0000
88	GARFIELD ST	0.06	28.75	POOR	0	0	0	1.0000	50	0	0	0.9974	0	20	26	0.5545	49	0	12	0.6484	4	0	1	0.5198	0	0	0	1.0000	NO	1.0000
89	GINGER CT	0.05	20.62	VERY POOR	0	60	0	0.4397	0	31	554	0.9170	0	13	30	0.5151	0	0	0	1.0000	0	0	0	1.0000	4	0	0	0.9929	NO	1.0000
90	GORDON CT	0.03	39.78	POOR	400	0	0	0.7389	0	597	205	0.9450	0	30	21	0.5698	0	0	0	1.0000	0	0	0	1.0000	0	0	0	1.0000	NO	1.0000
91	GRANT ST	0.41	GRAVEL	GRAVEL				1.0000				1.0000				1.0000				1.0000				1.0000				1.0000	NO	1.0000
92	GROUSE ST	0.07	100.00	VERY GOOD	0	0	0	1.0000	0	0	0	1.0000	0	0	0	1.0000	0	0	0	1.0000	0	0	0	1.0000	0	0	0	1.0000	NO	1.0000
93	H ST (N)	0.05	83.72	GOOD	46	0	0	1.0000	11	0	0	0.9994	20	6	0	0.8377	0	0	0	1.0000	0	0	0	1.0000	0	0	0	1.0000	NO	1.0000
94	H ST (S)	0.10	60.11	FAIR	324	0	0	0.7650	99	0	0	0.9948	18	13	0	0.8050	0	0	0	1.0000	0	0	0	1.0000	28	0	0	0.9812	NO	1.0000
95	HAMILTON ST	0.14	4.32	VERY POOR	0	900	0	0.2654	0	0	0	1.0000	0	16	16	0.6446	0	0	0	1.0000	0	9	0	0.3631	300	0	400	0.6949	NO	1.0000
96	HARRISON DR	0.13	28.26	POOR	444	0	106	0.4427	100	100	78	0.9909	3	4	18	0.6442	0	0	0	1.0000	0	0	0	1.0000	0	0	0	1.0000	NO	1.0000
97	HAWK CIR	0.02	83.91	GOOD	0	0	0	1.0000	419	0	0	0.9779	16	0	0	0.8580	0	0	0	1.0000	0	0	0	1.0000	0	0	0	1.0000	NO	1.0000
98	HAYES ST	0.08	68.48	FAIR	0	0	0	1.0000	0	0	598	0.9056	10	10	12	0.7562	0	0	0	1.0000	0	0	0	1.0000	0	0	0	1.0000	NO	1.0000
99	HECK LN	0.02	GRAVEL	GRAVEL				1.0000				1.0000				1.0000				1.0000				1.0000				1.0000	NO	1.0000
100	HEMLOCK CT	0.03	20.62	VERY POOR	0	60	0	0.4397	0	31	554	0.9170	0	13	30	0.5151	0	0	0	1.0000	0	0	0	1.0000	4	0	0	0.9929	NO	1.0000
101	HIGH DESERT LOOP	0.06	77.07	FAIR	0	0	0	1.0000	45	48	0	0.9962	7	16	0	0.7736	0	0	0	1.0000	0	0	0	1.0000	0	0	0	1.0000	NO	1.0000
102	I ST (N)	0.05	83.72	GOOD	46	0	0	1.0000	11	0	0	0.9994	20	6	0	0.8377	0	0	0	1.0000	0	0	0	1.0000	0	0	0	1.0000	NO	1.0000
103	I ST (S)	0.29	60.11	FAIR	324	0	0	0.7650	99	0	0	0.9948	18	13	0	0.8050	0	0	0	1.0000	0	0	0	1.0000	28	0	0	0.9812	NO	1.0000
104	ILEX CT	0.04	20.62	VERY POOR	0	60	0	0.4397	0	31	554	0.9170	0	13	30	0.5151	0	0	0	1.0000	0	0	0	1.0000	4	0	0	0.9929	NO	1.0000
105	J ST (N)	0.05	83.72	GOOD	46	0	0	1.0000	11	0	0	0.9994	20	6	0	0.8377	0	0	0	1.0000	0	0	0	1.0000	0	0	0	1.0000	NO	1.0000
106	J ST (S)	0.10	60.11	FAIR	324	0	0	0.7650	99	0	0	0.9948	18	13	0	0.8050	0	0	0	1.0000	0	0	0	1.0000	28	0	0	0.9812	NO	1.0000
107	JACKSON ST	0.13	5.20	VERY POOR	0	900	0	0.2654	0	0	0	1.0000	0	16	16	0.6446	0	0	0	1.0000	0	9	0	0.3631	300	400	0	0.8374	NO	1.0000
108	JANE AVE	0.07	16.61	VERY POOR	46	0	400	0.1984	11	0																				

116	KILLDEER	0.05	100.00	VERY GOOD	0	0	0	1.0000	0	0	0	1.0000	0	0	0	1.0000	0	0	0	1.0000	0	0	0	1.0000	0	0	0	1.0000	NO	1.0000
117	KITE PL	0.01	100.00	VERY GOOD	0	0	0	1.0000	0	0	0	1.0000	0	0	0	1.0000	0	0	0	1.0000	0	0	0	1.0000	0	0	0	1.0000	NO	1.0000
118	KIWI CT	0.06	20.62	VERY POOR	0	60	0	0.4397	0	31	554	0.9170	0	13	30	0.5151	0	0	0	1.0000	0	0	0	1.0000	4	0	0	0.9929	NO	1.0000
119	KLICKITAT ST	0.34	72.27	FAIR	0	0	0	1.0000	139	0	0	0.9927	6	22	2	0.7280	0	0	0	1.0000	0	0	0	1.0000	0	0	0	1.0000	NO	1.0000
120	KURZ LN	0.43	PRIVATE	PRIVATE				1.0000				1.0000				1.0000				1.0000				1.0000				1.0000	NO	1.0000
121	L ST (N)	0.05	83.72	GOOD	46	0	0	1.0000	11	0	0	0.9994	20	6	0	0.8377	0	0	0	1.0000	0	0	0	1.0000	0	0	0	1.0000	NO	1.0000
122	L ST (S)	0.10	60.11	FAIR	324	0	0	0.7650	99	0	0	0.9948	18	13	0	0.8050	0	0	0	1.0000	0	0	0	1.0000	28	0	0	0.9812	NO	1.0000
123	LARCH CT	0.06	20.62	VERY POOR	0	60	0	0.4397	0	31	554	0.9170	0	13	30	0.5151	0	0	0	1.0000	0	0	0	1.0000	4	0	0	0.9929	NO	1.0000
124	LARK RD	0.06	100.00	VERY GOOD	0	0	0	1.0000	0	0	0	1.0000	0	0	0	1.0000	0	0	0	1.0000	0	0	0	1.0000	0	0	0	1.0000	NO	1.0000
125	LAUNCH LN	0.64	90.99	GOOD	35	0	0	1.0000	220	0	0	0.9884	5	0	0	0.9206	0	0	0	1.0000	0	0	0	1.0000	0	0	0	1.0000	NO	1.0000
126	LEWIS ST (E OF WILLAMETTE)	0.30	6.13	VERY POOR	0	2112	0	0.2000	0	0	0	1.0000	0	0	0	1.0000	0	10	270	0.3298	0	4	6	0.3064	0	0	0	1.0000	NO	1.0000
127	LEWIS ST (W OF WILLAMETTE)	0.33	20.62	VERY POOR	0	60	0	0.4397	0	31	554	0.9170	0	13	30	0.5151	0	0	0	1.0000	0	0	0	1.0000	4	0	0	0.9929	NO	1.0000
128	LINCOLN	0.13	97.22	VERY GOOD	0	0	0	1.0000	528	0	0	0.9722	0	0	0	1.0000	0	0	0	1.0000	0	0	0	1.0000	0	0	0	1.0000	NO	1.0000
129	LIND RD	0.41	100.00	VERY GOOD	0	0	0	1.0000	0	0	0	1.0000	0	0	0	1.0000	0	0	0	1.0000	0	0	0	1.0000	0	0	0	1.0000	NO	1.0000
130	LINVILLE LN	0.18	GRAVEL	GRAVEL				1.0000				1.0000				1.0000				1.0000				1.0000				1.0000	NO	1.0000
131	LOCUST ST	0.16	1.21	VERY POOR	0	528	0	0.3036	85	0	0	0.9955	0	10	0	0.7752	0	0	115	0.3751	0	0	22	0.1294	0	0	3168	0.4000	NO	1.0000
132	MADISON ST	0.25	28.45	POOR	0	0	0	1.0000	0	0	0	1.0000	0	20	26	0.5545	49	0	0	0.6844	2	0	1	0.5130	0	0	0	1.0000	NO	1.0000
133	MARGARET AVE	0.17	GRAVEL	GRAVEL				1.0000				1.0000				1.0000				1.0000				1.0000				1.0000	NO	1.0000
134	MARGARET ST	0.08	GRAVEL	GRAVEL				1.0000				1.0000				1.0000				1.0000				1.0000				1.0000	NO	1.0000
135	MARIAN AVE	0.14	GRAVEL	GRAVEL				1.0000				1.0000				1.0000				1.0000				1.0000				1.0000	NO	1.0000
136	MARTIN DR	0.21	8.19	VERY POOR	0	395	0	0.3235	10	0	0	0.9995	0	5	26	0.5185	0	0	0	1.0000	0	1	0	0.4887	0	0	0	1.0000	NO	1.0000
137	MCFARLAND AVE	0.17	68.48	FAIR	0	0	0	1.0000	0	0	598	0.9056	10	10	12	0.7562	0	0	0	1.0000	0	0	0	1.0000	0	0	0	1.0000	NO	1.0000
138	MCKINLEY	0.15	97.22	VERY GOOD	0	0	0	1.0000	528	0	0	0.9722	0	0	0	1.0000	0	0	0	1.0000	0	0	0	1.0000	0	0	0	1.0000	NO	1.0000
139	MILLER LP	0.24	83.03	GOOD	0	0	0	1.0000	612	0	0	0.9677	16	0	0	0.8580	0	0	0	1.0000	0	0	0	1.0000	0	0	0	1.0000	NO	1.0000
140	MONROE ST (E)	0.22	15.35	VERY POOR	600	0	0	0.6802	1584	0	0	0.9165	0	0	50	0.2462	0	0	0	1.0000	0	0	0	1.0000	0	0	0	1.0000	NO	1.0000
141	MONROE ST (W)	0.10	4.32	VERY POOR	0	900	0	0.2654	0	0	0	1.0000	0	16	16	0.6446	0	0	0	1.0000	0	9	0	0.3631	300	0	400	0.6949	NO	1.0000
142	MUNGER LN	0.16	GRAVEL	GRAVEL				1.0000				1.0000				1.0000				1.0000				1.0000				1.0000	NO	1.0000
143	NACHES AVE	0.18	68.83	FAIR	91	0	0	0.8755	363	78	0	0.9828	33	1	0	0.8000	0	0	0	1.0000	0	0	0	1.0000	0	0	0	1.0000	NO	1.0000
144	NACHES CT	0.08	68.83	FAIR	91	0	0	0.8755	363	78	0	0.9828	33	1	0	0.8000	0	0	0	1.0000	0	0	0	1.0000	0	0	0	1.0000	NO	1.0000
145	NO NAME LN	0.07	GRAVEL	GRAVEL				1.0000				1.0000				1.0000				1.0000				1.0000				1.0000	NO	1.0000
146	NUGENT AVE	0.07	GRAVEL	GRAVEL				1.0000				1.0000				1.0000				1.0000				1.0000				1.0000	NO	1.0000
147	OLIVER AVE	0.10	76.77	FAIR	57	0	0	0.9014	0	0	0	1.0000	7	8	1	0.8517	0	0	0	1.0000	0	0	0	1.0000	0	0	0	1.0000	NO	1.0000
148	ORCHARD	0.20	97.22	VERY GOOD	0	0	0	1.0000	528	0	0	0.9722	0	0	0	1.0000	0	0	0	1.0000	0	0	0	1.0000	0	0	0	1.0000	NO	1.0000
149	ORIOLE ST	0.23	100.00	VERY GOOD	0	0	0	1.0000	0	0	0	1.0000	0	0	0	1.0000	0	0	0	1.0000	0	0	0	1.0000	0	0	0	1.0000	NO	1.0000
150	OXBOW LN	0.41	GRAVEL	GRAVEL				1.0000				1.0000				1.0000				1.0000				1.0000				1.0000	NO	1.0000
151	PAMONO DR	0.01	13.35	VERY POOR	51	0	5	0.5747	13	256	522	0.9369	0	14	20	0.6100	0	0	0	1.0000	0	1	1	0.4248	150	0	0	0.9565	NO	1.0000
152	PATTERSON AVE	0.10	76.77	FAIR	57	0	0	0.9014	0	0	0	1.0000	7	8	1	0.8517	0	0	0	1.0000	0	0	0	1.0000	0	0	0	1.0000	NO	1.0000
153	PEACH TREE LN	0.14	GRAVEL	GRAVEL				1.0000				1.0000				1.0000				1.0000				1.0000				1.0000	NO	1.0000
154	PENDLETON AVE	0.21	68.83	FAIR	91	0	0	0.8755	363	78	0	0.9828	33	1	0	0.8000	0	0	0	1.0000	0	0	0	1.0000	0	0	0	1.0000	NO	1.0000
155	PHEASANT RIDGE ST (S)	0.24	100.00	VERY GOOD	0	0	0	1.0000	0	0	0	1.0000	0	0	0	1.0000	0	0	0	1.0000	0	0	0	1.0000	0	0	0	1.0000	NO	1.0000
156	PHEASANT RIDGE ST (N)	0.24	42.67	POOR	37	25	0	0.5541	528	0	0	0.9722	21	13	6	0.7921	0	0	0	1.0000	0	0	0	1.0000	0	0	0	1.0000	NO	1.0000
157	PIERCE AVE	0.21	28.26	POOR	444	0	106	0.4427	100	100	78	0.9909	3	4	18	0.6442	0	0	0	1.0000	0	0	0	1.0000	0	0	0	1.0000	NO	1.0000
158	PINE TREE AVE	0.24	81.01	GOOD	0	0	0	1.0000	177	0	0	0.9907	3	10	2	0.8177	0	0	0	1.0000	0	0	0	1.0000	0	0	0	1.0000	NO	1.0000
159	PINE TREE LN	0.15	83.91	GOOD	0	0	0	1.0000	419	0	0	0.9779	16	0	0	0.8580	0	0	0	1.0000	0	0	0	1.0000	0	0	0	1.0000	NO	1.0000
160	POLK AVE	0.07	28.26	POOR	444	0	106	0.4427	100	100	78	0.9909	3	4	18	0.6442	0	0	0	1.0000	0	0	0	1.0000	0	0	0	1.0000	NO	1.0000
161	POLLOCK LN	0.11	GRAVEL	GRAVEL				1.0000				1.0000				1.0000				1.0000				1.0000				1.0000	NO	1.0000
162	POMONO DR	0.29	13.35	VERY POOR	51	0	5	0.5747	13	256	522	0.9369	0	14	20	0.6100	0	0	0	1.0000	0	1	1	0.4248	150	0	0	0.9565	NO	1.0000
163	POWER CITY RD	1.14	15.93	VERY POOR	0	632	0	0.2909	109	0	0	0.9943	9	0	0	0.8935	0	0	0	1.0000	1	0	0	0.6166	0	0	0	1.0000	NO	1.0000
164	POWERLINE RD	3.00	85.96	GOOD	0	0	0	1.0000	25	0	0	0.9987	2	3	0	0.9060	0	0	0	1.0000	0	0	0	1.0000	0	0	0	1.0000	YES	0.9500
165	QUINCY AVE	0.13	7.07	VERY POOR	104	931	39	0.2937	0	0	0	1.0000	0	11	0	0.7642	0	0	0	1.0000	0	0	2	0.3151	0	0	0	1.0000	NO	1.0000
166	RANDALL AVE	0.06	60.11	FAIR	324	0	0	0.7650	99	0	0	0.9948	18	13	0	0.8050	0	0	0	1.0000	0	0	0	1.0000	28	0	0	0.9812	NO	1.0000
167	RAYMOND ST	0.09	63.28	FAIR	71	0	0	0.8900	0	381	0	0.9600	7	4	13	0.7407	0	0	0	1.0000	0	0	0	1.0000	0	0	0	1.0000	NO	1.0000
168	REAGAN ST	0.08	68.48	FAIR	0	0	0	1.0000	0	0	598	0.9056	10	10	12	0.7562	0	0	0	1.0000	0	0	0	1.0000	0	0	0	1.0000		

175	ROOSEVELT ST	0.10	68.48	FAIR	0	0	0	1.0000	0	0	598	0.9056	10	10	12	0.7562	0	0	0	1.0000	0	0	0	1.0000	0	0	0	1.0000	NO	1.0000
176	ROXBURY RD	0.97	89.59	GOOD	0	0	0	1.0000	146	0	0	0.9923	8	1	0	0.9029	0	0	0	1.0000	0	0	0	1.0000	0	0	0	1.0000	NO	1.0000
177	SAGE ST	0.10	28.75	POOR	0	0	0	1.0000	50	0	0	0.9974	0	20	26	0.5545	49	0	12	0.6484	4	0	1	0.5198	0	0	0	1.0000	NO	1.0000
178	SCAPLEHORN RD	0.88	23.99	POOR	387	0	0	0.7432	264	27	0	0.9871	27	6	0	0.8174	0	0	0	1.0000	0	0	0	1.0000	0	0	3168	0.4000	NO	1.0000
179	SLOAN AVE	0.12	60.11	FAIR	324	0	0	0.7650	99	0	0	0.9948	18	13	0	0.8050	0	0	0	1.0000	0	0	0	1.0000	28	0	0	0.9812	NO	1.0000
180	SONESTA	0.12	20.62	VERY POOR	0	60	0	0.4397	0	31	554	0.9170	0	13	30	0.5151	0	0	0	1.0000	0	0	0	1.0000	4	0	0	0.9929	NO	1.0000
181	SOUTHSHORE DR	1.13	60.69	FAIR	510	0	0	0.7052	40	0	0	0.9979	15	0	0	0.8625	0	0	0	1.0000	0	0	0	1.0000	0	0	0	1.0000	NO	1.0000
182	SPARROW AVE (E)	0.12	100.00	VERY GOOD	0	0	0	1.0000	0	0	0	1.0000	0	0	0	1.0000	0	0	0	1.0000	0	0	0	1.0000	0	0	0	1.0000	NO	1.0000
183	SPARROW AVE (W)	0.13	42.67	POOR	37	25	0	0.5541	528	0	0	0.9722	21	13	6	0.7921	0	0	0	1.0000	0	0	0	1.0000	0	0	0	1.0000	NO	1.0000
184	STEPHENS AVE	0.34	GRAVEL	GRAVEL				1.0000				1.0000				1.0000				1.0000				1.0000				1.0000	NO	1.0000
185	SWITZLER AVE	0.24	60.11	FAIR	324	0	0	0.7650	99	0	0	0.9948	18	13	0	0.8050	0	0	0	1.0000	0	0	0	1.0000	28	0	0	0.9812	NO	1.0000
186	THRUSH	0.07	100.00	VERY GOOD	0	0	0	1.0000	0	0	0	1.0000	0	0	0	1.0000	0	0	0	1.0000	0	0	0	1.0000	0	0	0	1.0000	NO	1.0000
187	TRUMAN AVE	0.35	68.48	FAIR	0	0	0	1.0000	0	0	598	0.9056	10	10	12	0.7562	0	0	0	1.0000	0	0	0	1.0000	0	0	0	1.0000	NO	1.0000
188	TUCKER AVE	0.33	GRAVEL	GRAVEL				1.0000				1.0000				1.0000				1.0000				1.0000				1.0000	NO	1.0000
189	TYLER AVE	0.09	28.26	POOR	444	0	106	0.4427	100	100	78	0.9909	3	4	18	0.6442	0	0	0	1.0000	0	0	0	1.0000	0	0	0	1.0000	NO	1.0000
190	UMATILLA AVE	0.30	2.45	VERY POOR	0	311	990	0.1367	0	100	73	0.9891	0	12	32	0.4943	0	580	29	0.4144	13	2	0	0.4975	1056	0	0	0.8845	NO	1.0000
191	UMATILLA RIVER RD	3.67	78.38	GOOD	0	0	0	1.0000	277	0	0	0.9854	21	0	0	0.8373	0	0	0	1.0000	0	0	0	1.0000	0	0	0	1.0000	YES	0.9500
192	UNION ST	0.25	100.00	VERY GOOD	0	0	0	1.0000	0	0	0	1.0000	0	0	0	1.0000	0	0	0	1.0000	0	0	0	1.0000	0	0	0	1.0000	NO	1.0000
193	UNNAMED - SHADY REST	0.47	100.00	VERY GOOD	0	0	0	1.0000	0	0	0	1.0000	0	0	0	1.0000	0	0	0	1.0000	0	0	0	1.0000	0	0	0	1.0000	NO	1.0000
194	VAN BUREN DR	0.22	28.26	POOR	444	0	106	0.4427	100	100	78	0.9909	3	4	18	0.6442	0	0	0	1.0000	0	0	0	1.0000	0	0	0	1.0000	NO	1.0000
195	VOGEL AVE	0.03	GRAVEL	GRAVEL				1.0000				1.0000				1.0000				1.0000				1.0000				1.0000	NO	1.0000
196	W COLUMBIA AVE	0.11	28.75	POOR	0	0	0	1.0000	50	0	0	0.9974	0	20	26	0.5545	49	0	12	0.6484	4	0	1	0.5198	0	0	0	1.0000	NO	1.0000
197	WALLA WALLA ST	0.56	72.27	FAIR	0	0	0	1.0000	139	0	0	0.9927	6	22	2	0.7280	0	0	0	1.0000	0	0	0	1.0000	0	0	0	1.0000	NO	1.0000
198	WASHINGTON ST	0.27	28.75	POOR	0	0	0	1.0000	50	0	0	0.9974	0	20	26	0.5545	49	0	12	0.6484	4	0	1	0.5198	0	0	0	1.0000	NO	1.0000
199	WENATCHEE ST	0.27	72.27	FAIR	0	0	0	1.0000	139	0	0	0.9927	6	22	2	0.7280	0	0	0	1.0000	0	0	0	1.0000	0	0	0	1.0000	NO	1.0000
200	WESTFALL LN	0.11	GRAVEL	GRAVEL				1.0000				1.0000				1.0000				1.0000				1.0000				1.0000	NO	1.0000
201	WILDWOOD LN	0.50	GRAVEL	GRAVEL				1.0000				1.0000				1.0000				1.0000				1.0000				1.0000	NO	1.0000
202	WILLAMETTE AVE	1.10	27.24	POOR	0	280	0	0.3464	808	134	0	0.9615	28	4	0	0.8179	0	0	0	1.0000	0	0	0	1.0000	0	0	0	1.0000	NO	1.0000
203	YAKIMA ST	0.34	72.27	FAIR	0	0	0	1.0000	139	0	0	0.9927	6	22	2	0.7280	0	0	0	1.0000	0	0	0	1.0000	0	0	0	1.0000	NO	1.0000
204	YERXA	0.13	60.11	FAIR	324	0	0	0.7650	99	0	0	0.9948	18	13	0	0.8050	0	0	0	1.0000	0	0	0	1.0000	28	0	0	0.9812	NO	1.0000

Appendix C
Traffic Count Information

Brownell Blvd County 1275 Rd



Peak Hour

Date: 05/19/2022

Count Period: 4:00 PM to 6:00 PM

Peak Hour: 4:45 PM to 5:45 PM

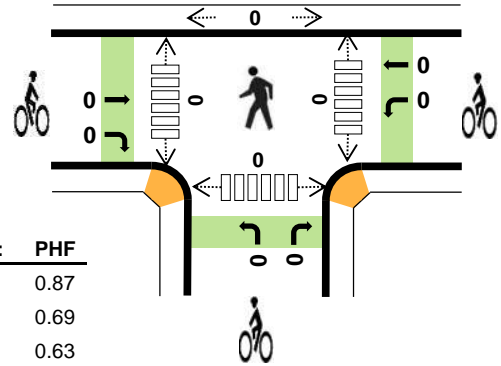
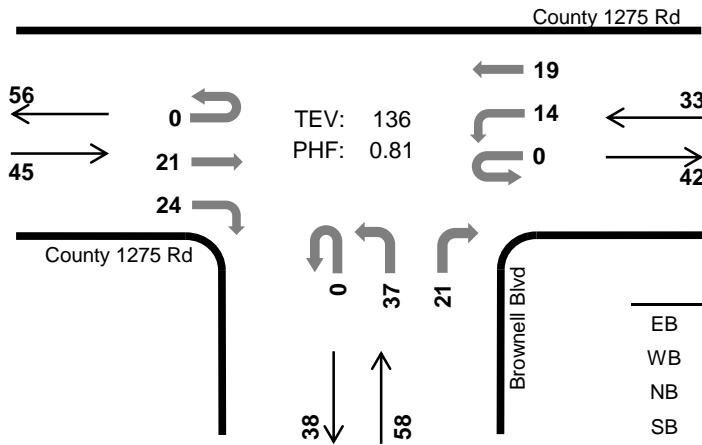

	HV %:	PHF
EB	2.2%	0.87
WB	3.0%	0.69
NB	1.7%	0.63
SB	-	-
TOTAL	2.2%	0.81

Two-Hour Count Summaries

Interval Start	County 1275 Rd Eastbound				County 1275 Rd Westbound				Brownell Blvd Northbound				Brownell Blvd Southbound				15-min Total	Rolling One Hour	
	UT	LT	TH	RT	UT	LT	TH	RT	UT	LT	TH	RT	UT	LT	TH	RT			
4:00 PM	0	0	4	9	0	2	4	0	0	7	0	1	0	0	0	0	27	0	
4:15 PM	0	0	2	9	0	5	2	0	0	8	0	0	0	0	0	0	26	0	
4:30 PM	0	0	3	4	0	3	2	0	0	4	0	4	0	0	0	0	20	0	
4:45 PM	0	0	5	8	0	3	9	0	0	9	0	5	0	0	0	0	39	112	
5:00 PM	0	0	7	4	0	3	5	0	0	19	0	4	0	0	0	0	42	127	
5:15 PM	0	0	4	8	0	5	1	0	0	3	0	6	0	0	0	0	27	128	
5:30 PM	0	0	5	4	0	3	4	0	0	6	0	6	0	0	0	0	28	136	
5:45 PM	0	0	4	4	0	3	3	0	0	4	0	5	0	0	0	0	23	120	
Count Total	0	0	34	50	0	27	30	0	0	60	0	31	0	0	0	0	232	0	
Peak Hour	All	0	0	21	24	0	14	19	0	0	37	0	21	0	0	0	0	136	0
	HV	0	0	1	0	0	0	1	0	0	1	0	0	0	0	0	0	3	0
	HV%	-	-	5%	0%	-	0%	5%	-	-	3%	-	0%	-	-	-	-	2%	0

Note: Two-hour count summary volumes include heavy vehicles but exclude bicycles in overall count.

Interval Start	Heavy Vehicle Totals					Bicycles					Pedestrians (Crossing Leg)				
	EB	WB	NB	SB	Total	EB	WB	NB	SB	Total	East	West	North	South	Total
4:00 PM	0	0	0	0	0	0	0	0	0	0	0	0	0	0	0
4:15 PM	0	0	0	0	0	0	0	0	0	0	0	0	0	0	0
4:30 PM	1	0	1	0	2	0	0	0	0	0	0	0	0	0	0
4:45 PM	1	1	0	0	2	0	0	0	0	0	0	0	0	0	0
5:00 PM	0	0	0	0	0	0	0	0	0	0	0	0	0	0	0
5:15 PM	0	0	0	0	0	0	0	0	0	0	0	0	0	0	0
5:30 PM	0	0	1	0	1	0	0	0	0	0	0	0	0	0	0
5:45 PM	0	0	0	0	0	0	0	0	0	0	0	0	0	0	0
Count Total	2	1	2	0	5	0	0	0	0	0	0	0	0	0	0
Peak Hr	1	1	1	0	3	0	0	0	0	0	0	0	0	0	0

Powerline Rd US 730



Peak Hour

Date: 05/19/2022

Count Period: 4:00 PM to 6:00 PM

Peak Hour: 4:15 PM to 5:15 PM

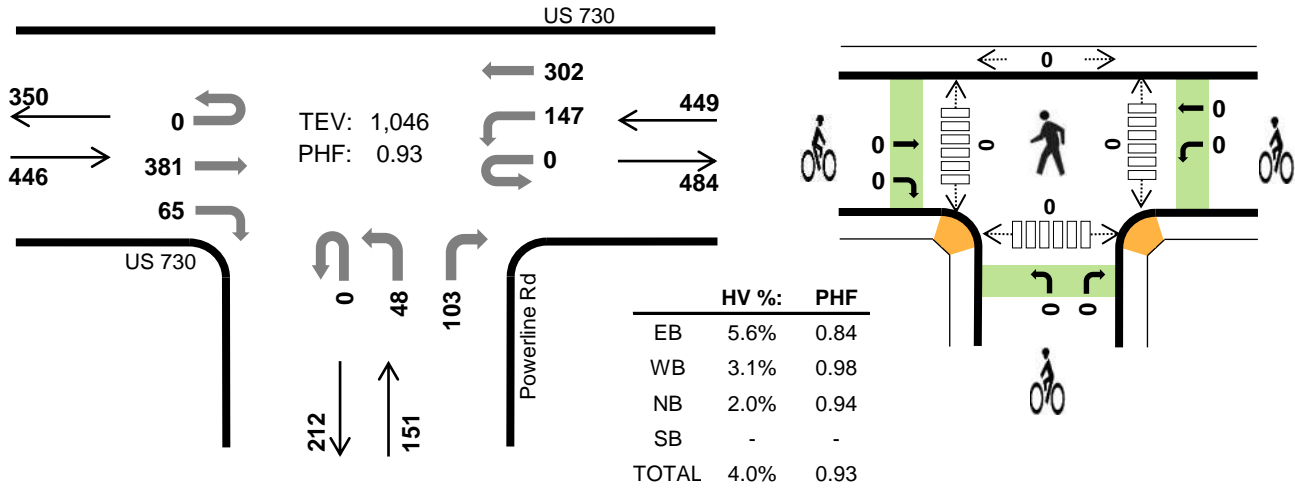

Two-Hour Count Summaries

Interval Start	US 730 Eastbound				US 730 Westbound				Powerline Rd Northbound				Powerline Rd Southbound				15-min Total	Rolling One Hour	
	UT	LT	TH	RT	UT	LT	TH	RT	UT	LT	TH	RT	UT	LT	TH	RT			
	4:00 PM	0	0	67	10	0	39	65	0	0	4	0	22	0	0	0			0
4:15 PM	0	0	111	17	0	29	82	0	0	15	0	21	0	0	0	0	275	0	
4:30 PM	0	0	93	14	0	42	70	0	0	10	0	28	0	0	0	0	257	0	
4:45 PM	0	0	115	18	0	40	72	0	0	14	0	23	0	0	0	0	282	1,021	
5:00 PM	0	0	62	16	0	36	78	0	0	9	0	31	0	0	0	0	232	1,046	
5:15 PM	0	0	76	6	0	42	72	0	0	14	0	25	0	0	0	0	235	1,006	
5:30 PM	0	0	66	11	0	46	69	0	0	11	0	34	0	0	0	0	237	986	
5:45 PM	0	0	51	6	0	34	51	0	0	8	0	27	0	0	0	0	177	881	
Count Total	0	0	641	98	0	308	559	0	0	85	0	211	0	0	0	0	1,902	0	
Peak Hour	All	0	0	381	65	0	147	302	0	0	48	0	103	0	0	0	0	1,046	0
	HV	0	0	22	3	0	0	14	0	0	0	0	3	0	0	0	0	42	0
	HV%	-	-	6%	5%	-	0%	5%	-	-	0%	-	3%	-	-	-	-	4%	0

Note: Two-hour count summary volumes include heavy vehicles but exclude bicycles in overall count.

Interval Start	Heavy Vehicle Totals					Bicycles					Pedestrians (Crossing Leg)				
	EB	WB	NB	SB	Total	EB	WB	NB	SB	Total	East	West	North	South	Total
4:00 PM	0	2	1	0	3	0	0	0	0	0	0	0	0	0	0
4:15 PM	5	5	1	0	11	0	0	0	0	0	0	0	0	0	0
4:30 PM	10	5	0	0	15	0	0	0	0	0	0	0	0	0	0
4:45 PM	5	3	2	0	10	0	0	0	0	0	0	0	0	0	0
5:00 PM	5	1	0	0	6	0	0	0	0	0	0	0	0	0	0
5:15 PM	6	1	1	0	8	0	0	0	0	0	0	0	0	0	0
5:30 PM	3	2	0	0	5	0	0	0	0	0	0	0	0	0	0
5:45 PM	3	0	0	0	3	0	0	0	0	0	0	0	0	0	0
Count Total	37	19	5	0	61	0	0	0	0	0	0	0	0	0	0
Peak Hr	25	14	3	0	42	0	0	0	0	0	0	0	0	0	0

Switzler Ave 6th St (US 730)



Date: 05/19/2022
 Count Period: 4:00 PM to 6:00 PM
 Peak Hour: 4:15 PM to 5:15 PM

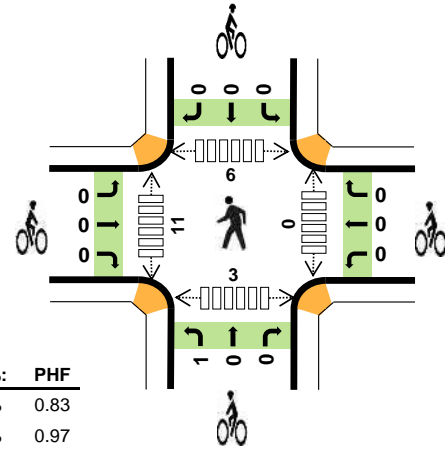
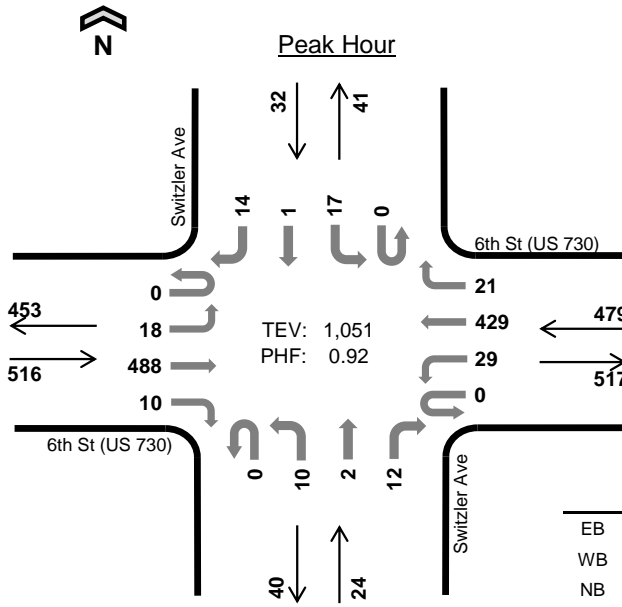

	HV %:	PHF
EB	4.8%	0.83
WB	2.5%	0.97
NB	0.0%	0.75
SB	0.0%	0.67
TOTAL	3.5%	0.92

Two-Hour Count Summaries

Interval Start	6th St (US 730) Eastbound				6th St (US 730) Westbound				Switzler Ave Northbound				Switzler Ave Southbound				15-min Total	Rolling One Hour	
	UT	LT	TH	RT	UT	LT	TH	RT	UT	LT	TH	RT	UT	LT	TH	RT			
4:00 PM	0	2	93	1	0	4	111	5	0	2	0	2	0	2	0	4	226	0	
4:15 PM	0	3	139	3	0	9	107	5	0	1	0	1	0	3	0	4	275	0	
4:30 PM	0	4	115	1	0	10	110	3	0	4	0	4	0	4	0	3	258	0	
4:45 PM	0	6	146	4	0	4	106	6	0	3	0	4	0	3	0	3	285	1,044	
5:00 PM	0	5	88	2	0	6	106	7	0	2	2	3	0	7	1	4	233	1,051	
5:15 PM	0	5	87	6	0	3	119	3	0	2	2	3	0	2	0	2	234	1,010	
5:30 PM	0	4	90	1	1	5	100	4	0	4	0	4	0	1	0	3	217	969	
5:45 PM	0	6	84	1	0	4	90	3	0	2	1	1	0	3	0	3	198	882	
Count Total	0	35	842	19	1	45	849	36	0	20	5	22	0	25	1	26	1,926	0	
Peak Hour	All	0	18	488	10	0	29	429	21	0	10	2	12	0	17	1	14	1,051	0
	HV	0	0	25	0	0	0	12	0	0	0	0	0	0	0	0	0	37	0
	HV%	-	0%	5%	0%	-	0%	3%	0%	-	0%	0%	0%	-	0%	0%	0%	4%	0

Note: Two-hour count summary volumes include heavy vehicles but exclude bicycles in overall count.

Interval Start	Heavy Vehicle Totals					Bicycles					Pedestrians (Crossing Leg)				
	EB	WB	NB	SB	Total	EB	WB	NB	SB	Total	East	West	North	South	Total
4:00 PM	2	2	1	1	6	0	0	0	0	0	0	1	0	1	2
4:15 PM	9	3	0	0	12	0	0	0	0	0	0	1	0	1	2
4:30 PM	5	4	0	0	9	0	0	1	0	1	0	2	1	1	4
4:45 PM	6	3	0	0	9	0	0	0	0	0	0	3	0	1	4
5:00 PM	5	2	0	0	7	0	0	0	0	0	0	5	5	0	10
5:15 PM	2	2	0	0	4	0	0	0	0	0	0	1	0	1	2
5:30 PM	4	0	0	1	5	0	0	0	0	0	0	1	0	2	3
5:45 PM	2	0	0	0	2	0	0	0	0	0	0	1	0	3	4
Count Total	35	16	1	2	54	0	0	1	0	1	0	15	6	10	31
Peak Hour	25	12	0	0	37	0	0	1	0	1	0	11	6	3	20

County 1275 Rd 6th St (US 730)



Peak Hour

Date: 05/19/2022

Count Period: 4:00 PM to 6:00 PM

Peak Hour: 4:15 PM to 5:15 PM

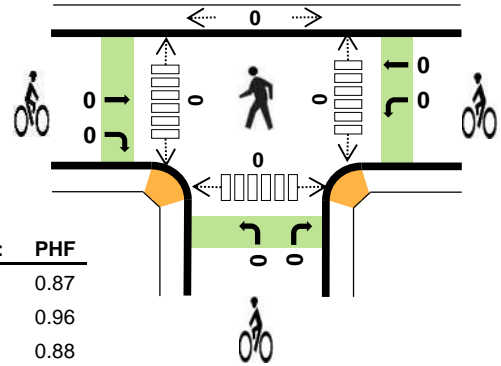
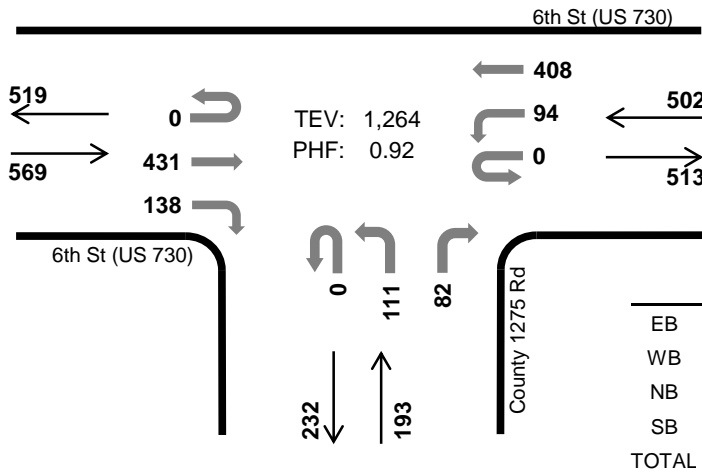

	HV %:	PHF
EB	4.9%	0.87
WB	3.8%	0.96
NB	6.7%	0.88
SB	-	-
TOTAL	4.7%	0.92

Two-Hour Count Summaries

Interval Start	6th St (US 730) Eastbound				6th St (US 730) Westbound				County 1275 Rd Northbound				County 1275 Rd Southbound				15-min Total	Rolling One Hour	
	UT	LT	TH	RT	UT	LT	TH	RT	UT	LT	TH	RT	UT	LT	TH	RT			
4:00 PM	0	0	85	28	0	26	80	0	0	35	0	19	0	0	0	0	273	0	
4:15 PM	0	0	112	41	0	20	98	0	0	24	0	16	0	0	0	0	311	0	
4:30 PM	0	0	109	37	0	29	102	0	0	31	0	15	0	0	0	0	323	0	
4:45 PM	0	0	122	41	0	27	100	0	0	23	0	29	0	0	0	0	342	1,249	
5:00 PM	0	0	88	19	0	18	108	0	0	33	0	22	0	0	0	0	288	1,264	
5:15 PM	0	0	85	21	0	14	111	0	0	31	0	19	0	0	0	0	281	1,234	
5:30 PM	0	0	72	34	0	20	80	0	0	29	0	23	0	0	0	0	258	1,169	
5:45 PM	0	0	63	29	0	21	73	0	0	31	0	14	0	0	0	0	231	1,058	
Count Total	0	0	736	250	0	175	752	0	0	237	0	157	0	0	0	0	2,307	0	
Peak Hour	All	0	0	431	138	0	94	408	0	0	111	0	82	0	0	0	0	1,264	0
	HV	0	0	25	3	0	8	11	0	0	8	0	5	0	0	0	0	60	0
	HV%	-	-	6%	2%	-	9%	3%	-	-	7%	-	6%	-	-	-	-	5%	0

Note: Two-hour count summary volumes include heavy vehicles but exclude bicycles in overall count.

Interval Start	Heavy Vehicle Totals					Bicycles					Pedestrians (Crossing Leg)				
	EB	WB	NB	SB	Total	EB	WB	NB	SB	Total	East	West	North	South	Total
4:00 PM	4	6	3	0	13	0	0	0	0	0	0	0	0	0	0
4:15 PM	9	2	3	0	14	0	0	0	0	0	0	0	0	0	0
4:30 PM	6	6	4	0	16	0	0	0	0	0	0	0	0	0	0
4:45 PM	6	7	3	0	16	0	0	0	0	0	0	0	0	0	0
5:00 PM	7	4	3	0	14	0	0	0	0	0	0	0	0	0	0
5:15 PM	5	12	0	0	17	0	0	0	0	0	0	0	0	0	0
5:30 PM	5	1	0	0	6	0	0	0	0	0	0	0	0	0	0
5:45 PM	4	6	1	0	11	0	0	0	0	0	0	0	0	0	0
Count Total	46	44	17	0	107	0	0	0	0	0	0	0	0	0	0
Peak Hr	28	19	13	0	60	0	0	0	0	0	0	0	0	0	0

Brownell Blvd 6th St (US 730)



Peak Hour

Date: 05/19/2022
Count Period: 4:00 PM to 6:00 PM
Peak Hour: 4:15 PM to 5:15 PM

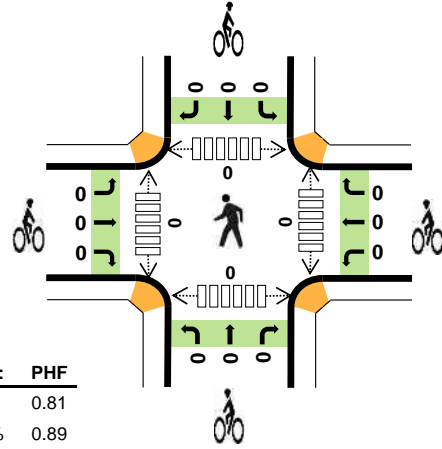
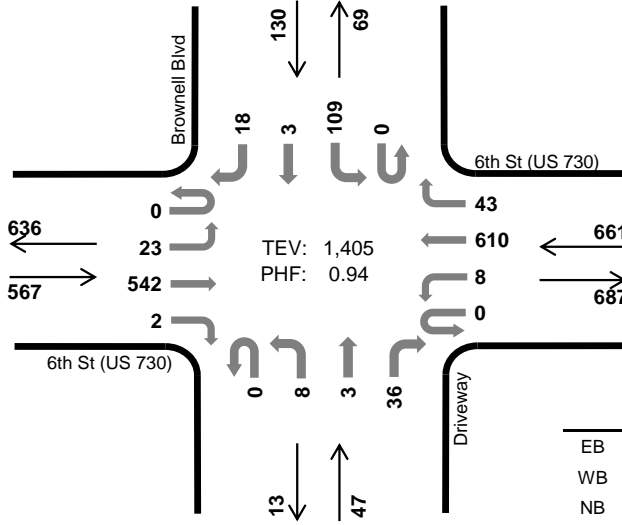

	HV %:	PHF
EB	5.8%	0.81
WB	16.0%	0.89
NB	6.4%	0.84
SB	61.5%	0.93
TOTAL	15.8%	0.94

Two-Hour Count Summaries

Interval Start	6th St (US 730) Eastbound				6th St (US 730) Westbound				Driveway Northbound				Brownell Blvd Southbound				15-min Total	Rolling One Hour	
	UT	LT	TH	RT	UT	LT	TH	RT	UT	LT	TH	RT	UT	LT	TH	RT			
4:00 PM	0	3	125	1	0	5	140	10	0	2	0	13	0	33	0	2	334	0	
4:15 PM	0	4	130	1	0	5	143	5	0	2	1	11	0	28	0	2	332	0	
4:30 PM	0	3	121	1	0	2	174	10	0	3	0	7	0	27	0	5	353	0	
4:45 PM	0	7	168	0	0	0	136	15	0	1	2	11	0	24	2	7	373	1,392	
5:00 PM	0	9	123	0	0	1	157	13	0	2	0	7	0	30	1	4	347	1,405	
5:15 PM	0	3	112	0	0	6	129	10	0	1	0	8	0	26	1	11	307	1,380	
5:30 PM	0	2	92	0	0	0	110	12	0	2	0	5	0	27	0	3	253	1,280	
5:45 PM	0	5	90	0	0	4	111	10	0	0	1	8	0	19	0	4	252	1,159	
Count Total	0	36	961	3	0	23	1,100	85	0	13	4	70	0	214	4	38	2,551	0	
Peak Hour	All	0	23	542	2	0	8	610	43	0	8	3	36	0	109	3	18	1,405	0
	HV	0	2	31	0	0	0	105	1	0	0	0	3	0	74	1	5	222	0
	HV%	-	9%	6%	0%	-	0%	17%	2%	-	0%	0%	8%	-	68%	33%	28%	16%	0

Note: Two-hour count summary volumes include heavy vehicles but exclude bicycles in overall count.

Interval Start	Heavy Vehicle Totals					Bicycles					Pedestrians (Crossing Leg)				
	EB	WB	NB	SB	Total	EB	WB	NB	SB	Total	East	West	North	South	Total
4:00 PM	12	24	0	21	57	0	0	0	0	0	0	0	0	1	1
4:15 PM	12	24	0	14	50	0	0	0	0	0	0	0	0	0	0
4:30 PM	7	31	1	24	63	0	0	0	0	0	0	0	0	0	0
4:45 PM	6	21	2	18	47	0	0	0	0	0	0	0	0	0	0
5:00 PM	8	30	0	24	62	0	0	0	0	0	0	0	0	0	0
5:15 PM	4	32	0	19	55	0	0	0	0	0	0	2	0	0	2
5:30 PM	4	19	1	22	46	0	0	0	0	0	0	1	0	0	1
5:45 PM	2	19	1	14	36	0	0	0	0	0	0	0	0	0	0
Count Total	55	200	5	156	416	0	0	0	0	0	0	3	0	1	4
Peak Hour	33	106	3	80	222	0	0	0	0	0	0	0	0	0	0

I-82 SB Ramps 6th St (US 730)



Peak Hour

Date: 05/19/2022
Count Period: 4:00 PM to 6:00 PM
Peak Hour: 4:15 PM to 5:15 PM

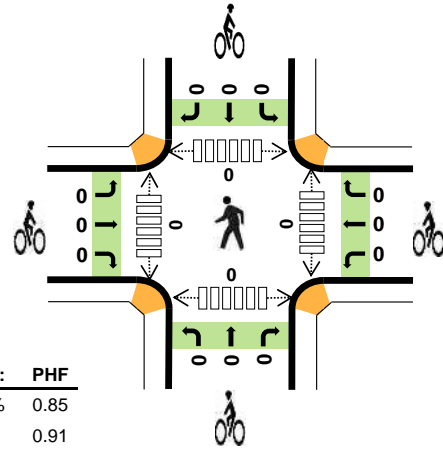
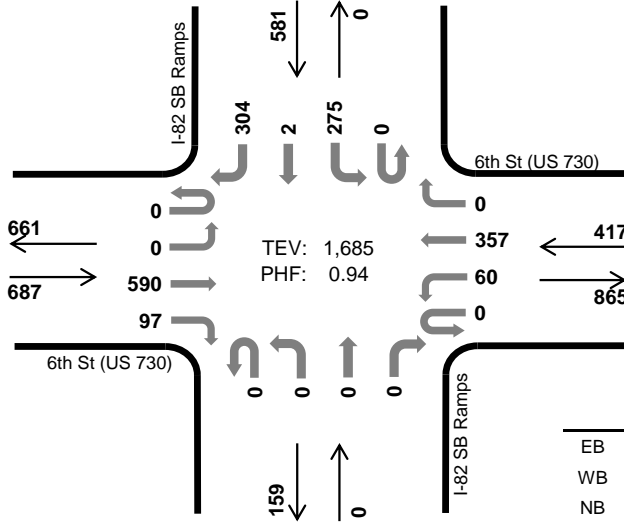

	HV %:	PHF
EB	15.7%	0.85
WB	7.0%	0.91
NB	-	-
SB	17.2%	0.93
TOTAL	14.1%	0.94

Two-Hour Count Summaries

Interval Start	6th St (US 730) Eastbound				6th St (US 730) Westbound				I-82 SB Ramps Northbound				I-82 SB Ramps Southbound				15-min Total	Rolling One Hour	
	UT	LT	TH	RT	UT	LT	TH	RT	UT	LT	TH	RT	UT	LT	TH	RT			
4:00 PM	0	0	141	30	0	18	93	0	0	0	0	0	0	51	0	62	395	0	
4:15 PM	0	0	146	23	0	13	83	0	0	0	0	0	0	58	0	70	393	0	
4:30 PM	0	0	133	22	0	20	94	0	0	0	0	0	0	63	1	92	425	0	
4:45 PM	0	0	183	20	0	8	84	0	0	0	0	0	0	86	0	67	448	1,661	
5:00 PM	0	0	128	32	0	19	96	0	0	0	0	0	0	68	1	75	419	1,685	
5:15 PM	0	0	127	19	0	15	84	0	0	0	0	0	0	75	0	61	381	1,673	
5:30 PM	0	0	99	25	0	10	74	0	0	0	0	0	0	54	1	48	311	1,559	
5:45 PM	0	0	97	20	0	10	76	0	0	0	0	0	0	51	1	49	304	1,415	
Count Total	0	0	1,054	191	0	113	684	0	0	0	0	0	0	506	4	524	3,076	0	
Peak Hour	All	0	0	590	97	0	60	357	0	0	0	0	0	0	275	2	304	1,685	0
	HV	0	0	39	69	0	17	12	0	0	0	0	0	0	6	0	94	237	0
	HV%	-	-	7%	71%	-	28%	3%	-	-	-	-	-	-	2%	0%	31%	14%	0

Note: Two-hour count summary volumes include heavy vehicles but exclude bicycles in overall count.

Interval Start	Heavy Vehicle Totals					Bicycles					Pedestrians (Crossing Leg)				
	EB	WB	NB	SB	Total	EB	WB	NB	SB	Total	East	West	North	South	Total
4:00 PM	32	15	0	21	68	0	0	0	0	0	0	0	0	1	1
4:15 PM	26	7	0	21	54	0	0	0	0	0	0	0	0	0	0
4:30 PM	28	6	0	30	64	0	0	0	0	0	0	0	0	0	0
4:45 PM	24	5	0	21	50	0	0	0	0	0	0	0	0	0	0
5:00 PM	30	11	0	28	69	0	0	0	0	0	0	0	0	0	0
5:15 PM	20	14	0	25	59	0	0	0	0	0	0	1	0	0	1
5:30 PM	26	4	0	21	51	0	0	0	0	0	0	0	0	0	0
5:45 PM	15	7	0	14	36	0	0	0	0	0	0	0	0	0	0
Count Total	201	69	0	181	451	0	0	0	0	0	0	1	0	1	2
Peak Hour	108	29	0	100	237	0	0	0	0	0	0	0	0	0	0

I-82 NB Ramps 6th St (US 730)



Date: 05/19/2022

Count Period: 4:00 PM to 6:00 PM

Peak Hour: 4:15 PM to 5:15 PM

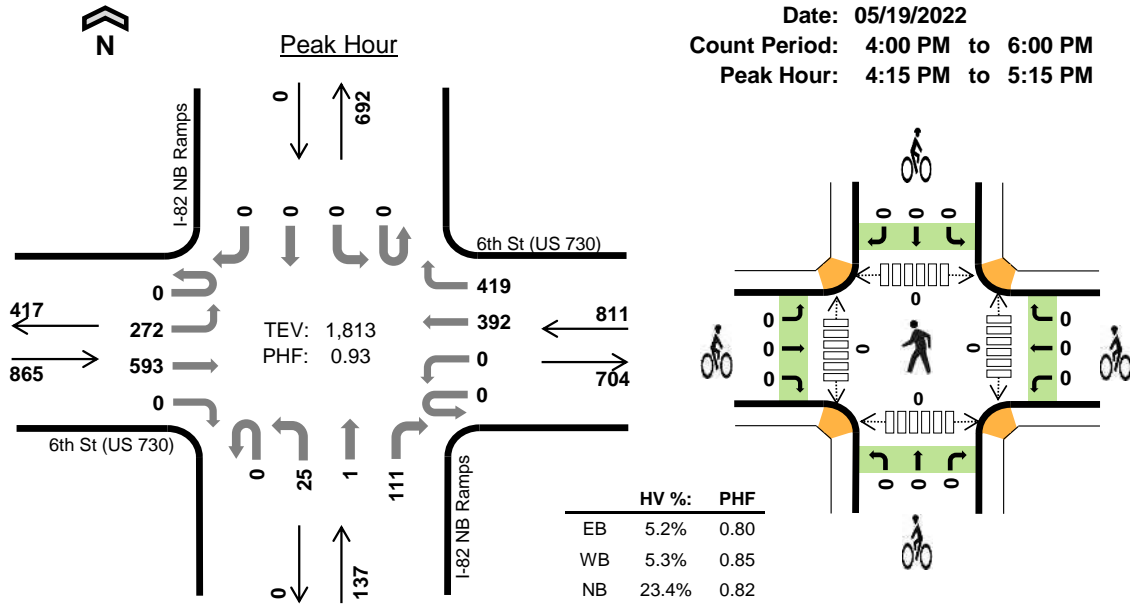

Two-Hour Count Summaries

Interval Start	6th St (US 730) Eastbound				6th St (US 730) Westbound				I-82 NB Ramps Northbound				I-82 NB Ramps Southbound				15-min Total	Rolling One Hour	
	UT	LT	TH	RT	UT	LT	TH	RT	UT	LT	TH	RT	UT	LT	TH	RT			
4:00 PM	0	60	132	0	0	0	106	79	0	5	0	32	0	0	0	0	414	0	
4:15 PM	0	67	137	0	0	0	91	93	0	5	0	25	0	0	0	0	418	0	
4:30 PM	0	73	123	0	0	0	107	131	0	7	0	31	0	0	0	0	472	0	
4:45 PM	0	76	193	0	0	0	85	90	0	7	1	34	0	0	0	0	486	1,790	
5:00 PM	0	56	140	0	0	0	109	105	0	6	0	21	0	0	0	0	437	1,813	
5:15 PM	0	51	151	0	0	0	93	72	0	6	0	25	0	0	0	0	398	1,793	
5:30 PM	0	44	109	0	0	0	80	52	0	4	0	20	0	0	0	0	309	1,630	
5:45 PM	0	35	113	0	0	0	75	9	0	11	0	19	0	0	0	0	262	1,406	
Count Total	0	462	1,098	0	0	0	746	631	0	51	1	207	0	0	0	0	3,196	0	
Peak Hour	All	0	272	593	0	0	0	392	419	0	25	1	111	0	0	0	0	1,813	0
	HV	0	8	37	0	0	0	26	17	0	3	1	28	0	0	0	0	120	0
	HV%	-	3%	6%	-	-	-	7%	4%	-	12%	100%	25%	-	-	-	-	7%	0

Note: Two-hour count summary volumes include heavy vehicles but exclude bicycles in overall count.

Interval Start	Heavy Vehicle Totals					Bicycles					Pedestrians (Crossing Leg)				
	EB	WB	NB	SB	Total	EB	WB	NB	SB	Total	East	West	North	South	Total
4:00 PM	11	17	13	0	41	0	0	0	0	0	0	0	0	0	0
4:15 PM	12	10	5	0	27	0	0	0	0	0	0	0	0	0	0
4:30 PM	11	10	8	0	29	0	0	0	0	0	0	0	0	0	0
4:45 PM	12	9	14	0	35	0	0	0	0	0	0	0	0	0	0
5:00 PM	10	14	5	0	29	0	0	0	0	0	0	0	0	0	0
5:15 PM	7	17	6	0	30	0	0	0	0	0	0	0	0	0	0
5:30 PM	10	6	5	0	21	0	0	0	0	0	0	0	0	0	0
5:45 PM	3	12	7	0	22	0	0	0	0	0	0	0	0	0	0
Count Total	76	95	63	0	234	0	0	0	0	0	0	0	0	0	0
Peak Hour	45	43	32	0	120	0	0	0	0	0	0	0	0	0	0

Two-Hour Count Summaries - Heavy Vehicles																		
Interval Start	6th St (US 730)				6th St (US 730)				I-82 NB Ramps				I-82 NB Ramps				15-min Total	Rolling One Hour
	Eastbound				Westbound				Northbound				Southbound					
	UT	LT	TH	RT	UT	LT	TH	RT	UT	LT	TH	RT	UT	LT	TH	RT		
4:00 PM	0	1	10	0	0	0	14	3	0	1	0	12	0	0	0	0	41	0
4:15 PM	0	2	10	0	0	0	7	3	0	0	0	5	0	0	0	0	27	0
4:30 PM	0	2	9	0	0	0	5	5	0	1	0	7	0	0	0	0	29	0
4:45 PM	0	3	9	0	0	0	4	5	0	1	1	12	0	0	0	0	35	132
5:00 PM	0	1	9	0	0	0	10	4	0	1	0	4	0	0	0	0	29	120
5:15 PM	0	2	5	0	0	0	14	3	0	0	0	6	0	0	0	0	30	123
5:30 PM	0	1	9	0	0	0	4	2	0	0	0	5	0	0	0	0	21	115
5:45 PM	0	1	2	0	0	0	7	5	0	0	0	7	0	0	0	0	22	102
Count Total	0	13	63	0	0	0	65	30	0	4	1	58	0	0	0	0	234	0
Peak Hour	0	8	37	0	0	0	26	17	0	3	1	28	0	0	0	0	120	0
Two-Hour Count Summaries - Bikes																		
Interval Start	6th St (US 730)			6th St (US 730)			I-82 NB Ramps			I-82 NB Ramps			15-min Total	Rolling One Hour				
	Eastbound			Westbound			Northbound			Southbound								
	LT	TH	RT	LT	TH	RT	LT	TH	RT	LT	TH	RT						
4:00 PM	0	0	0	0	0	0	0	0	0	0	0	0	0	0	0	0	0	0
4:15 PM	0	0	0	0	0	0	0	0	0	0	0	0	0	0	0	0	0	0
4:30 PM	0	0	0	0	0	0	0	0	0	0	0	0	0	0	0	0	0	0
4:45 PM	0	0	0	0	0	0	0	0	0	0	0	0	0	0	0	0	0	0
5:00 PM	0	0	0	0	0	0	0	0	0	0	0	0	0	0	0	0	0	0
5:15 PM	0	0	0	0	0	0	0	0	0	0	0	0	0	0	0	0	0	0
5:30 PM	0	0	0	0	0	0	0	0	0	0	0	0	0	0	0	0	0	0
5:45 PM	0	0	0	0	0	0	0	0	0	0	0	0	0	0	0	0	0	0
Count Total	0	0	0	0	0	0	0	0	0	0	0	0	0	0	0	0	0	0
Peak Hour	0	0	0	0	0	0	0	0	0	0	0	0	0	0	0	0	0	0
<i>Note: U-Turn volumes for bikes are included in Left-Turn, if any.</i>																		

Devore Rd 6th St (US 730)



Peak Hour

Date: 05/19/2022
Count Period: 4:00 PM to 6:00 PM
Peak Hour: 4:15 PM to 5:15 PM

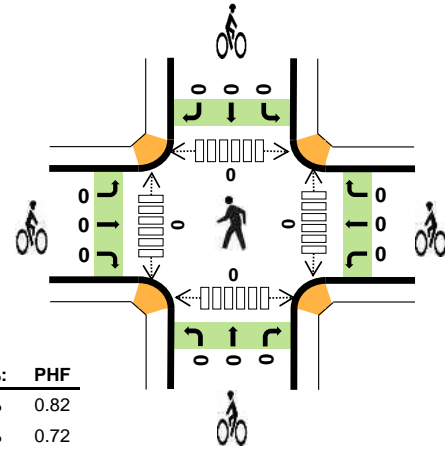
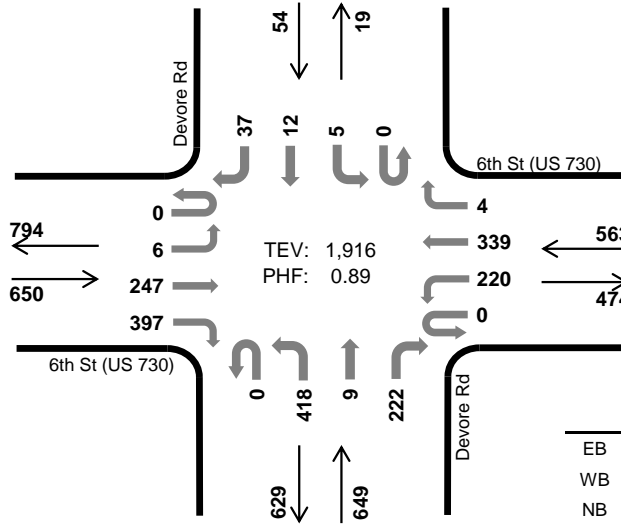

	HV %:	PHF
EB	9.2%	0.82
WB	5.3%	0.72
NB	4.0%	0.90
SB	0.0%	0.42
TOTAL	6.1%	0.89

Two-Hour Count Summaries

Interval Start	6th St (US 730) Eastbound				6th St (US 730) Westbound				Devore Rd Northbound				Devore Rd Southbound				15-min Total	Rolling One Hour	
	UT	LT	TH	RT	UT	LT	TH	RT	UT	LT	TH	RT	UT	LT	TH	RT			
4:00 PM	0	2	63	92	0	67	79	0	0	100	0	49	0	0	0	3	455	0	
4:15 PM	0	0	49	96	0	68	78	0	0	104	3	46	0	3	2	4	453	0	
4:30 PM	0	2	60	92	0	61	131	3	0	108	4	63	0	2	5	5	536	0	
4:45 PM	0	2	72	123	0	57	68	0	0	90	0	50	0	0	0	1	463	1,907	
5:00 PM	0	2	66	86	0	34	62	1	0	116	2	63	0	0	5	27	464	1,916	
5:15 PM	0	1	66	89	0	58	65	2	0	94	2	59	0	0	7	6	449	1,912	
5:30 PM	0	1	63	68	0	45	49	1	0	74	2	32	0	1	2	6	344	1,720	
5:45 PM	0	3	51	78	0	37	48	1	0	77	4	38	0	0	2	0	339	1,596	
Count Total	0	13	490	724	0	427	580	8	0	763	17	400	0	6	23	52	3,503	0	
Peak Hour	All	0	6	247	397	0	220	339	4	0	418	9	222	0	5	12	37	1,916	0
	HV	0	0	30	30	0	9	21	0	0	19	0	7	0	0	0	0	116	0
	HV%	-	0%	12%	8%	-	4%	6%	0%	-	5%	0%	3%	-	0%	0%	0%	6%	0

Note: Two-hour count summary volumes include heavy vehicles but exclude bicycles in overall count.

Interval Start	Heavy Vehicle Totals					Bicycles					Pedestrians (Crossing Leg)				
	EB	WB	NB	SB	Total	EB	WB	NB	SB	Total	East	West	North	South	Total
4:00 PM	19	11	8	0	38	0	0	0	0	0	0	0	0	0	0
4:15 PM	13	12	4	0	29	0	0	0	0	0	0	0	0	0	0
4:30 PM	16	5	6	0	27	0	0	0	0	0	0	0	0	0	0
4:45 PM	18	6	11	0	35	0	0	0	0	0	0	0	0	0	0
5:00 PM	13	7	5	0	25	0	0	0	0	0	0	0	0	0	0
5:15 PM	7	6	8	0	21	0	0	0	0	0	0	0	0	0	0
5:30 PM	14	8	3	0	25	0	0	0	0	0	0	0	0	0	0
5:45 PM	9	8	7	0	24	0	0	0	0	0	0	0	0	0	0
Count Total	109	63	52	0	224	0	0	0	0	0	0	0	0	0	0
Peak Hour	60	30	26	0	116	0	0	0	0	0	0	0	0	0	0

Two-Hour Count Summaries - Heavy Vehicles																		
Interval Start	6th St (US 730)				6th St (US 730)				Devore Rd				Devore Rd				15-min Total	Rolling One Hour
	Eastbound				Westbound				Northbound				Southbound					
	UT	LT	TH	RT	UT	LT	TH	RT	UT	LT	TH	RT	UT	LT	TH	RT		
4:00 PM	0	0	9	10	0	3	8	0	0	6	0	2	0	0	0	0	38	0
4:15 PM	0	0	6	7	0	3	9	0	0	4	0	0	0	0	0	0	29	0
4:30 PM	0	0	9	7	0	1	4	0	0	4	0	2	0	0	0	0	27	0
4:45 PM	0	0	9	9	0	3	3	0	0	7	0	4	0	0	0	0	35	129
5:00 PM	0	0	6	7	0	2	5	0	0	4	0	1	0	0	0	0	25	116
5:15 PM	0	0	4	3	0	0	6	0	0	8	0	0	0	0	0	0	21	108
5:30 PM	0	0	9	5	0	4	4	0	0	3	0	0	0	0	0	0	25	106
5:45 PM	0	0	8	1	0	2	6	0	0	6	0	1	0	0	0	0	24	95
Count Total	0	0	60	49	0	18	45	0	0	42	0	10	0	0	0	0	224	0
Peak Hour	0	0	30	30	0	9	21	0	0	19	0	7	0	0	0	0	116	0
Two-Hour Count Summaries - Bikes																		
Interval Start	6th St (US 730)			6th St (US 730)			Devore Rd			Devore Rd			15-min Total	Rolling One Hour				
	Eastbound			Westbound			Northbound			Southbound								
	LT	TH	RT	LT	TH	RT	LT	TH	RT	LT	TH	RT						
4:00 PM	0	0	0	0	0	0	0	0	0	0	0	0	0	0	0	0	0	0
4:15 PM	0	0	0	0	0	0	0	0	0	0	0	0	0	0	0	0	0	0
4:30 PM	0	0	0	0	0	0	0	0	0	0	0	0	0	0	0	0	0	0
4:45 PM	0	0	0	0	0	0	0	0	0	0	0	0	0	0	0	0	0	0
5:00 PM	0	0	0	0	0	0	0	0	0	0	0	0	0	0	0	0	0	0
5:15 PM	0	0	0	0	0	0	0	0	0	0	0	0	0	0	0	0	0	0
5:30 PM	0	0	0	0	0	0	0	0	0	0	0	0	0	0	0	0	0	0
5:45 PM	0	0	0	0	0	0	0	0	0	0	0	0	0	0	0	0	0	0
Count Total	0	0	0	0	0	0	0	0	0	0	0	0	0	0	0	0	0	0
Peak Hour	0	0	0	0	0	0	0	0	0	0	0	0	0	0	0	0	0	0
<i>Note: U-Turn volumes for bikes are included in Left-Turn, if any.</i>																		

Columbia Blvd 6th St (US 730)

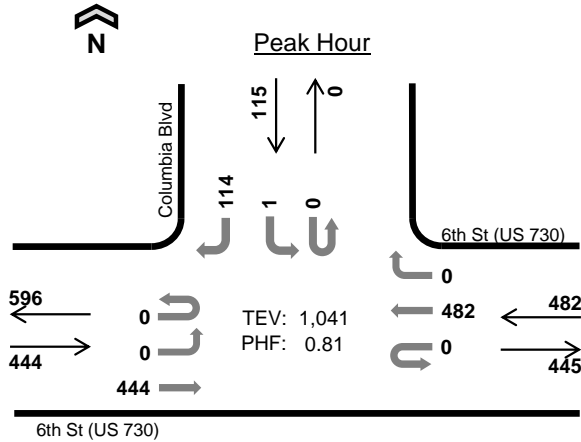

Date: 05/19/2022
Count Period: 4:00 PM to 6:00 PM
Peak Hour: 4:00 PM to 5:00 PM

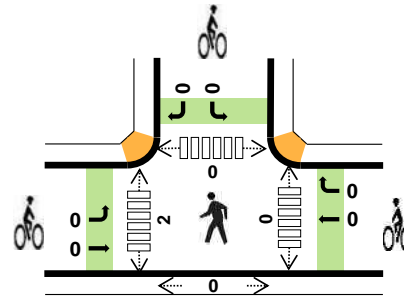

TEV: 1,041
PHF: 0.81

	HV %:	PHF
EB	9.0%	0.91
WB	6.6%	0.68
NB	-	-
SB	0.0%	0.74
TOTAL	6.9%	0.81

Two-Hour Count Summaries

Interval Start	6th St (US 730) Eastbound				6th St (US 730) Westbound				0 Northbound				Columbia Blvd Southbound				15-min Total	Rolling One Hour	
	UT	LT	TH	RT	UT	LT	TH	RT	UT	LT	TH	RT	UT	LT	TH	RT			
4:00 PM	0	0	106	0	0	0	105	0	0	0	0	0	0	1	0	38	250	0	
4:15 PM	0	0	98	0	0	0	109	0	0	0	0	0	0	0	0	28	235	0	
4:30 PM	0	0	122	0	0	0	176	0	0	0	0	0	0	0	0	23	321	0	
4:45 PM	0	0	118	0	0	0	92	0	0	0	0	0	0	0	0	25	235	1,041	
5:00 PM	0	0	117	0	0	0	80	0	0	0	0	0	0	0	0	18	215	1,006	
5:15 PM	0	0	132	0	0	0	79	0	0	0	0	0	0	0	0	46	257	1,028	
5:30 PM	0	1	78	0	0	0	66	0	0	0	0	0	0	1	0	27	173	880	
5:45 PM	0	0	86	0	0	0	72	0	0	0	0	0	0	1	0	13	172	817	
Count Total	0	1	857	0	0	0	779	0	0	0	0	0	0	3	0	218	1,858	0	
Peak Hour	All	0	0	444	0	0	0	482	0	0	0	0	0	0	1	0	114	1,041	0
	HV	0	0	40	0	0	0	32	0	0	0	0	0	0	0	0	0	72	0
	HV%	-	-	9%	-	-	-	7%	-	-	-	-	-	-	0%	-	0%	7%	0

Note: Two-hour count summary volumes include heavy vehicles but exclude bicycles in overall count.

Interval Start	Heavy Vehicle Totals					Bicycles					Pedestrians (Crossing Leg)				
	EB	WB	NB	SB	Total	EB	WB	NB	SB	Total	East	West	North	South	Total
4:00 PM	10	13	0	0	23	0	0	0	0	0	0	2	0	0	2
4:15 PM	6	8	0	0	14	0	0	0	0	0	0	0	0	0	0
4:30 PM	11	5	0	0	16	0	0	0	0	0	0	0	0	0	0
4:45 PM	13	6	0	0	19	0	0	0	0	0	0	0	0	0	0
5:00 PM	4	7	0	0	11	0	0	0	0	0	0	0	0	0	0
5:15 PM	6	7	0	2	15	0	0	0	0	0	0	0	0	0	0
5:30 PM	1	8	0	0	9	0	0	0	0	0	0	0	0	0	0
5:45 PM	10	10	0	0	20	0	0	0	0	0	0	0	0	0	0
Count Total	61	64	0	2	127	0	0	0	0	0	0	2	0	0	2
Peak Hr	40	32	0	0	72	0	0	0	0	0	0	2	0	0	2

Willamette St 6th St (US 730)

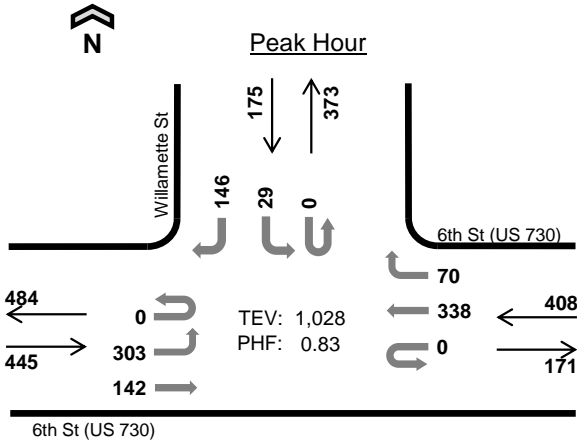

Date: 05/19/2022
Count Period: 4:00 PM to 6:00 PM
Peak Hour: 4:00 PM to 5:00 PM

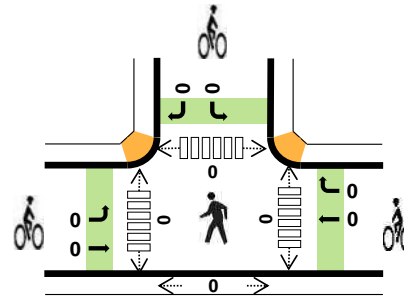

	HV %:	PHF
EB	8.8%	0.93
WB	8.8%	0.71
NB	-	-
SB	2.9%	0.88
TOTAL	7.8%	0.83

Two-Hour Count Summaries

Interval Start	6th St (US 730) Eastbound				6th St (US 730) Westbound				0 Northbound				Willamette St Southbound				15-min Total	Rolling One Hour	
	UT	LT	TH	RT	UT	LT	TH	RT	UT	LT	TH	RT	UT	LT	TH	RT			
4:00 PM	0	66	46	0	0	0	73	22	0	0	0	0	0	9	0	32	248	0	
4:15 PM	0	65	32	0	0	0	82	16	0	0	0	0	0	7	0	30	232	0	
4:30 PM	0	88	29	0	0	0	127	17	0	0	0	0	0	2	0	48	311	0	
4:45 PM	0	84	35	0	0	0	56	15	0	0	0	0	0	11	0	36	237	1,028	
5:00 PM	0	96	24	0	0	0	44	10	0	0	0	0	0	9	0	30	213	993	
5:15 PM	0	101	28	0	0	0	36	7	0	0	0	0	0	3	0	45	220	981	
5:30 PM	0	63	30	0	0	0	32	9	0	0	0	0	0	7	0	35	176	846	
5:45 PM	0	61	31	0	0	0	33	8	0	0	0	0	0	6	0	40	179	788	
Count Total	0	624	255	0	0	0	483	104	0	0	0	0	0	54	0	296	1,816	0	
Peak Hour	All	0	303	142	0	0	0	338	70	0	0	0	0	0	29	0	146	1,028	0
	HV	0	4	35	0	0	0	32	4	0	0	0	0	0	3	0	2	80	0
	HV%	-	1%	25%	-	-	-	9%	6%	-	-	-	-	-	10%	-	1%	8%	0

Note: Two-hour count summary volumes include heavy vehicles but exclude bicycles in overall count.

Interval Start	Heavy Vehicle Totals					Bicycles					Pedestrians (Crossing Leg)				
	EB	WB	NB	SB	Total	EB	WB	NB	SB	Total	East	West	North	South	Total
4:00 PM	10	15	0	2	27	0	0	0	0	0	0	0	0	0	0
4:15 PM	4	10	0	0	14	0	0	0	0	0	0	0	0	0	
4:30 PM	12	4	0	1	17	0	0	0	0	0	0	0	0	0	
4:45 PM	13	7	0	2	22	0	0	0	0	0	0	0	0	0	
5:00 PM	5	8	0	0	13	0	0	0	0	0	0	0	0	0	
5:15 PM	6	9	0	0	15	0	0	0	0	0	0	0	0	0	
5:30 PM	5	8	0	0	13	0	0	0	0	0	0	0	0	0	
5:45 PM	9	10	0	1	20	0	0	0	0	0	0	0	0	0	
Count Total	64	71	0	6	141	0	0	0	0	0	0	0	0	0	
Peak Hr	39	36	0	5	80	0	0	0	0	0	0	0	0	0	

Bud Draper Rd 6th St (US 730)

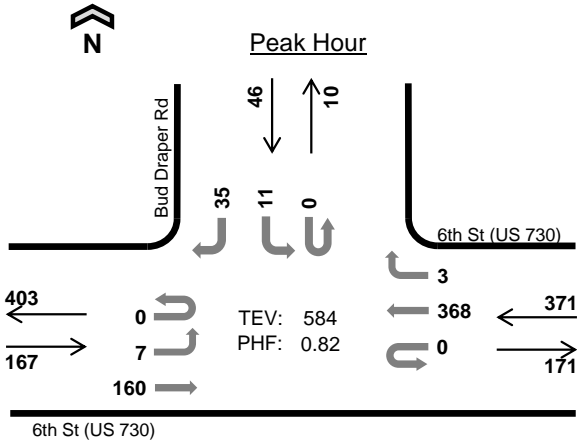

Date: 05/19/2022
Count Period: 4:00 PM to 6:00 PM
Peak Hour: 4:00 PM to 5:00 PM

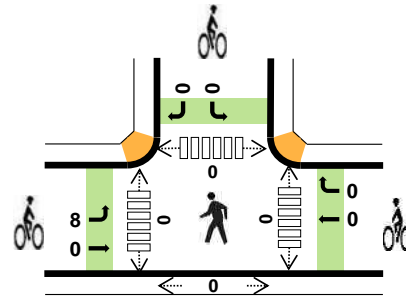

	HV %:	PHF
EB	19.2%	0.77
WB	8.4%	0.64
NB	-	-
SB	8.7%	0.77
TOTAL	11.5%	0.82

Two-Hour Count Summaries

Interval Start	6th St (US 730) Eastbound				6th St (US 730) Westbound				0 Northbound				Bud Draper Rd Southbound				15-min Total	Rolling One Hour	
	UT	LT	TH	RT	UT	LT	TH	RT	UT	LT	TH	RT	UT	LT	TH	RT			
	4:00 PM	0	2	52	0	0	0	78	2	0	0	0	0	0	2	0			13
4:15 PM	0	1	35	0	0	0	87	1	0	0	0	0	0	2	0	9	135	0	
4:30 PM	0	1	27	0	0	0	144	0	0	0	0	0	0	4	0	2	178	0	
4:45 PM	0	3	46	0	0	0	59	0	0	0	0	0	0	3	0	11	122	584	
5:00 PM	0	0	32	0	0	0	45	0	0	0	0	0	0	1	0	12	90	525	
5:15 PM	0	0	35	0	0	0	42	0	0	0	0	0	0	0	0	4	81	471	
5:30 PM	0	1	33	0	0	0	37	0	0	0	0	0	0	0	0	1	72	365	
5:45 PM	0	1	30	0	0	0	41	0	0	0	0	0	0	0	0	5	77	320	
Count Total	0	9	290	0	0	0	533	3	0	0	0	0	0	12	0	57	904	0	
Peak Hour	All	0	7	160	0	0	0	368	3	0	0	0	0	0	11	0	35	584	0
	HV	0	0	32	0	0	0	30	1	0	0	0	0	0	3	0	1	67	0
	HV%	-	0%	20%	-	-	-	8%	33%	-	-	-	-	-	27%	-	3%	11%	0

Note: Two-hour count summary volumes include heavy vehicles but exclude bicycles in overall count.

Interval Start	Heavy Vehicle Totals					Bicycles					Pedestrians (Crossing Leg)							
	EB	WB	NB	SB	Total	EB	WB	NB	SB	Total	East	West	North	South	Total			
4:00 PM	10	14	0	0	24	0	0	0	0	0	0	0	0	0	0	0	0	0
4:15 PM	3	8	0	2	13	5	0	0	0	5	0	0	0	0	0	0	0	0
4:30 PM	7	4	0	1	12	1	0	0	0	1	0	0	0	0	0	0	0	0
4:45 PM	12	5	0	1	18	2	0	0	0	2	0	0	0	0	0	0	0	0
5:00 PM	3	7	0	1	11	0	0	0	0	0	0	0	0	0	0	0	0	0
5:15 PM	6	10	0	0	16	1	0	0	0	1	0	0	0	0	0	0	0	0
5:30 PM	6	6	0	0	12	1	0	0	0	1	0	0	0	0	0	0	0	0
5:45 PM	7	6	0	2	15	3	0	0	0	3	0	0	0	0	0	0	0	0
Count Total	54	60	0	7	121	13	0	0	0	13	0	0	0	0	0	0	0	0
Peak Hr	32	31	0	4	67	8	0	0	0	8	0	0	0	0	0	0	0	0

Beach Access Rd 6th St (US 730)

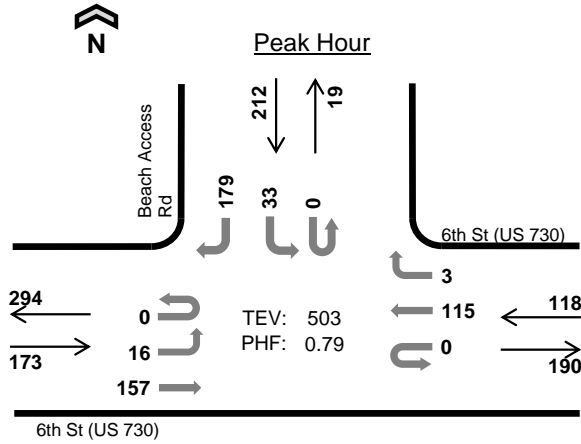

Date: 05/19/2022
 Count Period: 4:00 PM to 6:00 PM
 Peak Hour: 4:00 PM to 5:00 PM

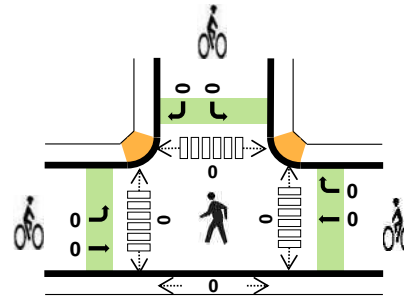

	HV %:	PHF
EB	19.7%	0.85
WB	18.6%	0.80
NB	-	-
SB	5.7%	0.64
TOTAL	13.5%	0.79

Two-Hour Count Summaries

Interval Start	6th St (US 730) Eastbound				6th St (US 730) Westbound				0 Northbound				Beach Access Rd Southbound				15-min Total	Rolling One Hour	
	UT	LT	TH	RT	UT	LT	TH	RT	UT	LT	TH	RT	UT	LT	TH	RT			
	4:00 PM	0	9	42	0	0	0	35	2	0	0	0	0	0	10	0			35
4:15 PM	0	3	35	0	0	0	23	0	0	0	0	0	0	9	0	51	121	0	
4:30 PM	0	2	39	0	0	0	34	1	0	0	0	0	0	11	0	72	159	0	
4:45 PM	0	2	41	0	0	0	23	0	0	0	0	0	0	3	0	21	90	503	
5:00 PM	0	3	30	0	0	0	22	1	0	0	0	0	0	2	0	20	78	448	
5:15 PM	0	6	25	0	0	0	24	1	0	0	0	0	0	2	0	10	68	395	
5:30 PM	0	6	24	0	0	0	27	0	0	0	0	0	0	1	0	9	67	303	
5:45 PM	0	6	21	0	0	0	22	1	0	0	0	0	0	1	0	7	58	271	
Count Total	0	37	257	0	0	0	210	6	0	0	0	0	0	39	0	225	774	0	
Peak Hour	All	0	16	157	0	0	0	115	3	0	0	0	0	0	33	0	179	503	0
	HV	0	2	32	0	0	0	22	0	0	0	0	0	0	4	0	8	68	0
	HV%	-	13%	20%	-	-	-	19%	0%	-	-	-	-	-	12%	-	4%	14%	0

Note: Two-hour count summary volumes include heavy vehicles but exclude bicycles in overall count.

Interval Start	Heavy Vehicle Totals					Bicycles					Pedestrians (Crossing Leg)							
	EB	WB	NB	SB	Total	EB	WB	NB	SB	Total	East	West	North	South	Total			
4:00 PM	9	10	0	6	25	0	0	0	0	0	0	0	0	0	0	0	0	0
4:15 PM	6	4	0	1	11	0	0	0	0	0	0	0	0	0	0	0	0	0
4:30 PM	9	5	0	3	17	0	0	0	0	0	0	0	0	0	0	0	0	0
4:45 PM	10	3	0	2	15	0	0	0	0	0	0	0	0	0	0	0	0	0
5:00 PM	4	4	0	5	13	0	0	0	0	0	0	0	0	0	0	0	0	0
5:15 PM	6	5	0	3	14	0	0	0	0	0	0	0	0	0	0	0	0	0
5:30 PM	6	5	0	2	13	0	0	0	0	0	0	0	0	0	0	0	0	0
5:45 PM	7	4	0	0	11	0	0	0	0	0	0	0	0	0	0	0	0	0
Count Total	57	40	0	22	119	0	0	0	0	0	0	0	0	0	0	0	0	0
Peak Hr	34	22	0	12	68	0	0	0	0	0	0	0	0	0	0	0	0	0

PM Peak Period HourTurning Movement Volumes

Powerline/Madison

Time	Northbound			Southbound			Eastbound			Westbound			15-minute volume	Rolling Hourly Volume
	Left	Thru	Right	Left	Thru	Right	Left	Thru	Right	Left	Thru	Right		
4:00 - 4:15	2	18	0	0	41	4	4	0	2	0	0	0	71	319
4:15 - 4:30	3	36	0	0	32	2	2	0	0	0	0	0	75	327
4:30 - 4:45	2	40	0	0	40	3	7	0	2	0	0	0	94	340
4:45 - 5:00	2	31	0	0	39	2	3	0	2	0	0	0	79	299
5:00 - 5:15	1	33	0	0	42	2	1	0	0	0	0	0	79	292
5:15 - 5:30	3	41	0	0	39	4	1	0	0	0	0	0	88	
5:30 - 5:45	2	25	0	0	23	1	1	0	1	0	0	0	53	
5:45 - 6:00	1	36	0	0	32	2	1	0	0	0	0	0	72	
TOTAL	16	260	0	0	288	20	20	0	7	0	0	0	611	

Pk Hr Factor

0.9043

pk Hour Total	8	145	0	0	160	11	12	0	4	0	0	0	340	
---------------	---	-----	---	---	-----	----	----	---	---	---	---	---	-----	--

Location	I-82/OregonWashington State Line ; McNARY HIGHWAY NO. 70; 0.58 miles south of OregonWashington State Line	Site Name	Umatilla Bridge (30-025)
		Installed	April, 1977

HISTORICAL ANNUAL TRAFFIC DATA						
Year	Annual Average Daily Traffic (AADT)	Critical Values as percent of Annual Average Daily Traffic (AADT)				
		Max Day	Max Hour	10th Hour	20th Hour	30th Hour
		2011	18100	152.1	12.0	11.0
2012	17880	143.7	12.5	11.1	10.8	10.5
2013	18487	147.3	12.9	11.4	10.9	10.6
2014	18997	146.5	13.1	11.3	10.8	10.6
2015	20465	141.2	12.5	10.8	10.4	10.2
2016	21700	149.4	12.1	10.9	10.5	10.3
2017	21600	155.8	11.6	10.7	10.6	10.5
2018	21528	145.9	11.0	10.4	10.2	10.1
2019	21595	140.3	11.0	10.6	10.3	9.9
2020	20908	153.4	11.7	11.0	10.9	10.8

2020 SEASONAL TRAFFIC DATA				
Month	Weekday		Daily	
	Average	% AADT	Average	% AADT
January	13210	63	13210	63
February	20882	100	19797	95
March	19896	95	18613	89
April	16799	80	15319	73
May	20644	99	19422	93
June	24727	118	23840	114
July	26721	128	25721	123
August	26904	129	26239	125
September	25631	123	24668	118
October	25447	122	24655	118
November	21328	102	20540	98
December	19803	95	18876	90

Highest Hour					
Date	Day	Hours of Day	Rank	Volume	%AADT
09/04/2020	Friday	3:00 - 4:00 pm	1	2451	11.7
10/09/2020	Friday	4:00 - 5:00 pm	10	2309	11.0
07/24/2020	Friday	3:00 - 4:00 pm	20	2275	10.9
08/14/2020	Friday	4:00 - 5:00 pm	30	2253	10.8
08/28/2020	Friday	4:00 - 5:00 pm	40	2233	10.7
10/23/2020	Friday	4:00 - 5:00 pm	50	2217	10.6

Highest Day			
Date	Day	Volume	AADT
09/04/2020	Friday	32080	153.4

Comments:

Location	730/Columbia River Highway Conn. from OR37 ; COLUMBIA RIVER HIGHWAY NO. 2; 0.18 miles ne of Columbia River Highway Conn. from OR37	Site Name	Cold Springs (30-002)
		Installed	October, 1962

HISTORICAL ANNUAL TRAFFIC DATA						
Year	Annual Average Daily Traffic (AADT)	Critical Values as percent of Annual Average Daily Traffic (AADT)				
		Max Day	Max Hour	10th Hour	20th Hour	30th Hour
		2011	2547	***	***	***
2012	2775	***	***	***	***	***
2013	2415	***	***	***	***	***
2014	2792	***	***	***	***	***
2015	2746	***	***	***	***	***
2016	3121	***	***	***	***	***
2017	2803	***	***	***	***	***
2018	3263	***	***	***	***	***
2019	3313	***	***	***	***	***
2020	2247	***	***	***	***	***

2020 SEASONAL TRAFFIC DATA				
Month	Weekday		Daily	
	Average	% AADT	Average	% AADT
January	2550	113	4162	185
February	2650	118	2650	118
March	2250	100	2250	100
April	1840	82	1840	82
May	2060	92	2060	92
June	2250	100	2250	100
July	2180	97	2180	97
August	2140	95	2140	95
September	2110	94	2110	94
October	2050	91	2050	91
November	1740	77	1740	77
December	1540	69	1540	69

Highest Hour					
Date	Day	Hours of Day	Rank	Volume	%AADT
***	***	***	***	***	***
***	***	***	***	***	***
***	***	***	***	***	***
***	***	***	***	***	***
***	***	***	***	***	***

Highest Day			
Date	Day	Volume	AADT
01/05/2020	Sunday	13840	615.9

Comments:
2020 - Site was down all year.

Location	I-82; MP 0.58; McNARY HIGHWAY NO. 70; 0.58 mile south of Oregon-Washington State line	Site Name	Umatilla Bridge (30-025)
		Installed	April, 1977

HISTORICAL ANNUAL TRAFFIC DATA						
Year	Annual Average Daily Traffic (AADT)	Critical Values as percent of Annual Average Daily Traffic (AADT)				
		Max Day	Max Hour	10th Hour	20th Hour	30th Hour
		2010	17854	148	11.7	11.1
2011	18100	152	12.0	11.0	10.6	10.4
2012	17880	144	12.5	11.1	10.8	10.5
2013	18487	147	12.9	11.4	10.9	10.6
2014	18997	146	13.1	11.3	10.8	10.6
2015	20465	141	12.5	10.8	10.4	10.2
2016	21647	150	12.1	10.9	10.6	10.3
2017	21644	155	11.7	10.8	10.7	10.6
2018	21528	146	11.0	10.4	10.2	10.1
2019	21595	***	***	***	***	***

2019 - Construction, weather, or connectivity outages most of the year

2019 SEASONAL TRAFFIC DATA				
Month	Weekday		Daily	
	Average	% AADT	Average	% AADT
January	17771	82	17515	81
February	14150	66	13514	63
March	20049	93	20414	95
April	22862	106	23286	108
May	23508	109	23830	110
June	24782	115	25065	116
July	25100	116	25300	117
August	26000	120	25200	117
September	23700	110	23700	110
October	22000	102	22300	103
November	20801	96	20814	96
December	17800	82	18200	84

Use 2019 Seasonal Factors with caution – Many volumes were estimated

Location	US730; MP 193.70; COLUMBIA RIVER HIGHWAY NO. 2; 0.24 mile east of Pendleton-Cold Springs Highway No. 36 (OR37)	Site Name	Cold Springs (30-002)
		Installed	October, 1962

HISTORICAL ANNUAL TRAFFIC DATA						
Year	Annual Average Daily Traffic (AADT)	Critical Values as percent of Annual Average Daily Traffic (AADT)				
		Max Day	Max Hour	10th Hour	20th Hour	30th Hour
2010	2452	162	14.3	11.5	11.0	10.8
2011	2547	***	***	***	***	***
2012	2775	***	***	***	***	***
2013	2415	***	***	***	***	***
2014	2792	***	***	***	***	***
2015	2746	***	***	***	***	***
2016	3121	***	***	***	***	***
2017	2803	***	***	***	***	***
2018	3263	***	***	***	***	***
2019	3313	***	***	***	***	***

2019 SEASONAL TRAFFIC DATA				
Month	Weekday		Daily	
	Average	% AADT	Average	% AADT
January	2650	80	2500	75
February	2200	66	2200	66
March	3050	92	3000	91
April	3660	110	3500	106
May	3700	112	3550	107
June	3950	119	3950	119
July	4100	124	4100	124
August	4100	124	4100	124
September	4000	121	3850	116
October	3770	114	3550	107
November	3300	100	2900	88
December	2650	80	2550	77

**Umatilla Transportation System Plan Update
PM Peak Hour Turning Movement Volumes**

Brownell/3rd

	Northbound			Southbound			Eastbound			Westbound			Total Volume	PHF
	Left	Thru	Right	Left	Thru	Right	Left	Thru	Right	Left	Thru	Right		
2022 May PM Peak Hour	37	0	21	0	0	0	0	21	24	14	19	0	136	
Existing PM Pk Hr w/Seasonal Adj	40	0	25	0	0	0	0	25	25	15	20	0	150	
Powerline/6th (US 730)														
2022 May PM Peak Hour	48	0	103	0	0	0		381	65	147	302	0	1046	0.94
Existing PM Pk Hr w/Seasonal Adj	55	0	115	0	0	0	0	425	75	165	340	0	1175	
Switzler/6th (US 730)														
2022 May PM Peak Hour	10	2	12	17	1	14	18	488	10	29	429	21	1051	0.92
Existing PM Pk Hr w/Seasonal Adj	10	2	15	20	1	15	20	545	10	30	480	25	1173	
Umatilla River Road (County Road 1275)/6th (US 730)														
2022 May PM Peak Hour	111	0	82	0	0	0	0	431	138	94	408	0	1264	0.92
Existing PM Pk Hr w/Seasonal Adj	125	0	90	0	0	0	0	485	155	105	455	0	1415	
Brownelle/6th (US 730)														
2022 May PM Peak Hour	8	3	36	109	3	18	23	542	2	8	610	43	1405	0.94
Existing PM Pk Hr w/Seasonal Adj	10	5	40	120	5	20	25	605	2	10	685	50	1577	
I-82 EB ramps (southbound)/6th (US 730)														
2022 May PM Peak Hour	0	0	0	275	2	304	0	590	97	60	357	0	1685	0.94
Existing PM Pk Hr w/Seasonal Adj	0	0	0	310	2	340	0	660	110	65	400	0	1887	
I-82 WB ramps (northbound)/6th (US 730)														
2022 May PM Peak Hour	25	1	111	0	0	0	272	593	0	0	392	419	1813	0.93
Existing PM Pk Hr w/Seasonal Adj	30	1	125	0	0	0	305	665	0	0	440	470	2036	
US 395/Devore Rd/6th St (US 730)														
2022 May PM Peak Hour	418	9	222	5	12	37	6	247	397	220	339	4	1916	0.89
Existing PM Pk Hr w/Seasonal Adj	470	10	250	5	15	40	5	275	445	245	380	5	2145	
Columbia/6th (US 730)														
2022 May PM Peak Hour	0	0	0	1	0	114	0	444	0	0	482	0	1041	0.81
Existing PM Pk Hr w/Seasonal Adj	0	0	0	1	0	130	0	495	0	0	540	0	1166	
Willamette/6th (US 730)														
2022 May PM Peak Hour	0	0	0	29	0	146	303	142	0	0	338	70	1028	0.83
Existing PM Pk Hr w/Seasonal Adj	0	0	0	30	0	165	340	160	0	0	380	80	1155	
Bud Draper/6th St (US 730)														
2022 May PM Peak Hour	0	0	0	11	0	35	7	160	0	0	368	3	584	0.82
Existing PM Pk Hr w/Seasonal Adj	0	0	0	10	0	40	10	180	0	0	410	5	655	
Beach Access/ (US 730)														
2022 May PM Peak Hour	0	0	0	33	0	179	16	157	0	0	115	3	503	0.79
Existing PM Pk Hr w/Seasonal Adj	0	0	0	35	0	200	20	175	0	0	130	5	565	
Madison/Powerline														
2022 Sept PM Peak Hour	8	145	0	0	160	11	12	0	4	0	0	0	340	
Existing PM Pk Hr w/Seasonal Adj	10	160	0	0	180	10	15	0	5	0	0	0	380	

Appendix D
Existing Conditions Capacity Analysis Worksheets

HCS7 Two-Way Stop-Control Report

General Information		Site Information	
Analyst	Montgomery	Intersection	Brownell-Third
Agency/Co.	JUB Engineers	Jurisdiction	City of Umatilla
Date Performed	11/18/2022	East/West Street	County Rd 1275 (Third St)
Analysis Year	2022	North/South Street	Brownelle Blvd
Time Analyzed	PM Pk Hr - Season adj	Peak Hour Factor	0.81
Intersection Orientation	East-West	Analysis Time Period (hrs)	0.25
Project Description	Umatilla Transportation System Plan		

Lanes

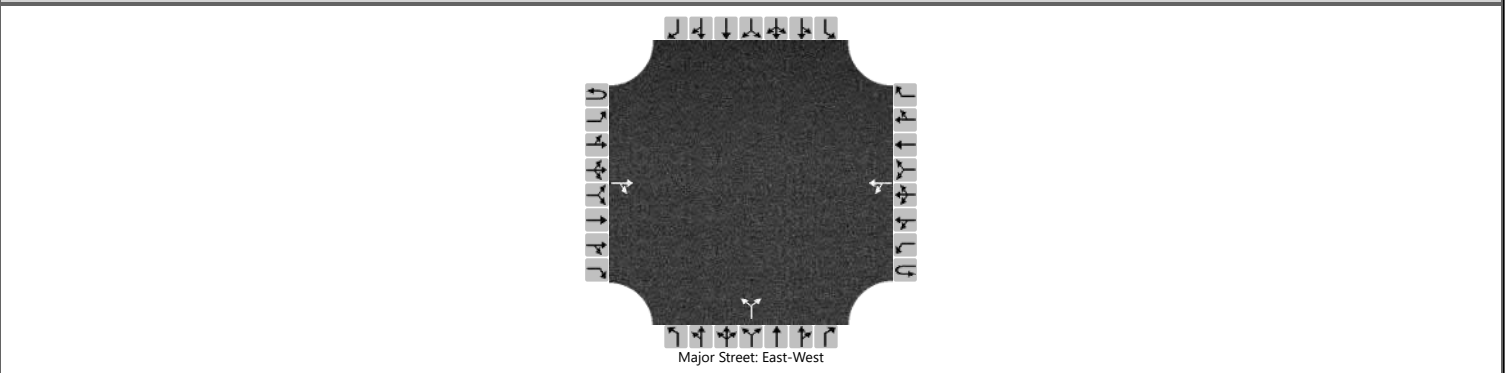

Vehicle Volumes and Adjustments

Approach	Eastbound				Westbound				Northbound				Southbound			
	U	L	T	R	U	L	T	R	U	L	T	R	U	L	T	R
Movement	1U	1	2	3	4U	4	5	6	7	8	9		10	11	12	
Priority																
Number of Lanes	0	0	1	0	0	0	1	0	0	1	0		0	0	0	
Configuration				TR		LT					LR					
Volume (veh/h)			25	25		15	20			40		25				
Percent Heavy Vehicles (%)						3				3		3				
Proportion Time Blocked																
Percent Grade (%)										3						
Right Turn Channelized																
Median Type Storage	Undivided															

Critical and Follow-up Headways

Base Critical Headway (sec)						4.1				7.1		6.2				
Critical Headway (sec)						4.13				7.03		6.53				
Base Follow-Up Headway (sec)						2.2				3.5		3.3				
Follow-Up Headway (sec)						2.23				3.53		3.33				

Delay, Queue Length, and Level of Service

Flow Rate, v (veh/h)						19				80						
Capacity, c (veh/h)						1535				914						
v/c Ratio						0.01				0.09						
95% Queue Length, Q ₉₅ (veh)						0.0				0.3						
Control Delay (s/veh)						7.4				9.3						
Level of Service (LOS)						A				A						
Approach Delay (s/veh)					3.2				9.3							
Approach LOS					A				A							

HCS7 Two-Way Stop-Control Report

General Information				Site Information			
Analyst	Montgomery	Intersection	Powerline/US 730				
Agency/Co.	JUB Engineers	Jurisdiction	City of Umatilla				
Date Performed	11/18/2022	East/West Street	6th Street (US 730)				
Analysis Year	2022	North/South Street	Powerline Road				
Time Analyzed	PM Pk Hr season adj	Peak Hour Factor	0.93				
Intersection Orientation	East-West	Analysis Time Period (hrs)	0.25				
Project Description	Umatilla Transportation System Plan						

Lanes

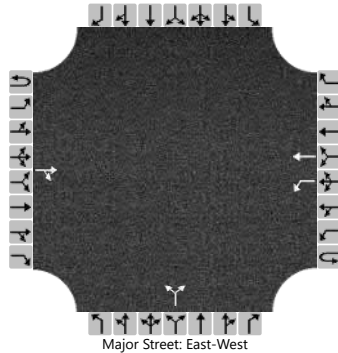

Vehicle Volumes and Adjustments

Approach	Eastbound				Westbound				Northbound				Southbound			
	U	L	T	R	U	L	T	R	U	L	T	R	U	L	T	R
Movement	1U	1	2	3	4U	4	5	6		7	8	9		10	11	12
Priority																
Number of Lanes	0	0	1	0	0	1	1	0		0	1	0		0	0	0
Configuration				TR		L	T				LR					
Volume (veh/h)			425	75		165	340			55		115				
Percent Heavy Vehicles (%)						3				3		3				
Proportion Time Blocked																
Percent Grade (%)									0							
Right Turn Channelized																
Median Type Storage	Undivided															

Critical and Follow-up Headways

Base Critical Headway (sec)						4.1					7.1		6.2			
Critical Headway (sec)						4.13					6.43		6.23			
Base Follow-Up Headway (sec)						2.2					3.5		3.3			
Follow-Up Headway (sec)						2.23					3.53		3.33			

Delay, Queue Length, and Level of Service

Flow Rate, v (veh/h)						177					183					
Capacity, c (veh/h)						1026					412					
v/c Ratio						0.17					0.44					
95% Queue Length, Q ₉₅ (veh)						0.6					2.2					
Control Delay (s/veh)						9.2					20.5					
Level of Service (LOS)						A					C					
Approach Delay (s/veh)					3.0				20.5							
Approach LOS									C							

HCS7 Two-Way Stop-Control Report

General Information				Site Information			
Analyst	Montgomery	Intersection	Switzer/US 730				
Agency/Co.	JUB Engineers	Jurisdiction	City of Umatilla				
Date Performed	11/18/2022	East/West Street	6th Street (US 730)				
Analysis Year	2022	North/South Street	Switzer Ave				
Time Analyzed	PM Pk Hr season adj	Peak Hour Factor	0.92				
Intersection Orientation	East-West	Analysis Time Period (hrs)	0.25				
Project Description	Umatilla Transportation System Plan						

Lanes

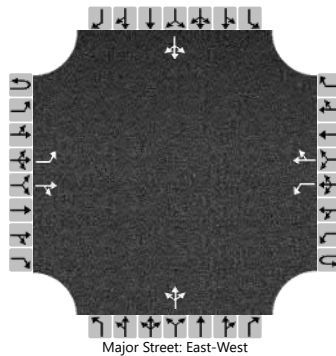

Vehicle Volumes and Adjustments

Approach	Eastbound				Westbound				Northbound				Southbound				
	U	L	T	R	U	L	T	R	U	L	T	R	U	L	T	R	
Movement	1U	1	2	3	4U	4	5	6		7	8	9		10	11	12	
Priority																	
Number of Lanes	0	1	1	0	0	1	1	0		0	1	0		0	1	0	
Configuration		L		TR		L		TR			LTR				LTR		
Volume (veh/h)		20	545	10		30	480	25		10	5	15		20	5	15	
Percent Heavy Vehicles (%)		3				3				3	3	3		3	3	3	
Proportion Time Blocked																	
Percent Grade (%)										0				0			
Right Turn Channelized																	
Median Type Storage	Undivided																

Critical and Follow-up Headways

Base Critical Headway (sec)		4.1				4.1				7.1	6.5	6.2		7.1	6.5	6.2
Critical Headway (sec)		4.13				4.13				7.13	6.53	6.23		7.13	6.53	6.23
Base Follow-Up Headway (sec)		2.2				2.2				3.5	4.0	3.3		3.5	4.0	3.3
Follow-Up Headway (sec)		2.23				2.23				3.53	4.03	3.33		3.53	4.03	3.33

Delay, Queue Length, and Level of Service

Flow Rate, v (veh/h)		22				33					33					43	
Capacity, c (veh/h)		1016				969					222					193	
v/c Ratio		0.02				0.03					0.15					0.23	
95% Queue Length, Q ₉₅ (veh)		0.1				0.1					0.5					0.8	
Control Delay (s/veh)		8.6				8.8					24.0					29.0	
Level of Service (LOS)		A				A					C					D	
Approach Delay (s/veh)		0.3				0.5				24.0				29.0			
Approach LOS										C				D			

HCS7 Two-Way Stop-Control Report

General Information		Site Information	
Analyst	Montgomery	Intersection	Umatilla River Rd/US 730
Agency/Co.	JUB Engineers	Jurisdiction	City of Umatilla
Date Performed	11/18/2022	East/West Street	6th Street (US 730)
Analysis Year	2022	North/South Street	Umat. Riv Rd (Cnty 1275)
Time Analyzed	PM Pk Hr season adj	Peak Hour Factor	0.92
Intersection Orientation	East-West	Analysis Time Period (hrs)	0.25
Project Description	Umatilla Transportation System Plan		

Lanes

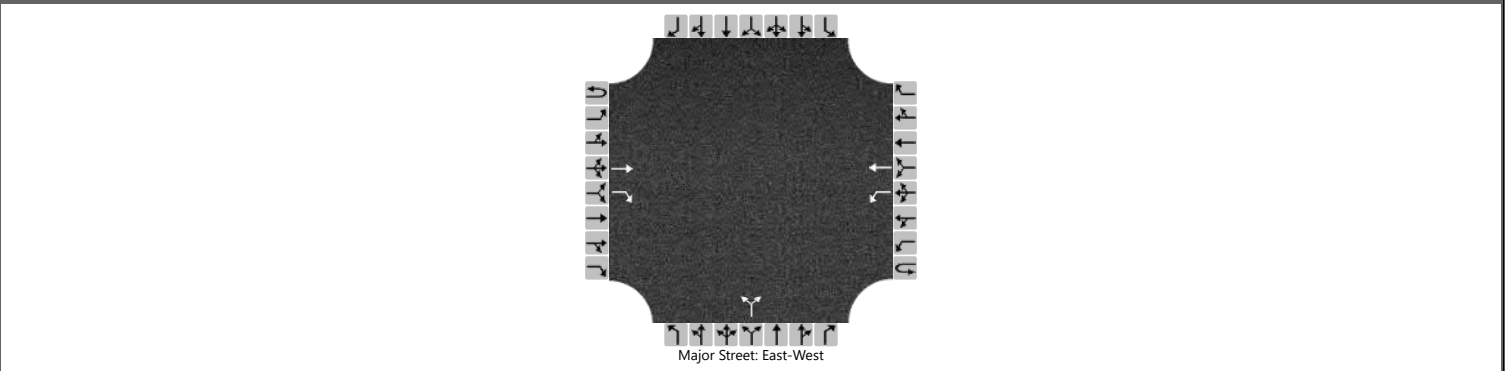

Vehicle Volumes and Adjustments

Approach	Eastbound				Westbound				Northbound				Southbound			
	U	L	T	R	U	L	T	R	U	L	T	R	U	L	T	R
Movement	1U	1	2	3	4U	4	5	6	7	8	9	10	11	12		
Priority																
Number of Lanes	0	0	1	1	0	1	1	0	0	1	0	0	0	0	0	
Configuration			T	R		L	T			LR						
Volume (veh/h)			485	155		105	455			125		90				
Percent Heavy Vehicles (%)						3				3		3				
Proportion Time Blocked																
Percent Grade (%)									0							
Right Turn Channelized	No															
Median Type Storage	Undivided															

Critical and Follow-up Headways

Base Critical Headway (sec)						4.1				7.1		6.2			
Critical Headway (sec)						4.13				6.43		6.23			
Base Follow-Up Headway (sec)						2.2				3.5		3.3			
Follow-Up Headway (sec)						2.23				3.53		3.33			

Delay, Queue Length, and Level of Service

Flow Rate, v (veh/h)						114					234					
Capacity, c (veh/h)						896					247					
v/c Ratio						0.13					0.95					
95% Queue Length, Q ₉₅ (veh)						0.4					8.6					
Control Delay (s/veh)						9.6					87.4					
Level of Service (LOS)						A					F					
Approach Delay (s/veh)					1.8				87.4							
Approach LOS									F							

HCS7 Two-Way Stop-Control Report

General Information		Site Information	
Analyst	Montgomery	Intersection	Umatilla River Rd/US 730
Agency/Co.	JUB Engineers	Jurisdiction	City of Umatilla
Date Performed	11/18/2022	East/West Street	6th Street (US 730)
Analysis Year	2022	North/South Street	Umat. Riv Rd (Cnty 1275)
Time Analyzed	PM Pk Hr - mitigated	Peak Hour Factor	0.92
Intersection Orientation	East-West	Analysis Time Period (hrs)	0.25
Project Description	Umatilla Transportation System Plan		

Lanes

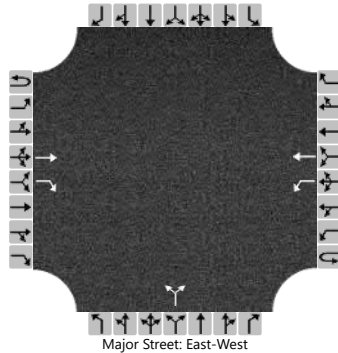

Vehicle Volumes and Adjustments

Approach	Eastbound				Westbound				Northbound				Southbound			
	U	L	T	R	U	L	T	R	U	L	T	R	U	L	T	R
Movement	1U	1	2	3	4U	4	5	6		7	8	9		10	11	12
Priority																
Number of Lanes	0	0	1	1	0	1	1	0		0	1	0		0	0	0
Configuration			T	R		L	T				LR					
Volume (veh/h)			485	155		105	455			125		90				
Percent Heavy Vehicles (%)						3				3		3				
Proportion Time Blocked																
Percent Grade (%)									0							
Right Turn Channelized	No															
Median Type Storage					Left Only								1			

Critical and Follow-up Headways

Base Critical Headway (sec)						4.1					7.1		6.2			
Critical Headway (sec)						4.13					6.43		6.23			
Base Follow-Up Headway (sec)						2.2					3.5		3.3			
Follow-Up Headway (sec)						2.23					3.53		3.33			

Delay, Queue Length, and Level of Service

Flow Rate, v (veh/h)						114					234					
Capacity, c (veh/h)						896					437					
v/c Ratio						0.13					0.53					
95% Queue Length, Q ₉₅ (veh)						0.4					3.1					
Control Delay (s/veh)						9.6					22.3					
Level of Service (LOS)						A					C					
Approach Delay (s/veh)					1.8				22.3							
Approach LOS									C							

Lanes, Volumes, Timings
5: 6th & Brownell

11/08/2022

Lane Group	EBL	EBT	EBR	WBL	WBT	WBR	NBL	NBT	NBR	SBL	SBT	SBR
Lane Configurations												
Traffic Volume (vph)	25	605	5	10	685	50	10	5	40	120	5	20
Future Volume (vph)	25	605	5	10	685	50	10	5	40	120	5	20
Ideal Flow (vphpl)	1900	1900	1900	1900	1900	1900	1900	1900	1900	1900	1900	1900
Storage Length (ft)	165		0	0		0	0		0	0		0
Storage Lanes	1		0	1		0	0		0	0		1
Taper Length (ft)	135			25			25			25		
Lane Util. Factor	1.00	0.95	0.95	1.00	0.95	0.95	1.00	1.00	1.00	1.00	1.00	1.00
Frt		0.999			0.990			0.902				0.850
Flt Protected	0.950			0.950				0.991			0.954	
Satd. Flow (prot)	1703	3402	0	1556	3081	0	0	1602	0	0	1119	997
Flt Permitted	0.950			0.950				0.954			0.693	
Satd. Flow (perm)	1703	3402	0	1556	3081	0	0	1542	0	0	813	997
Right Turn on Red			Yes			Yes			Yes			Yes
Satd. Flow (RTOR)		1			8			48				63
Link Speed (mph)		35			35			30				30
Link Distance (ft)		1078			236			248				460
Travel Time (s)		21.0			4.6			5.6				10.5
Peak Hour Factor	0.81	0.81	0.81	0.89	0.89	0.89	0.84	0.84	0.84	0.93	0.93	0.93
Heavy Vehicles (%)	6%	6%	6%	16%	16%	16%	6%	6%	6%	62%	62%	62%
Adj. Flow (vph)	31	747	6	11	770	56	12	6	48	129	5	22
Shared Lane Traffic (%)												
Lane Group Flow (vph)	31	753	0	11	826	0	0	66	0	0	134	22
Enter Blocked Intersection	No	No	No	No	No	No	No	No	No	No	No	No
Lane Alignment	Left	Left	Right	Left	Left	Right	Left	Left	Right	Left	Left	Right
Median Width(ft)		12			12			0				0
Link Offset(ft)		0			0			0				0
Crosswalk Width(ft)		16			16			16				16
Two way Left Turn Lane												
Headway Factor	1.00	1.00	1.00	1.00	1.00	1.00	1.00	1.00	1.00	1.00	1.00	1.00
Turning Speed (mph)	15		9	15		9	15		9	15		9
Number of Detectors	1	2		1	2		1	2		1	2	1
Detector Template	Left	Thru		Left	Thru		Left	Thru		Left	Thru	Right
Leading Detector (ft)	20	100		20	100		20	100		20	100	20
Trailing Detector (ft)	0	0		0	0		0	0		0	0	0
Detector 1 Position(ft)	0	0		0	0		0	0		0	0	0
Detector 1 Size(ft)	20	6		20	6		20	6		20	6	20
Detector 1 Type	Cl+Ex	Cl+Ex		Cl+Ex	Cl+Ex		Cl+Ex	Cl+Ex		Cl+Ex	Cl+Ex	Cl+Ex
Detector 1 Channel												
Detector 1 Extend (s)	0.0	0.0		0.0	0.0		0.0	0.0		0.0	0.0	0.0
Detector 1 Queue (s)	0.0	0.0		0.0	0.0		0.0	0.0		0.0	0.0	0.0
Detector 1 Delay (s)	0.0	0.0		0.0	0.0		0.0	0.0		0.0	0.0	0.0
Detector 2 Position(ft)		94			94			94				94
Detector 2 Size(ft)		6			6			6				6
Detector 2 Type		Cl+Ex			Cl+Ex			Cl+Ex				Cl+Ex
Detector 2 Channel												
Detector 2 Extend (s)		0.0			0.0			0.0				0.0
Turn Type	Prot	NA		Prot	NA		Perm	NA		Perm	NA	Perm
Protected Phases	1	6		5	2			4				8

Lanes, Volumes, Timings
5: 6th & Brownell

11/08/2022



Lane Group	EBL	EBT	EBR	WBL	WBT	WBR	NBL	NBT	NBR	SBL	SBT	SBR
Permitted Phases							4			8		8
Detector Phase	1	6		5	2		4	4		8	8	8
Switch Phase												
Minimum Initial (s)	7.0	10.0		7.0	10.0		7.0	7.0		7.0	7.0	7.0
Minimum Split (s)	13.0	39.5		13.0	36.5		36.5	36.5		44.5	44.5	44.5
Total Split (s)	19.5	39.5		19.5	39.5		44.5	44.5		44.5	44.5	44.5
Total Split (%)	18.8%	38.2%		18.8%	38.2%		43.0%	43.0%		43.0%	43.0%	43.0%
Maximum Green (s)	15.0	35.0		15.0	35.0		40.0	40.0		40.0	40.0	40.0
Yellow Time (s)	4.0	4.0		4.0	4.0		4.0	4.0		4.0	4.0	4.0
All-Red Time (s)	0.5	0.5		0.5	0.5		0.5	0.5		0.5	0.5	0.5
Lost Time Adjust (s)	0.0	0.0		0.0	0.0			0.0			0.0	0.0
Total Lost Time (s)	4.5	4.5		4.5	4.5			4.5			4.5	4.5
Lead/Lag	Lead	Lag		Lead	Lag							
Lead-Lag Optimize?	Yes	Yes		Yes	Yes							
Vehicle Extension (s)	3.5	5.6		3.5	4.6		3.5	3.5		5.0	5.0	5.0
Minimum Gap (s)	2.0	3.6		2.0	2.6		2.0	2.0		5.0	5.0	5.0
Time Before Reduce (s)	10.0	10.0		10.0	10.0		15.0	15.0		5.0	5.0	5.0
Time To Reduce (s)	10.0	10.0		10.0	10.0		15.0	15.0		5.0	5.0	5.0
Recall Mode	None	Min		None	Min		None	None		None	None	None
Walk Time (s)		7.0			7.0		7.0	7.0		7.0	7.0	7.0
Flash Dont Walk (s)		29.0			22.0		23.0	23.0		25.0	25.0	25.0
Pedestrian Calls (#/hr)		0			0		0	0		0	0	0
Act Effct Green (s)	8.4	34.2		10.1	38.3			29.9			29.9	29.9
Actuated g/C Ratio	0.10	0.40		0.12	0.45			0.35			0.35	0.35
v/c Ratio	0.18	0.55		0.06	0.59			0.11			0.47	0.06
Control Delay	44.0	24.3		57.1	14.9			8.9			29.1	0.2
Queue Delay	0.0	0.1		0.0	0.2			0.0			0.0	0.0
Total Delay	44.0	24.3		57.1	15.1			8.9			29.1	0.2
LOS	D	C		E	B			A			C	A
Approach Delay		25.1			15.6			8.9			25.0	
Approach LOS		C			B			A			C	
Queue Length 50th (ft)	17	171		6	83			7			58	0
Queue Length 95th (ft)	43	245		m21	313			30			120	0
Internal Link Dist (ft)		998			156			168			380	
Turn Bay Length (ft)	165											
Base Capacity (vph)	321	1499		293	1511			800			409	533
Starvation Cap Reductn	0	0		0	150			0			0	0
Spillback Cap Reductn	0	88		0	0			0			0	0
Storage Cap Reductn	0	0		0	0			0			0	0
Reduced v/c Ratio	0.10	0.53		0.04	0.61			0.08			0.33	0.04

Intersection Summary

Area Type: Other
 Cycle Length: 103.5
 Actuated Cycle Length: 84.8
 Natural Cycle: 100
 Control Type: Actuated-Uncoordinated
 Maximum v/c Ratio: 0.73
 Intersection Signal Delay: 20.2
 Intersection LOS: C

Lanes, Volumes, Timings

5: 6th & Brownell





11/08/2022

Intersection Capacity Utilization 43.4% ICU Level of Service A

Analysis Period (min) 15

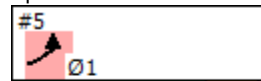
m Volume for 95th percentile queue is metered by upstream signal.

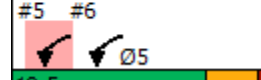
Splits and Phases: 5: 6th & Brownell

 <p>#5 Ø1</p>	 <p>#5 #6 Ø2</p>	 <p>#5 Ø4</p>
<p>19.5 s</p>	<p>39.5 s</p>	<p>44.5 s</p>
 <p>#5 #6 Ø5</p>	 <p>#5 #6 Ø6</p>	 <p>#5 #6 Ø8</p>
<p>19.5 s</p>	<p>39.5 s</p>	<p>44.5 s</p>

Lanes, Volumes, Timings

6: I-82 SB Entrance Ramp/I-82 SB Exit Ramp & 6th

11/08/2022



Lane Group	EBL	EBT	EBR	WBL	WBT	WBR	NBL	NBT	NBR	SBL	SBT	SBR
Lane Configurations		↑↑		↖	↑↑						↖	↖
Traffic Volume (vph)	0	660	110	65	400	0	0	0	0	310	5	340
Future Volume (vph)	0	660	110	65	400	0	0	0	0	310	5	340
Ideal Flow (vphpl)	1900	1900	1900	1900	1900	1900	1900	1900	1900	1900	1900	1900
Storage Length (ft)	0		0	110		0	0		0	0		0
Storage Lanes	0		0	1		0	0		0	0		1
Taper Length (ft)	25			45			25			25		
Lane Util. Factor	1.00	0.95	0.95	1.00	0.95	1.00	1.00	1.00	1.00	1.00	1.00	1.00
Frt		0.979										0.850
Flt Protected				0.950							0.953	
Satd. Flow (prot)	0	3047	0	1687	3374	0	0	0	0	0	1548	1380
Flt Permitted				0.950							0.953	
Satd. Flow (perm)	0	3047	0	1687	3374	0	0	0	0	0	1548	1380
Right Turn on Red			Yes			Yes			Yes			Yes
Satd. Flow (RTOR)		20										366
Link Speed (mph)		35			35			45				45
Link Distance (ft)		236			481			189				496
Travel Time (s)		4.6			9.4			2.9				7.5
Peak Hour Factor	0.85	0.85	0.85	0.91	0.91	0.91	0.92	0.92	0.92	0.93	0.93	0.93
Heavy Vehicles (%)	16%	16%	16%	7%	7%	7%	2%	2%	2%	17%	17%	17%
Adj. Flow (vph)	0	776	129	71	440	0	0	0	0	333	5	366
Shared Lane Traffic (%)												
Lane Group Flow (vph)	0	905	0	71	440	0	0	0	0	0	338	366
Enter Blocked Intersection	No	No	No	No	No	No	No	No	No	No	No	No
Lane Alignment	Left	Right	Right	Left	Right	R NA	Left	Left	Right	Left	Left	Right
Median Width(ft)		12			12			0				0
Link Offset(ft)		0			0			0				0
Crosswalk Width(ft)		16			16			16				16
Two way Left Turn Lane												
Headway Factor	1.00	1.00	1.00	1.00	1.00	1.00	1.00	1.00	1.00	1.00	1.00	1.00
Turning Speed (mph)	15		9	15		9	15		9	15		9
Number of Detectors		2		1	2					1	2	1
Detector Template		Thru		Left	Thru					Left	Thru	Right
Leading Detector (ft)		100		20	100					20	100	20
Trailing Detector (ft)		0		0	0					0	0	0
Detector 1 Position(ft)		0		0	0					0	0	0
Detector 1 Size(ft)		6		20	6					20	6	20
Detector 1 Type		Cl+Ex		Cl+Ex	Cl+Ex					Cl+Ex	Cl+Ex	Cl+Ex
Detector 1 Channel												
Detector 1 Extend (s)		0.0		0.0	0.0					0.0	0.0	0.0
Detector 1 Queue (s)		0.0		0.0	0.0					0.0	0.0	0.0
Detector 1 Delay (s)		0.0		0.0	0.0					0.0	0.0	0.0
Detector 2 Position(ft)		94			94							94
Detector 2 Size(ft)		6			6							6
Detector 2 Type		Cl+Ex			Cl+Ex							Cl+Ex
Detector 2 Channel												
Detector 2 Extend (s)		0.0			0.0							0.0
Turn Type		NA		Prot	NA					Perm	NA	Perm
Protected Phases		6		5	2							8

Lanes, Volumes, Timings
 6: I-82 SB Entrance Ramp/I-82 SB Exit Ramp & 6th

11/08/2022



Lane Group	EBL	EBT	EBR	WBL	WBT	WBR	NBL	NBT	NBR	SBL	SBT	SBR
Permitted Phases										8		8
Detector Phase		6		5	2					8	8	8
Switch Phase												
Minimum Initial (s)		10.0		7.0	10.0					7.0	7.0	7.0
Minimum Split (s)		39.5		13.0	36.5					44.5	44.5	44.5
Total Split (s)		39.5		19.5	39.5					44.5	44.5	44.5
Total Split (%)		38.2%		18.8%	38.2%					43.0%	43.0%	43.0%
Maximum Green (s)		35.0		15.0	35.0					40.0	40.0	40.0
Yellow Time (s)		4.0		4.0	4.0					4.0	4.0	4.0
All-Red Time (s)		0.5		0.5	0.5					0.5	0.5	0.5
Lost Time Adjust (s)		0.0		0.0	0.0						0.0	0.0
Total Lost Time (s)		4.5		4.5	4.5						4.5	4.5
Lead/Lag		Lag		Lead	Lag							
Lead-Lag Optimize?		Yes		Yes	Yes							
Vehicle Extension (s)		5.6		3.5	4.6					5.0	5.0	5.0
Minimum Gap (s)		3.6		2.0	2.6					5.0	5.0	5.0
Time Before Reduce (s)		10.0		10.0	10.0					5.0	5.0	5.0
Time To Reduce (s)		10.0		10.0	10.0					5.0	5.0	5.0
Recall Mode		Min		None	Min					None	None	None
Walk Time (s)		7.0			7.0					7.0	7.0	7.0
Flash Dont Walk (s)		29.0			22.0					25.0	25.0	25.0
Pedestrian Calls (#/hr)		0			0					0	0	0
Act Effct Green (s)		34.2		10.1	38.3						29.9	29.9
Actuated g/C Ratio		0.40		0.12	0.45						0.35	0.35
v/c Ratio		0.73		0.35	0.29						0.62	0.51
Control Delay		14.4		44.6	18.3						29.3	5.0
Queue Delay		0.0		0.0	0.0						0.0	0.0
Total Delay		14.4		44.6	18.4						29.3	5.0
LOS		B		D	B						C	A
Approach Delay		14.4			22.0						16.7	
Approach LOS		B			C						B	
Queue Length 50th (ft)		61		38	85						156	0
Queue Length 95th (ft)		80		86	147						260	57
Internal Link Dist (ft)		156			401			109			416	
Turn Bay Length (ft)				110								
Base Capacity (vph)		1353		318	1650						779	876
Starvation Cap Reductn		2		0	0						0	0
Spillback Cap Reductn		0		0	134						0	14
Storage Cap Reductn		0		0	0						0	0
Reduced v/c Ratio		0.67		0.22	0.29						0.43	0.42

Intersection Summary

Area Type:	Other
Cycle Length:	103.5
Actuated Cycle Length:	84.8
Natural Cycle:	100
Control Type:	Actuated-Uncoordinated
Maximum v/c Ratio:	0.73
Intersection Signal Delay:	17.0
Intersection LOS:	B

Lanes, Volumes, Timings
 6: I-82 SB Entrance Ramp/I-82 SB Exit Ramp & 6th

11/08/2022

Lane Group	Ø1	Ø4
Permitted Phases		
Detector Phase		
Switch Phase		
Minimum Initial (s)	7.0	7.0
Minimum Split (s)	13.0	36.5
Total Split (s)	19.5	44.5
Total Split (%)	19%	43%
Maximum Green (s)	15.0	40.0
Yellow Time (s)	4.0	4.0
All-Red Time (s)	0.5	0.5
Lost Time Adjust (s)		
Total Lost Time (s)		
Lead/Lag	Lead	
Lead-Lag Optimize?	Yes	
Vehicle Extension (s)	3.5	3.5
Minimum Gap (s)	2.0	2.0
Time Before Reduce (s)	10.0	15.0
Time To Reduce (s)	10.0	15.0
Recall Mode	None	None
Walk Time (s)		7.0
Flash Dont Walk (s)		23.0
Pedestrian Calls (#/hr)		0
Act Effct Green (s)		
Actuated g/C Ratio		
v/c Ratio		
Control Delay		
Queue Delay		
Total Delay		
LOS		
Approach Delay		
Approach LOS		
Queue Length 50th (ft)		
Queue Length 95th (ft)		
Internal Link Dist (ft)		
Turn Bay Length (ft)		
Base Capacity (vph)		
Starvation Cap Reductn		
Spillback Cap Reductn		
Storage Cap Reductn		
Reduced v/c Ratio		
Intersection Summary		

Lanes, Volumes, Timings

6: I-82 SB Entrance Ramp/I-82 SB Exit Ramp & 6th







11/08/2022

Intersection Capacity Utilization 56.3%

ICU Level of Service B

Analysis Period (min) 15

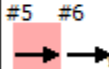

















Splits and Phases: 6: I-82 SB Entrance Ramp/I-82 SB Exit Ramp & 6th

 <p>#5 Ø1</p>	 <p>#5 #6 Ø2</p>	 <p>#5 Ø4</p>
<p>19.5 s</p>	<p>39.5 s</p>	<p>44.5 s</p>
 <p>#5 #6 Ø5</p>	 <p>#5 #6 Ø6</p>	 <p>#5 #6 Ø8</p>
<p>19.5 s</p>	<p>39.5 s</p>	<p>44.5 s</p>

Lanes, Volumes, Timings





















7: I-82 NB Exit Ramp/I-82 NB Entrance Ramp & 6th

11/08/2022

												
Lane Group	EBL	EBT	EBR	WBL	WBT	WBR	NBL	NBT	NBR	SBL	SBT	SBR
Lane Configurations		 			 							
Traffic Volume (vph)	305	665	0	0	440	470	30	5	125	0	0	0
Future Volume (vph)	305	665	0	0	440	470	30	5	125	0	0	0
Ideal Flow (vphpl)	1900	1900	1900	1900	1900	1900	1900	1900	1900	1900	1900	1900
Storage Length (ft)	110		0	0		0	0		215	0		0
Storage Lanes	1		0	0		0	0		1	0		0
Taper Length (ft)	70			25			25			25		
Lane Util. Factor	1.00	0.95	1.00	1.00	0.95	0.95	1.00	1.00	1.00	1.00	1.00	1.00
Frt					0.923				0.850			
Flt Protected	0.950							0.959				
Satd. Flow (prot)	1719	3438	0	0	3173	0	0	1481	1313	0	0	0
Flt Permitted	0.950							0.959				
Satd. Flow (perm)	1719	3438	0	0	3173	0	0	1481	1313	0	0	0
Link Speed (mph)		35			45			45				45
Link Distance (ft)		481			3338			681				572
Travel Time (s)		9.4			50.6			10.3				8.7
Peak Hour Factor	0.80	0.80	0.80	0.85	0.85	0.85	0.82	0.82	0.82	0.92	0.92	0.92
Heavy Vehicles (%)	5%	5%	5%	5%	5%	5%	23%	23%	23%	2%	2%	2%
Adj. Flow (vph)	381	831	0	0	518	553	37	6	152	0	0	0
Shared Lane Traffic (%)												
Lane Group Flow (vph)	381	831	0	0	1071	0	0	43	152	0	0	0
Enter Blocked Intersection	No	No	No	No	No	No	No	No	No	No	No	No
Lane Alignment	Left	Left	Right	Left	Left	Right	Left	Left	Right	Left	Left	Right
Median Width(ft)		12			12			0				0
Link Offset(ft)		0			0			0				0
Crosswalk Width(ft)		16			16			16				16
Two way Left Turn Lane												
Headway Factor	1.00	1.00	1.00	1.00	1.00	1.00	1.00	1.00	1.00	1.00	1.00	1.00
Turning Speed (mph)	15		9	15		9	15		9	15		9
Sign Control		Free			Free			Stop				Stop
Intersection Summary												
Area Type:	Other											
Control Type:	Unsignalized											
Intersection Capacity Utilization	57.5%						ICU Level of Service B					
Analysis Period (min)	15											

Lanes, Volumes, Timings
8: Devore & 6th

11/08/2022

												
Lane Group	EBL	EBT	EBR	WBL	WBT	WBR	NBL	NBT	NBR	SBL	SBT	SBR
Lane Configurations												
Traffic Volume (vph)	5	275	0	245	380	5	470	10	250	5	15	40
Future Volume (vph)	5	275	0	245	380	5	470	10	250	5	15	40
Ideal Flow (vphpl)	1900	1900	1900	1900	1900	1900	1900	1900	1900	1900	1900	1900
Storage Length (ft)	125		0	145		0	0		0	0		0
Storage Lanes	1		0	1		0	0		1	0		0
Taper Length (ft)	60			88			25			25		
Lane Util. Factor	1.00	0.95	1.00	1.00	0.95	0.95	1.00	1.00	1.00	1.00	1.00	1.00
Frt					0.998				0.850		0.910	
Flt Protected	0.950			0.950				0.953			0.996	
Satd. Flow (prot)	1770	3539	0	1770	3532	0	0	1775	1583	0	1688	0
Flt Permitted	0.950			0.950				0.621			0.933	
Satd. Flow (perm)	1770	3539	0	1770	3532	0	0	1157	1583	0	1582	0
Right Turn on Red			Yes			Yes			Yes			Yes
Satd. Flow (RTOR)					2				257		90	
Link Speed (mph)		45			45			45			45	
Link Distance (ft)		343			889			455			382	
Travel Time (s)		5.2			13.5			6.9			5.8	
Peak Hour Factor	0.82	0.82	0.82	0.72	0.72	0.72	0.90	0.90	0.90	0.42	0.42	0.42
Adj. Flow (vph)	6	335	0	340	528	7	522	11	278	12	36	95
Shared Lane Traffic (%)												
Lane Group Flow (vph)	6	335	0	340	535	0	0	533	278	0	143	0
Enter Blocked Intersection	No	No	No	No	No	No	No	No	No	No	No	No
Lane Alignment	Left	Left	Right	Left	Left	Right	Left	Left	Right	Left	Left	Right
Median Width(ft)		12			12			0			0	
Link Offset(ft)		0			0			0			0	
Crosswalk Width(ft)		16			16			16			16	
Two way Left Turn Lane												
Headway Factor	1.00	1.00	1.00	1.00	1.00	1.00	1.00	1.00	1.00	1.00	1.00	1.00
Turning Speed (mph)	15		9	15		9	15		9	15		9
Number of Detectors	1	2		1	2		1	2	1	1	2	
Detector Template	Left	Thru		Left	Thru		Left	Thru	Right	Left	Thru	
Leading Detector (ft)	20	100		20	100		20	100	20	20	100	
Trailing Detector (ft)	0	0		0	0		0	0	0	0	0	
Detector 1 Position(ft)	0	0		0	0		0	0	0	0	0	
Detector 1 Size(ft)	20	6		20	6		20	6	20	20	6	
Detector 1 Type	Cl+Ex	Cl+Ex		Cl+Ex	Cl+Ex		Cl+Ex	Cl+Ex	Cl+Ex	Cl+Ex	Cl+Ex	
Detector 1 Channel												
Detector 1 Extend (s)	0.0	0.0		0.0	0.0		0.0	0.0	0.0	0.0	0.0	
Detector 1 Queue (s)	0.0	0.0		0.0	0.0		0.0	0.0	0.0	0.0	0.0	
Detector 1 Delay (s)	0.0	0.0		0.0	0.0		0.0	0.0	0.0	0.0	0.0	
Detector 2 Position(ft)		94			94			94			94	
Detector 2 Size(ft)		6			6			6			6	
Detector 2 Type		Cl+Ex			Cl+Ex			Cl+Ex			Cl+Ex	
Detector 2 Channel												
Detector 2 Extend (s)		0.0			0.0			0.0			0.0	
Turn Type	Prot	NA		Prot	NA		Perm	NA	Perm	Perm	NA	
Protected Phases	5	2		1	6			8			4	
Permitted Phases							8		8	4		

Lanes, Volumes, Timings
8: Devore & 6th

11/08/2022



Lane Group	EBL	EBT	EBR	WBL	WBT	WBR	NBL	NBT	NBR	SBL	SBT	SBR
Detector Phase	5	2		1	6		8	8	8	4	4	
Switch Phase												
Minimum Initial (s)	8.0	10.0		8.0	10.0		8.0	8.0	8.0	7.0	7.0	
Minimum Split (s)	13.0	36.5		13.0	31.5		46.5	46.5	46.5	36.5	36.5	
Total Split (s)	14.5	35.5		39.5	35.5		40.5	40.5	40.5	19.5	19.5	
Total Split (%)	12.6%	30.7%		34.2%	30.7%		35.1%	35.1%	35.1%	16.9%	16.9%	
Maximum Green (s)	10.0	30.0		35.0	30.0		35.0	35.0	35.0	15.0	15.0	
Yellow Time (s)	4.0	5.0		4.0	5.0		5.0	5.0	5.0	4.0	4.0	
All-Red Time (s)	0.5	0.5		0.5	0.5		0.5	0.5	0.5	0.5	0.5	
Lost Time Adjust (s)	0.0	0.0		0.0	0.0			0.0	0.0		0.0	
Total Lost Time (s)	4.5	5.5		4.5	5.5			5.5	5.5		4.5	
Lead/Lag	Lead	Lag		Lead	Lag							
Lead-Lag Optimize?	Yes	Yes		Yes	Yes							
Vehicle Extension (s)	2.5	7.0		3.5	5.4		3.5	3.5	3.5	2.5	2.5	
Minimum Gap (s)	1.0	3.4		2.5	3.4		1.5	1.5	1.5	1.0	1.0	
Time Before Reduce (s)	5.0	15.0		5.0	15.0		10.0	10.0	10.0	5.0	5.0	
Time To Reduce (s)	5.0	15.0		5.0	15.0		10.0	10.0	10.0	5.0	5.0	
Recall Mode	None	Min		None	Min		None	None	None	None	None	
Walk Time (s)		7.0			7.0		7.0	7.0	7.0	7.0	7.0	
Flash Dont Walk (s)		24.0			19.0		34.0	34.0	34.0	25.0	25.0	
Pedestrian Calls (#/hr)		0			0		0	0	0	0	0	
Act Effct Green (s)	8.1	18.4		23.3	44.1			35.4	35.4		36.4	
Actuated g/C Ratio	0.09	0.20		0.25	0.48			0.38	0.38		0.39	
v/c Ratio	0.04	0.48		0.77	0.32			1.21	0.36		0.21	
Control Delay	44.6	36.1		44.4	15.8			142.9	5.7		10.4	
Queue Delay	0.0	0.0		0.0	0.0			0.0	0.0		0.0	
Total Delay	44.6	36.1		44.4	15.8			142.9	5.7		10.4	
LOS	D	D		D	B			F	A		B	
Approach Delay		36.3			26.9			95.8			10.4	
Approach LOS		D			C			F			B	
Queue Length 50th (ft)	3	91		185	91			~386	8		19	
Queue Length 95th (ft)	16	135		220	123			#698	69		8	
Internal Link Dist (ft)		263			809			375			302	
Turn Bay Length (ft)	125			145								
Base Capacity (vph)	192	1157		675	2118			441	762		675	
Starvation Cap Reductn	0	0		0	0			0	0		0	
Spillback Cap Reductn	0	0		0	0			0	0		0	
Storage Cap Reductn	0	0		0	0			0	0		0	
Reduced v/c Ratio	0.03	0.29		0.50	0.25			1.21	0.36		0.21	

Intersection Summary	
Area Type:	Other
Cycle Length:	115.5
Actuated Cycle Length:	92.8
Natural Cycle:	130
Control Type:	Actuated-Uncoordinated
Maximum v/c Ratio:	1.21
Intersection Signal Delay:	53.1
Intersection LOS:	D
Intersection Capacity Utilization:	68.1%
ICU Level of Service:	C

Lanes, Volumes, Timings

8: Devore & 6th

11/08/2022

Analysis Period (min) 15

~ Volume exceeds capacity, queue is theoretically infinite.

Queue shown is maximum after two cycles.

95th percentile volume exceeds capacity, queue may be longer.

Queue shown is maximum after two cycles.

Splits and Phases: 8: Devore & 6th

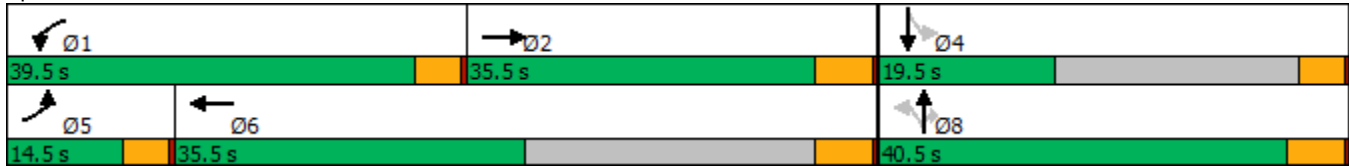

Lanes, Volumes, Timings

12: 6th

11/08/2022

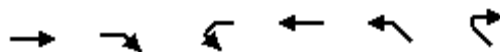

Lane Group	EBT	EBR	WBL	WBT	NWL	NWR
Lane Configurations	↑↑			↑↑		
Traffic Volume (vph)	280	445	0	890	0	0
Future Volume (vph)	280	445	0	890	0	0
Ideal Flow (vphpl)	1900	1900	1900	1900	1900	1900
Lane Util. Factor	0.95	0.95	1.00	0.95	1.00	1.00
Frt	0.908					
Flt Protected						
Satd. Flow (prot)	3007	0	0	3438	0	0
Flt Permitted						
Satd. Flow (perm)	3007	0	0	3438	0	0
Link Speed (mph)	45			45	45	
Link Distance (ft)	3338			343	639	
Travel Time (s)	50.6			5.2	9.7	
Peak Hour Factor	0.82	0.82	0.72	0.72	0.92	0.92
Heavy Vehicles (%)	9%	9%	5%	5%	2%	2%
Adj. Flow (vph)	341	543	0	1236	0	0
Shared Lane Traffic (%)						
Lane Group Flow (vph)	884	0	0	1236	0	0
Enter Blocked Intersection	No	No	No	No	No	No
Lane Alignment	Left	Right	Left	Left	Left	Right
Median Width(ft)	12			12	0	
Link Offset(ft)	0			0	0	
Crosswalk Width(ft)	16			16	16	
Two way Left Turn Lane						
Headway Factor	1.00	1.00	1.00	1.00	1.00	1.00
Turning Speed (mph)	9		15	15		9
Sign Control	Free			Free	Free	







Intersection Summary

Area Type:	Other
Control Type:	Unsignalized
Intersection Capacity Utilization	27.9%
	ICU Level of Service A
Analysis Period (min)	15

Lanes, Volumes, Timings

13: Devore

11/08/2022

						
Lane Group	NBL	NBT	SBT	SBR	SEL	SER
Lane Configurations		↑↑	↑			↗
Traffic Volume (vph)	0	649	232	0	0	397
Future Volume (vph)	0	649	232	0	0	397
Ideal Flow (vphpl)	1900	1900	1900	1900	1900	1900
Lane Util. Factor	1.00	0.95	1.00	1.00	1.00	1.00
Fr _t						0.865
Fl _t Protected						
Satd. Flow (prot)	0	3471	1827	0	0	1508
Fl _t Permitted						
Satd. Flow (perm)	0	3471	1827	0	0	1508
Link Speed (mph)		45	45		45	
Link Distance (ft)		235	455		639	
Travel Time (s)		3.6	6.9		9.7	
Peak Hour Factor	0.90	0.90	0.92	0.92	0.82	0.82
Heavy Vehicles (%)	4%	4%	4%	4%	9%	9%
Adj. Flow (vph)	0	721	252	0	0	484
Shared Lane Traffic (%)						
Lane Group Flow (vph)	0	721	252	0	0	484
Enter Blocked Intersection	No	No	No	No	No	No
Lane Alignment	Left	Left	L NA	Right	Left	R NA
Median Width(ft)		0	0		0	
Link Offset(ft)		0	0		0	
Crosswalk Width(ft)		16	16		16	
Two way Left Turn Lane						
Headway Factor	1.00	1.00	1.00	1.00	1.00	1.00
Turning Speed (mph)	15			9	15	9
Sign Control		Free	Free		Free	
Intersection Summary						
Area Type:	Other					
Control Type:	Unsignalized					
Intersection Capacity Utilization	43.5%			ICU Level of Service A		
Analysis Period (min)	15					

Intersection												
Int Delay, s/veh	19.8											
Movement	EBL	EBT	EBR	WBL	WBT	WBR	NBL	NBT	NBR	SBL	SBT	SBR
Lane Configurations	↘	↑↑			↑↑			↘	↗			
Traffic Vol, veh/h	305	665	0	0	440	470	30	5	125	0	0	0
Future Vol, veh/h	305	665	0	0	440	470	30	5	125	0	0	0
Conflicting Peds, #/hr	0	0	0	0	0	0	0	0	0	0	0	0
Sign Control	Free	Free	Free	Free	Free	Free	Stop	Stop	Stop	Stop	Stop	Stop
RT Channelized	-	-	None	-	-	None	-	-	None	-	-	None
Storage Length	110	-	-	-	-	-	-	-	215	-	-	-
Veh in Median Storage, #	-	0	-	-	0	-	-	0	-	-	0	-
Grade, %	-	0	-	-	0	-	-	0	-	-	0	-
Peak Hour Factor	80	80	80	85	85	85	82	82	82	92	92	92
Heavy Vehicles, %	5	5	5	5	5	5	23	23	23	2	2	2
Mvmt Flow	381	831	0	0	518	553	37	6	152	0	0	0

Major/Minor	Major1	Major2	Minor1
Conflicting Flow All	1071	0	- - - 0 1852 2664 416
Stage 1	-	-	- - - 1593 1593 -
Stage 2	-	-	- - - 259 1071 -
Critical Hdwy	4.2	-	- - - 7.26 6.96 7.36
Critical Hdwy Stg 1	-	-	- - - 6.26 5.96 -
Critical Hdwy Stg 2	-	-	- - - 6.26 5.96 -
Follow-up Hdwy	2.25	-	- - - 3.73 4.23 3.53
Pot Cap-1 Maneuver	629	- 0 0	- - 52 16 531
Stage 1	-	- 0 0	- - 124 135 -
Stage 2	-	- 0 0	- - 701 254 -
Platoon blocked, %	-	-	- -
Mov Cap-1 Maneuver	629	- - -	- ~ 20 0 531
Mov Cap-2 Maneuver	-	- - -	- ~ 20 0 -
Stage 1	-	- - -	- 49 0 -
Stage 2	-	- - -	- 701 0 -

Approach	EB	WB	NB
HCM Control Delay, s	6	0	214.3
HCM LOS			F

Minor Lane/Major Mvmt	NBLn1	NBLn2	EBL	EBT	WBT	WBR
Capacity (veh/h)	20	531	629	-	-	-
HCM Lane V/C Ratio	2.134	0.287	0.606	-	-	-
HCM Control Delay (s)	\$ 928	14.5	19.1	-	-	-
HCM Lane LOS	F	B	C	-	-	-
HCM 95th %tile Q(veh)	5.7	1.2	4.1	-	-	-

Notes
 ~: Volume exceeds capacity \$: Delay exceeds 300s +: Computation Not Defined *: All major volume in platoon

HCS7 Two-Way Stop-Control Report

General Information		Site Information	
Analyst	Montgomery	Intersection	Columbia Blvd/US 730
Agency/Co.	JUB Engineers	Jurisdiction	City of Umatilla
Date Performed	11/18/2022	East/West Street	6th Street (US 730)
Analysis Year	2022	North/South Street	Columbia Blvd
Time Analyzed	PM Pk Hr - season adj	Peak Hour Factor	0.81
Intersection Orientation	East-West	Analysis Time Period (hrs)	0.25
Project Description	Umatilla Transportation System Plan		

Lanes

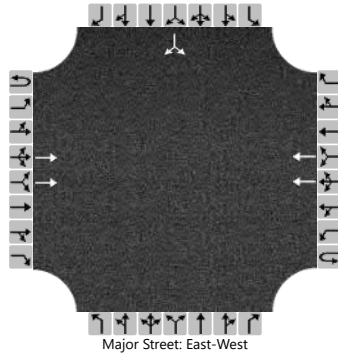

Vehicle Volumes and Adjustments

Approach	Eastbound				Westbound				Northbound				Southbound			
	U	L	T	R	U	L	T	R	U	L	T	R	U	L	T	R
Movement	1U	1	2	3	4U	4	5	6		7	8	9		10	11	12
Priority																
Number of Lanes	0	0	2	0	0	0	2	0	0	0	0	0	0	0	1	0
Configuration			T				T								LR	
Volume (veh/h)			495				540							5		130
Percent Heavy Vehicles (%)														3		3
Proportion Time Blocked																
Percent Grade (%)														0		
Right Turn Channelized																
Median Type Storage	Undivided															

Critical and Follow-up Headways

Base Critical Headway (sec)														7.5		6.9
Critical Headway (sec)														6.86		6.96
Base Follow-Up Headway (sec)														3.5		3.3
Follow-Up Headway (sec)														3.53		3.33

Delay, Queue Length, and Level of Service

Flow Rate, v (veh/h)																167
Capacity, c (veh/h)																621
v/c Ratio																0.27
95% Queue Length, Q ₉₅ (veh)																1.1
Control Delay (s/veh)																12.9
Level of Service (LOS)																B
Approach Delay (s/veh)																12.9
Approach LOS																B

HCS7 Two-Way Stop-Control Report

General Information		Site Information	
Analyst	Montgomery	Intersection	Willamette/US 730
Agency/Co.	JUB Engineers	Jurisdiction	City of Umatilla
Date Performed	11/18/2022	East/West Street	6th Street (US 730)
Analysis Year	2022	North/South Street	Willamette St
Time Analyzed	PM Pk Hr season adj	Peak Hour Factor	0.83
Intersection Orientation	East-West	Analysis Time Period (hrs)	0.25
Project Description	Umatilla Transportation System Plan		

Lanes

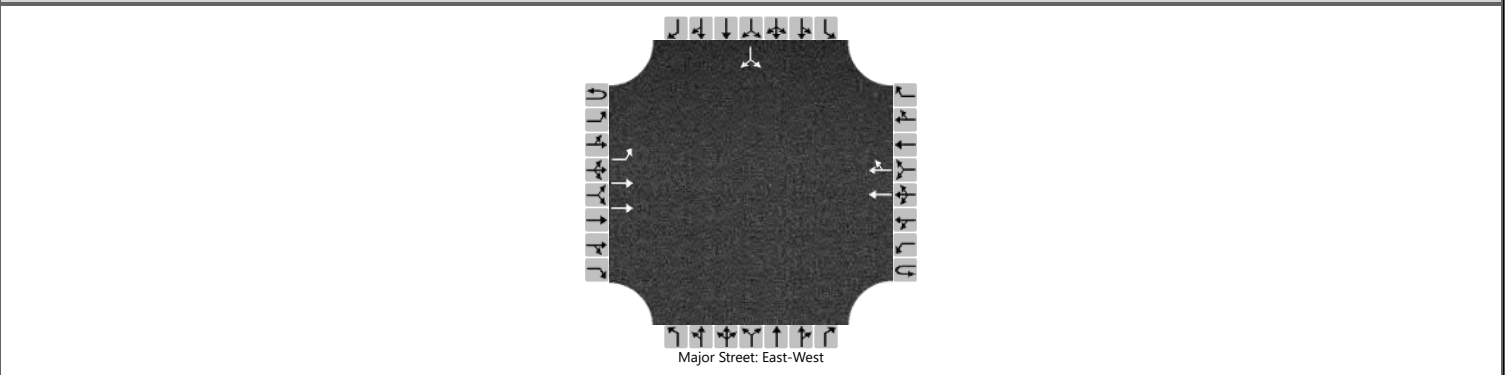

Vehicle Volumes and Adjustments

Approach	Eastbound				Westbound				Northbound				Southbound			
	U	L	T	R	U	L	T	R	U	L	T	R	U	L	T	R
Movement	1U	1	2	3	4U	4	5	6		7	8	9		10	11	12
Priority																
Number of Lanes	0	1	2	0	0	0	2	0	0	0	0	0	0	1	0	
Configuration		L	T				T	TR							LR	
Volume (veh/h)	0	340	160				380	80						30		165
Percent Heavy Vehicles (%)	3	3												3		3
Proportion Time Blocked																
Percent Grade (%)													0			
Right Turn Channelized																
Median Type Storage	Undivided															

Critical and Follow-up Headways

Base Critical Headway (sec)		4.1												7.5		6.9
Critical Headway (sec)		4.16												6.86		6.96
Base Follow-Up Headway (sec)		2.2												3.5		3.3
Follow-Up Headway (sec)		2.23												3.53		3.33

Delay, Queue Length, and Level of Service

Flow Rate, v (veh/h)		410													235	
Capacity, c (veh/h)		1005													308	
v/c Ratio		0.41													0.76	
95% Queue Length, Q ₉₅ (veh)		2.0													5.9	
Control Delay (s/veh)		11.0													46.0	
Level of Service (LOS)		B													E	
Approach Delay (s/veh)	7.5												46.0			
Approach LOS													E			

HCS7 Two-Way Stop-Control Report

General Information				Site Information			
Analyst	Montgomery	Intersection	Willamette/US 730				
Agency/Co.	JUB Engineers	Jurisdiction	City of Umatilla				
Date Performed	11/18/2022	East/West Street	6th Street (US 730)				
Analysis Year	2022	North/South Street	Willamette St				
Time Analyzed	PM Pk Hr mitigated	Peak Hour Factor	0.83				
Intersection Orientation	East-West	Analysis Time Period (hrs)	0.25				
Project Description	Umatilla Transportation System Plan						

Lanes

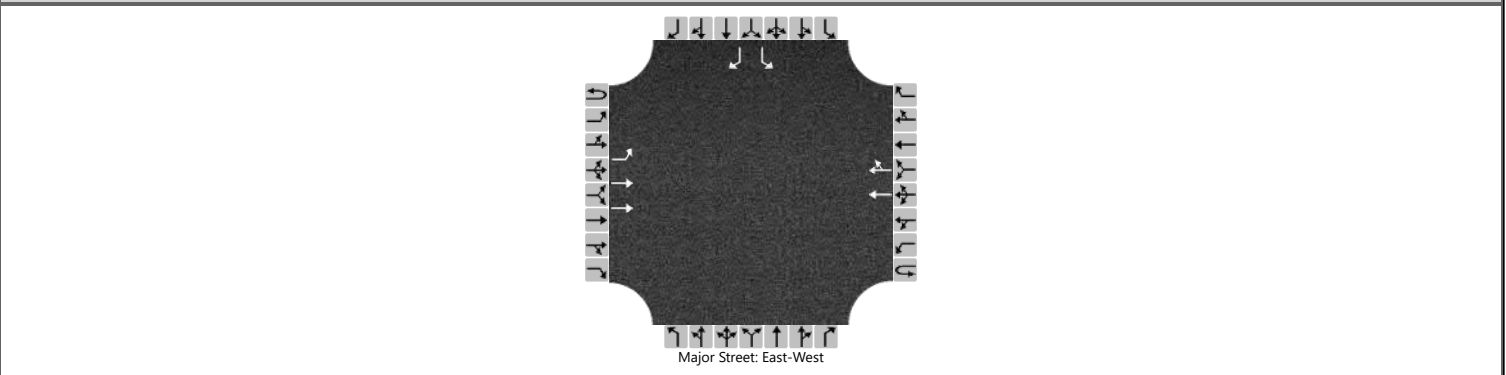

Vehicle Volumes and Adjustments

Approach	Eastbound				Westbound				Northbound				Southbound			
	U	L	T	R	U	L	T	R	U	L	T	R	U	L	T	R
Movement	1U	1	2	3	4U	4	5	6		7	8	9		10	11	12
Priority																
Number of Lanes	0	1	2	0	0	0	2	0	0	0	0		1	0	1	
Configuration		L	T				T	TR					L		R	
Volume (veh/h)	0	340	160				380	80					30		165	
Percent Heavy Vehicles (%)	3	3											3		3	
Proportion Time Blocked																
Percent Grade (%)													0			
Right Turn Channelized													No			
Median Type Storage	Undivided															

Critical and Follow-up Headways

Base Critical Headway (sec)		4.1												7.5		6.9
Critical Headway (sec)		4.16												6.86		6.96
Base Follow-Up Headway (sec)		2.2												3.5		3.3
Follow-Up Headway (sec)		2.23												3.53		3.33

Delay, Queue Length, and Level of Service

Flow Rate, v (veh/h)		410												36		199	
Capacity, c (veh/h)		1005												75		717	
v/c Ratio		0.41												0.48		0.28	
95% Queue Length, Q ₉₅ (veh)		2.0												2.0		1.1	
Control Delay (s/veh)		11.0												92.1		11.9	
Level of Service (LOS)		B												F		B	
Approach Delay (s/veh)		7.5												24.3			
Approach LOS														C			

HCS7 Two-Way Stop-Control Report

General Information		Site Information	
Analyst	Montgomery	Intersection	Bud Draper Rd/US 730
Agency/Co.	JUB Engineers	Jurisdiction	City of Umatilla
Date Performed	11/18/2022	East/West Street	6th Street (US 730)
Analysis Year	2022	North/South Street	Bud Draper Rd
Time Analyzed	PM Pk Hr - season adj	Peak Hour Factor	0.82
Intersection Orientation	East-West	Analysis Time Period (hrs)	0.25
Project Description	Umatilla Transportation System Plan		

Lanes

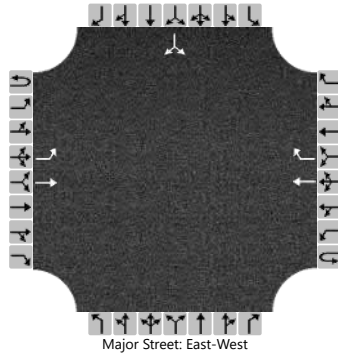

Vehicle Volumes and Adjustments

Approach	Eastbound				Westbound				Northbound				Southbound			
	U	L	T	R	U	L	T	R	U	L	T	R	U	L	T	R
Movement	1U	1	2	3	4U	4	5	6	7	8	9		10	11	12	
Priority																
Number of Lanes	0	1	1	0	0	0	1	1	0	0	0		0	1	0	
Configuration		L	T				T	R							LR	
Volume (veh/h)		10	180				410	5					10		40	
Percent Heavy Vehicles (%)		3											3		3	
Proportion Time Blocked																
Percent Grade (%)													0			
Right Turn Channelized					No											
Median Type Storage	Undivided															

Critical and Follow-up Headways

Base Critical Headway (sec)		4.1												7.1		6.2
Critical Headway (sec)		4.13												6.43		6.23
Base Follow-Up Headway (sec)		2.2												3.5		3.3
Follow-Up Headway (sec)		2.23												3.53		3.33

Delay, Queue Length, and Level of Service

Flow Rate, v (veh/h)		12													61	
Capacity, c (veh/h)		1054													516	
v/c Ratio		0.01													0.12	
95% Queue Length, Q ₉₅ (veh)		0.0													0.4	
Control Delay (s/veh)		8.5													12.9	
Level of Service (LOS)		A													B	
Approach Delay (s/veh)	0.4												12.9			
Approach LOS													B			

HCS7 Two-Way Stop-Control Report

General Information		Site Information	
Analyst	Montgomery	Intersection	Beach Access Rd/US 730
Agency/Co.	JUB Engineers	Jurisdiction	City of Umatilla
Date Performed	11/18/2022	East/West Street	6th Street (US 730)
Analysis Year	2022	North/South Street	Beach Access Rd
Time Analyzed	PM Pk Hr - season adj	Peak Hour Factor	0.79
Intersection Orientation	East-West	Analysis Time Period (hrs)	0.25
Project Description	Umatilla Transportation System Plan		

Lanes

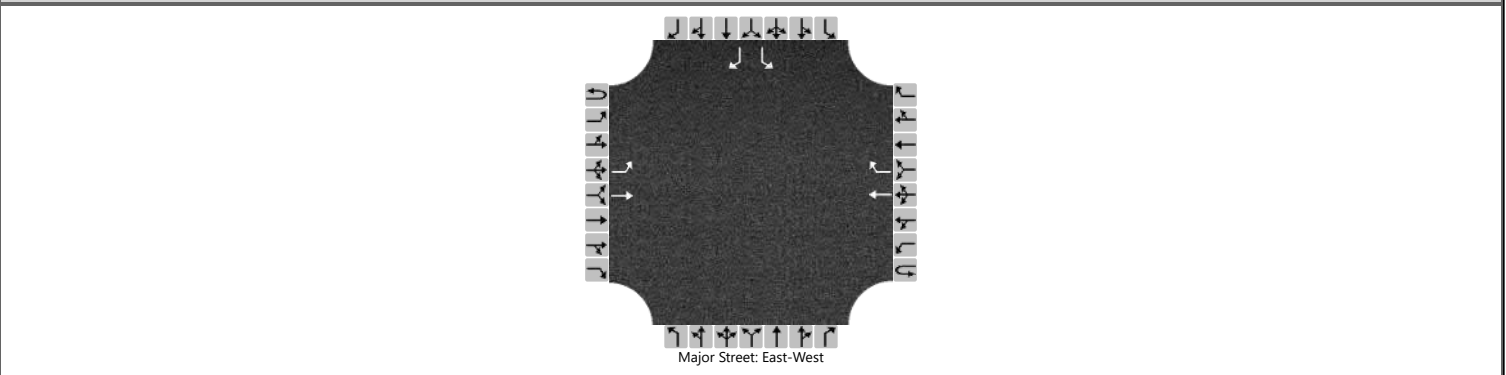

Vehicle Volumes and Adjustments

Approach	Eastbound				Westbound				Northbound				Southbound			
	U	L	T	R	U	L	T	R	U	L	T	R	U	L	T	R
Movement	1U	1	2	3	4U	4	5	6		7	8	9		10	11	12
Priority																
Number of Lanes	0	1	1	0	0	0	1	1		0	0	0		1	0	1
Configuration		L	T				T	R						L		R
Volume (veh/h)		20	175				130	5						35		200
Percent Heavy Vehicles (%)		3												3		3
Proportion Time Blocked																
Percent Grade (%)																0
Right Turn Channelized							No									No
Median Type Storage		Undivided														

Critical and Follow-up Headways

Base Critical Headway (sec)		4.1												7.1		6.2
Critical Headway (sec)		4.13												6.43		6.23
Base Follow-Up Headway (sec)		2.2												3.5		3.3
Follow-Up Headway (sec)		2.23												3.53		3.33

Delay, Queue Length, and Level of Service

Flow Rate, v (veh/h)		25												44		253	
Capacity, c (veh/h)		1400												565		877	
v/c Ratio		0.02												0.08		0.29	
95% Queue Length, Q ₉₅ (veh)		0.1												0.3		1.2	
Control Delay (s/veh)		7.6												11.9		10.8	
Level of Service (LOS)		A												B		B	
Approach Delay (s/veh)		0.8												10.9			
Approach LOS														B			

HCS7 Two-Way Stop-Control Report

General Information		Site Information	
Analyst	Montgomery	Intersection	Powerline/Madison
Agency/Co.	JUB Engineers	Jurisdiction	City of Umatilla
Date Performed	11/18/2022	East/West Street	Madison Street
Analysis Year	2022	North/South Street	Powerline Road
Time Analyzed	PM Pk Hr season adj	Peak Hour Factor	0.88
Intersection Orientation	North-South	Analysis Time Period (hrs)	0.25
Project Description	Umatilla Transportation System Plan		

Lanes

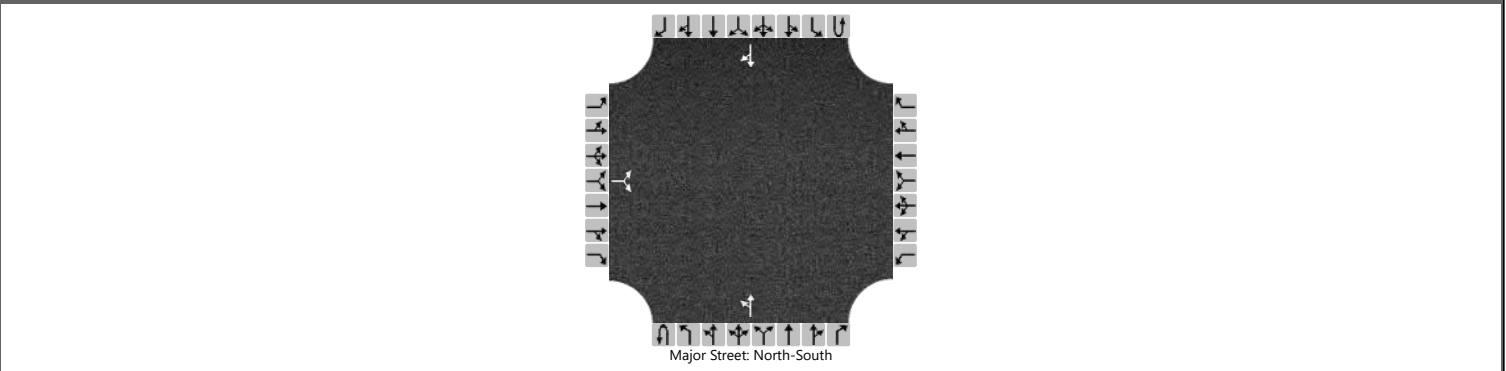

Vehicle Volumes and Adjustments

Approach	Eastbound				Westbound				Northbound				Southbound			
	U	L	T	R	U	L	T	R	U	L	T	R	U	L	T	R
Priority		10	11	12		7	8	9	1U	1	2	3	4U	4	5	6
Number of Lanes		0	1	0		0	0	0	0	0	1	0	0	0	1	0
Configuration			LR							LT						TR
Volume (veh/h)		15		5						10	160				180	10
Percent Heavy Vehicles (%)		3		3						3						
Proportion Time Blocked																
Percent Grade (%)		0														
Right Turn Channelized																
Median Type Storage		Undivided														

Critical and Follow-up Headways

Base Critical Headway (sec)		7.1		6.2						4.1						
Critical Headway (sec)		6.43		6.23						4.13						
Base Follow-Up Headway (sec)		3.5		3.3						2.2						
Follow-Up Headway (sec)		3.53		3.33						2.23						

Delay, Queue Length, and Level of Service

Flow Rate, v (veh/h)			23							11						
Capacity, c (veh/h)			633							1348						
v/c Ratio			0.04							0.01						
95% Queue Length, Q ₉₅ (veh)			0.1							0.0						
Control Delay (s/veh)			10.9							7.7						
Level of Service (LOS)			B							A						
Approach Delay (s/veh)		10.9								0.5						
Approach LOS		B														

Appendix E
Crash History 2016-2020

CRASH HISTORY 2016 - 2020, City of Umatilla

KABCO	CRASH_ID	CRASH_DATE	RTE_NM	MP_NO	ST_FULL_NAME	ISECT_ST_FULL_NM	CRASH_TYP_LONG_DESC	COLLIS_TYP_LONG_DESC	CRASH_SVRTY_LONG_DESC	CRASH_CAUSE_1_LONG_DESC	CRASH_CAUSE_2_LONG_DESC	CRASH_EVNT_1_LONG_DESC	T, UJ
C	1657097	6/28/16	I-82	0.5	MCNARY HY I-82	NB EF 6TH ST C2	From same direction - one stopped	Rear-End	Non-Fatal Injury	Failed to avoid vehicle ahead			4 - Possible Injury
C	1739061	12/30/17	I-82	0.79	MCNARY HY I-82	NB EF 6TH ST C2	From same direction - both going straight	Rear-End	Non-Fatal Injury	Failed to avoid vehicle ahead			4 - Possible Injury
	1901512	7/7/20	I-82	0.82	MCNARY HY I-82	SB EX 6TH ST C1	From same direction - both going straight	Rear-End	Property Damage Only	Improper change of traffic lanes	Did not yield right-of-way		5 - No Apparent Injury/PDO Crash (O)
	1884850	9/25/20	I-82	0.84	SB EX 6TH ST C1	MCNARY HY I-82	From same direction - one stopped	Rear-End	Non-Fatal Injury	Inattention	Failed to avoid vehicle ahead	Curve present at crash location	4 - Possible Injury Crash (C)
O	1815568	11/10/18	I-82	0.86	MCNARY HY I-82	SB EX 6TH ST C1	Fixed object	Fixed Object or Other Object	Property Damage Only	Drove left of center on two-way road; straddling		Median barrier (raised or metal)	5 - No Apparent Injury
O	1815464	11/6/18	I-82	0.93	MCNARY HY I-82	SB EX 6TH ST C1	From same direction - both going straight	Rear-End	Property Damage Only	Followed too closely			5 - No Apparent Injury
B	1838922	12/12/19	I-82	0.96	MCNARY HY I-82	SB EX 6TH ST C1	Fixed object	Fixed Object or Other Object	Non-Fatal Injury	Careless Driving (per PAR)	Driver drowsy/fatigued/sleepy	Cut slope or ditch embankment	3 - Suspected Minor Injury
O	1862556	10/21/19	I-82	0.96	SB EF 6TH ST C1	6TH ST	From same direction - both going straight	Rear-End	Property Damage Only	Too fast for conditions (not exceed posted speed)	Failed to avoid vehicle ahead		5 - No Apparent Injury
B	1656728	5/18/16	I-82	0.99	6TH ST	SB EX 6TH ST C1	Fixed Object	Fixed Object or Other Object	Non-Fatal Injury	Other improper driving		Curb (also narrow sidewalks on bridges)	3 - Suspected Minor Injury
C	1787520	9/10/18	I-82	0.99	6TH ST	SB EX 6TH ST C1	From same direction - one stopped	Rear-End	Non-Fatal Injury	Failed to avoid vehicle ahead			4 - Possible Injury
C	1844091	4/22/19	I-82	0.99	6TH ST	SB EX 6TH ST C1	From same direction - both going straight	Rear-End	Non-Fatal Injury	Failed to avoid vehicle ahead		Other (phantom) non-contact vehicle	4 - Possible Injury
O	1805290	7/1/18	I-82	0.99	6TH ST	SB EX 6TH ST C1	From same direction-all others, including parking	Turning Movement	Property Damage Only	Inattention	Failed to avoid vehicle ahead		5 - No Apparent Injury
	1901888	6/23/20	I-82	1.5	6TH ST	NB EX 6TH ST C2	From same direction - one turn, one straight	Rear-End	Property Damage Only	Failed to avoid vehicle ahead			5 - No Apparent Injury/PDO Crash (O)
B	1842413	9/12/19	US 395	184.08	6TH ST	SB EF 6TH ST C1	From opposite direction-one left turn,one straight	Turning Movement	Non-Fatal Injury	Made improper turn	Did not yield right-of-way		3 - Suspected Minor Injury
B	1842320	9/2/19	US 395	184.08	6TH ST	SB EF 6TH ST C1	From opposite direction-one left turn,one straight	Turning Movement	Non-Fatal Injury	Made improper turn	Did not yield right-of-way		3 - Suspected Minor Injury
C	1657669	8/12/16	US 395	184.08	6TH ST	SB EF 6TH ST C1	From same direction - one stopped	Rear-End	Non-Fatal Injury	Failed to avoid vehicle ahead			4 - Possible Injury
O	1751305	11/17/17	US 395	184.08	6TH ST	SB EF 6TH ST C1	From same direction - one stopped	Rear-End	Property Damage Only	Failed to avoid vehicle ahead			5 - No Apparent Injury
	1901631	7/14/20	US 395	184.08	6TH ST	SB EF 6TH ST C1	Entering at angle - all others	Turning Movement	Property Damage Only	Made improper turn	Did not yield right-of-way		5 - No Apparent Injury/PDO Crash (O)
	1902457	10/11/20	US 395	184.08	6TH ST	SB EF 6TH ST C1	From opposite direction-one left turn,one straight	Turning Movement	Property Damage Only	Inattention	Made improper turn		5 - No Apparent Injury/PDO Crash (O)
C	1678854	6/29/16	US 395	184.08	6TH ST	SB EX 6TH ST C1	From same direction - one stopped	Rear-End	Non-Fatal Injury	Followed too closely			4 - Possible Injury
O	1692115	4/15/16	US 395	184.08	6TH ST	SB EX 6TH ST C1	From same direction - one stopped	Rear-End	Property Damage Only	Failed to avoid vehicle ahead	Careless Driving (per PAR)		5 - No Apparent Injury
O	1750277	8/9/17	US 395	184.08	6TH ST	SB EX 6TH ST C1	From same direction-all others, including parking	Turning movement	Property Damage Only	Failed to avoid vehicle ahead			5 - No Apparent Injury
O	1857200	1/2/19	US 395	184.08	6TH ST	SB EX 6TH ST C1	From same direction-all others, including parking	Turning Movement	Property Damage Only	Failed to avoid vehicle ahead			5 - No Apparent Injury

KABCO	CRASH_ID	CRASH_DATE	RTE_NM	MP_NO	ST_FULL_NAME	ISECT_ST_FULL_NM	CRASH_TYP_LONG_DESC	COLLIS_TYP_LONG_DESC	CRASH_SVRTY_LONG_DESC	CRASH_CAUSE_1_LONG_DESC	CRASH_CAUSE_2_LONG_DESC	CRASH_EVNT_1_LONG_DESC	T, UJ
O	1750677	10/4/17	US 395	184.08	6TH ST	SB EX 6TH ST C1	From same direction - one turn, one straight	Rear-End	Property Damage Only	Followed too closely			5 - No Apparent Injury
O	1863007	11/9/19	US 395	184.08	6TH ST	SB EX 6TH ST C1	From same direction - one stopped	Rear-End	Property Damage Only	Failed to avoid vehicle ahead			5 - No Apparent Injury
O	1692075	4/19/16	US 395	184.08	SB EX 6TH ST C1	6TH ST	From same direction-all others, including parking	Turning movement	Property Damage Only	Followed too closely			5 - No Apparent Injury
C	1655970	2/18/16	US 395	184.09	6TH ST	SB EX 6TH ST C1	From same direction - one stopped	Rear-End	Non-Fatal Injury	Careless Driving (per PAR)	Failed to avoid vehicle ahead	Vehicle forced by impact into another vehicle, pedalcyclist or pedestrian	4 - Possible Injury
B	1719336	7/10/17	US 395	184.11	6TH ST	SB EX 6TH ST C1	From same direction - one stopped	Rear-End	Non-Fatal Injury	Careless Driving (per PAR)	Inattention	Vehicle forced by impact into another vehicle, pedalcyclist or pedestrian	3 - Suspected Minor Injury
	1884252	7/6/20	US 395	184.15	6TH ST	NB EF 6TH ST C2	From same direction - one stopped	Rear-End	Non-Fatal Injury	Inattention	Failed to avoid vehicle ahead	Vehicle forced by impact into another vehicle, pedalcyclist or pedestrian	3 - Suspected Minor Injury Crash (B)
B	1656734	5/18/16	US 395	184.17	6TH ST	NB EF 6TH ST C2	Entering at angle - all others	Angle	Non-Fatal Injury	Did not yield right-of-way			3 - Suspected Minor Injury
C	1841523	11/6/19	US 395	184.17	6TH ST	NB EF 6TH ST C2	Fixed object	Fixed Object or Other Object	Non-Fatal Injury	Other improper driving		Cut slope or ditch embankment	4 - Possible Injury
O	1692128	4/21/16	US 395	184.17	6TH ST	NB EF 6TH ST C2	Entering at angle - all others	Turning movement	Property Damage Only	Did not yield right-of-way			5 - No Apparent Injury
O	1803908	3/9/18	US 395	184.17	6TH ST	NB EF 6TH ST C2	Entering at angle - all others	Angle	Property Damage Only	Careless Driving (per PAR)	Did not yield right-of-way		5 - No Apparent Injury
O	1805624	8/5/18	US 395	184.17	6TH ST	NB EF 6TH ST C2	Entering at angle - all others	Turning Movement	Property Damage Only	Did not yield right-of-way			5 - No Apparent Injury
O	1749804	6/21/17	US 395	184.17	6TH ST	NB EF 6TH ST C2	Entering at angle - all others	Angle	Property Damage Only	Did not yield right-of-way			5 - No Apparent Injury
O	1861698	6/27/19	US 395	184.17	6TH ST	NB EF 6TH ST C2	Entering at angle - all others	Angle	Property Damage Only	Made improper turn	Did not yield right-of-way		5 - No Apparent Injury
O	1804222	4/5/18	US 395	184.17	6TH ST	NB EF 6TH ST C2	Fixed object	Fixed Object or Other Object	Property Damage Only	Too fast for conditions (not exceed posted speed)		Fence	5 - No Apparent Injury
	1884777	9/16/20	US 395	184.17	6TH ST	NB EF 6TH ST C2	Entering at angle - all others	Angle	Non-Fatal Injury	Did not yield right-of-way	Disregarded traffic signal	Pole – power or telephone	4 - Possible Injury Crash (C)
	1878439	1/10/20	US 395	184.17	6TH ST	NB EF 6TH ST C2	Entering at angle - all others	Angle	Non-Fatal Injury	Careless Driving (per PAR)	Did not yield right-of-way		4 - Possible Injury Crash (C)
O	1750803	3/24/17	US 395	184.17	6TH ST	NB EX 6TH ST C2	Entering at angle - all others	Turning movement	Property Damage Only	Did not yield right-of-way			5 - No Apparent Injury
O	1750486	9/6/17	US 395	184.17	6TH ST	NB EX 6TH ST C2	Entering at angle - all others	Turning movement	Property Damage Only	Did not yield right-of-way			5 - No Apparent Injury
	1902434	10/27/20	US 395	184.17	6TH ST	NB EX 6TH ST C2	From same direction - one stopped	Rear-End	Property Damage Only	Followed too closely			5 - No Apparent Injury/PDO Crash (O)
O	1805381	7/13/18	US 395	184.18	6TH ST	NB EF 6TH ST C2	From opposite direction - one stopped	Backing	Property Damage Only	Improper change of traffic lanes			5 - No Apparent Injury
O	1693480	11/10/16	US 395	184.18	NB EF 6TH ST C2	6TH ST	From same direction - both going straight	Sideswipe - Overtaking	Property Damage Only	Did not yield right-of-way		Vertical grade / hill present at crash location	5 - No Apparent Injury
C	1775226	2/21/18	US 395	184.28	NB EF 6TH ST C2	6TH ST	From same direction - one stopped	Rear-End	Non-Fatal Injury	Failed to avoid vehicle ahead			4 - Possible Injury
O	1860768	5/30/19	US 395	184.3	6TH ST	POWER CITY RD	From same direction - both going straight	Sideswipe - Overtaking	Property Damage Only	Did not yield right-of-way			5 - No Apparent Injury
O	1861721	6/6/19	US 395	184.31	6TH ST	POWER CITY RD	From same direction - both going straight	Rear-End	Property Damage Only	Followed too closely			5 - No Apparent Injury

KABCO	CRASH_ID	CRASH_DATE	RTE_NM	MP_NO	ST_FULL_NAME	ISECT_ST_FULL_NM	CRASH_TYP_LONG_DESC	COLLIS_TYP_LONG_DESC	CRASH_SVRTY_LONG_DESC	CRASH_CAUSE_1_LONG_DESC	CRASH_CAUSE_2_LONG_DESC	CRASH_EVNT_1_LONG_DESC	T, UJ
O	1859885	2/25/19	US 395	184.34	6TH ST	SCAPLEHORN RD	Other non-collision	Non-collision	Property Damage Only	Too fast for conditions (not exceed posted speed)		Sliding or swerving due to wet, icy, slippery or loose surface (not gravel)	5 - No Apparent Injury
	1902393	10/13/20	US 395	184.36	NB EF 6TH ST C2	MCNARY HY I-82	From same direction - both going straight	Rear-End	Property Damage Only	Inattention	Followed too closely		5 - No Apparent Injury/PDO Crash (O)
	1900165	4/7/20	US 395	184.37	SCAPLEHORN RD	6TH ST	Animal	Miscellaneous	Property Damage Only	Other (not improper driving)		Deer or elk, wapiti	5 - No Apparent Injury/PDO Crash (O)
O	1862960	11/9/19	US 395	184.39	6TH ST	SCAPLEHORN RD	Animal	Miscellaneous	Property Damage Only	Other (not improper driving)		Deer or elk, wapiti	5 - No Apparent Injury
O	1748465	1/9/17	US 395	184.4	6TH ST	SCAPLEHORN RD	Fixed Object	Fixed Object or Other Object	Property Damage Only	Too fast for conditions (not exceed posted speed)		Guard rail (not metal median barrier)	5 - No Apparent Injury
C	1719596	1/9/17	US 395	184.44	6TH ST	SCAPLEHORN RD	From opposite direction - both going straight	Sideswipe - Meeting	Non-Fatal Injury	Drove left of center on two-way road; straddling		Sliding or swerving due to wet, icy, slippery or loose surface (not gravel)	4 - Possible Injury
C	1661681	12/19/16	US 395	184.5	6TH ST	POWER CITY RD	Fixed Object	Fixed Object or Other Object	Non-Fatal Injury	Too fast for conditions (not exceed posted speed)		Cut slope or ditch embankment	4 - Possible Injury
O	1815699	11/23/18	US 395	184.79	COLUMBIA RIVER HY	LIND ST	Fixed object	Fixed Object or Other Object	Property Damage Only	Tire Failure		Pole – type unknown	5 - No Apparent Injury
O	1862314	10/6/19	US 730	182.65	6TH ST	A ST	Fixed object	Fixed Object or Other Object	Property Damage Only	Physical illness		Bridge railing or parapet (on bridge or approach)	5 - No Apparent Injury
A	1656894	6/5/16	US 730	182.71	B ST	6TH ST	From same direction - one stopped	Rear-End	Non-Fatal Injury	Followed too closely	Inattention		2 - Suspected Serious Injury
	1884903	9/29/20	US 730	182.72	6TH ST	B ST	From same direction - one stopped	Rear-End	Non-Fatal Injury	Inattention	Failed to avoid vehicle ahead		4 - Possible Injury Crash (C)
O	1749878	6/30/17	US 730	182.8	6TH ST	D ST	From same direction - one stopped	Rear-End	Property Damage Only	Inattention			5 - No Apparent Injury
O	1691937	5/24/16	US 730	182.82	D ST	6TH ST	From same direction - one stopped	Rear-End	Property Damage Only	Followed too closely			5 - No Apparent Injury
O	1803545	2/9/18	US 730	182.83	6TH ST	D ST	Parked motor vehicle	Rear-End	Property Damage Only	Inattention	Drove left of center on two-way road; straddling		5 - No Apparent Injury
C	1782002	6/30/18	US 730	182.87	E ST	6TH ST	From same direction - both going straight	Rear-End	Non-Fatal Injury	Careless Driving (per PAR)	Driver drowsy/fatigued/sleepy		4 - Possible Injury
O	1861143	5/2/19	US 730	182.92	F ST	6TH ST	Other object	Fixed Object or Other Object	Property Damage Only	Made improper turn		Non-fixed object, other or unknown type	5 - No Apparent Injury
C	1790201	10/25/18	US 730	182.96	G ST	6TH ST	From same direction - one stopped	Rear-End	Non-Fatal Injury	Failed to avoid vehicle ahead			4 - Possible Injury
O	1862331	10/8/19	US 730	183.03	H ST	6TH ST	Entering at angle - all others	Turning Movement	Property Damage Only	Made improper turn	Did not yield right-of-way		5 - No Apparent Injury
	1880526	3/4/20	US 730	183.03	H ST	6TH ST	From opposite direction-one left turn,one straight	Turning Movement	Non-Fatal Injury	Made improper turn	Did not yield right-of-way		4 - Possible Injury Crash (C)
	1902405	10/14/20	US 730	183.03	H ST	6TH ST	From same direction - both going straight	Rear-End	Property Damage Only	Failed to avoid vehicle ahead	View obscured		5 - No Apparent Injury/PDO Crash (O)
O	1860385	3/14/19	US 730	183.06	6TH ST	I ST	Overtaken	Miscellaneous	Property Damage Only	Other (not improper driving)		Other (phantom) non-contact vehicle	5 - No Apparent Injury
	1902026	3/6/20	US 730	183.09	6TH ST	I ST	From same direction - both going straight	Sideswipe - Overtaking	Property Damage Only	Improper change of traffic lanes	Did not yield right-of-way		5 - No Apparent Injury/PDO Crash (O)
O	1750025	7/20/17	US 730	183.12	6TH ST	J ST	From same direction - one stopped	Rear-End	Property Damage Only	Followed too closely			5 - No Apparent Injury
O	1691968	5/29/16	US 730	183.13	J ST	6TH ST	Entering at angle - all others	Angle	Property Damage Only	Did not yield right-of-way			5 - No Apparent Injury

KABCO	CRASH_ID	CRASH_DATE	RTE_NM	MP_NO	ST_FULL_NAME	ISECT_ST_FULL_NM	CRASH_TYP_LONG_DESC	COLLIS_TYP_LONG_DESC	CRASH_SVRTY_LONG_DESC	CRASH_CAUSE_1_LONG_DESC	CRASH_CAUSE_2_LONG_DESC	CRASH_EVNT_1_LONG_DESC	T, UJ
C	1861933	2/16/19	US 730	183.15	6TH ST	J ST	From same direction-all others, including parking	Parking Maneuver	Non-Fatal Injury	Did not yield right-of-way	Careless Driving (per PAR)		4 - Possible Injury
C	1841246	6/16/19	US 730	183.19	K ST	6TH ST	From same direction - one stopped	Rear-End	Non-Fatal Injury	Careless Driving (per PAR)	Driver drowsy/fatigued/sleepy	Pedestrian indirectly involved (not struck)	4 - Possible Injury
C	1719173	3/12/17	US 730	183.25	L ST	6TH ST	Pedestrian	Pedestrian	Non-Fatal Injury	Did not yield right-of-way			4 - Possible Injury
C	1783879	7/26/18	US 730	183.26	6TH ST	L ST	From same direction - both going straight	Rear-End	Non-Fatal Injury	Failed to avoid vehicle ahead		Building or other structure	4 - Possible Injury
B	1678830	10/2/16	US 730	183.31	6TH ST	SWITZLER AVE	Fixed Object	Fixed Object or Other Object	Non-Fatal Injury	Driver drowsy/fatigued/sleepy		Rock(s), boulder (not gravel; not rock slide)	3 - Suspected Minor Injury
	1900438	2/28/20	US 730	183.34	6TH ST	SWITZLER AVE	From same direction - one stopped	Rear-End	Property Damage Only	Inattention	Followed too closely	Pedestrian indirectly involved (not struck)	5 - No Apparent Injury/PDO Crash (O)
C	1777824	3/7/18	US 730	183.34	SWITZLER AVE	6TH ST	From same direction - one stopped	Rear-End	Non-Fatal Injury	Failed to avoid vehicle ahead			4 - Possible Injury
O	1692552	7/16/16	US 730	183.35	6TH ST	SWITZLER AVE	From same direction - one stopped	Rear-End	Property Damage Only	Inattention			5 - No Apparent Injury
O	1862958	11/1/19	US 730	183.36	6TH ST	SWITZLER AVE	From same direction - one stopped	Sideswipe - Overtaking	Property Damage Only	Inattention	Improper overtaking		5 - No Apparent Injury
C	1775198	1/30/18	US 730	183.43	YERXA AVE	6TH ST	Entering at angle - all others	Turning Movement	Non-Fatal Injury	Did not yield right-of-way	View obscured	Vehicle obscured view	4 - Possible Injury
C	1775176	1/12/18	US 730	183.43	YERXA AVE	6TH ST	From same direction - both going straight	Rear-End	Non-Fatal Injury	Followed too closely			4 - Possible Injury
C	1655711	1/13/16	US 730	183.43	YERXA AVE	6TH ST	Entering at angle - all others	Angle	Non-Fatal Injury	Did not yield right-of-way			4 - Possible Injury
O	1804187	3/28/18	US 730	183.44	6TH ST	YERXA AVE	Entering at angle - all others	Turning Movement	Property Damage Only	Did not yield right-of-way			5 - No Apparent Injury
O	1692174	4/8/16	US 730	183.45	6TH ST	YERXA AVE	From same direction - one stopped	Rear-End	Property Damage Only	Failed to avoid vehicle ahead			5 - No Apparent Injury
O	1749287	3/6/17	US 730	183.51	6TH ST	SLOAN AVE	Fixed Object	Fixed Object or Other Object	Property Damage Only	Drove left of center on two-way road; straddling		Median barrier (raised or metal)	5 - No Apparent Injury
C	1657449	7/15/16	US 730	183.53	6TH ST	SLOAN AVE	From same direction - one stopped	Rear-End	Non-Fatal Injury	Failed to avoid vehicle ahead			4 - Possible Injury
	1901030	8/27/20	US 730	183.54	6TH ST	SLOAN AVE	From opposite direction-one left turn,one straight	Turning Movement	Property Damage Only	Made improper turn	Did not yield right-of-way		5 - No Apparent Injury/PDO Crash (O)
C	1657765	8/29/16	US 730	183.55	JANE AVE	6TH ST	From same direction - one turn, one straight	Rear-End	Non-Fatal Injury	Followed too closely			4 - Possible Injury
B	1655880	1/29/16	US 730	183.66	RIVER RD	6TH ST	Pedestrian	Pedestrian	Non-Fatal Injury	Did not yield right-of-way	Non-motorist not visible; non-reflective clothing		3 - Suspected Minor Injury
C	1861041	6/6/19	US 730	183.66	RIVER RD	6TH ST	Entering at angle - all others	Turning Movement	Non-Fatal Injury	Made improper turn	Did not yield right-of-way	Guard rail (not metal median barrier)	4 - Possible Injury
O	1803913	2/19/18	US 730	183.66	RIVER RD	6TH ST	From opposite direction-one left turn,one straight	Turning Movement	Property Damage Only	Did not yield right-of-way			5 - No Apparent Injury
O	1858959	8/16/19	US 730	183.66	RIVER RD	6TH ST	Entering at angle - all others	Turning Movement	Property Damage Only	Did not yield right-of-way			5 - No Apparent Injury
O	1692790	8/10/16	US 730	183.88	EISELE ST	6TH ST	Entering at angle - all others	Turning movement	Property Damage Only	Did not yield right-of-way			5 - No Apparent Injury
O	1858187	2/4/19	US 730	183.88	EISELE ST	6TH ST	From same direction - one stopped	Rear-End	Property Damage Only	Too fast for conditions (not exceed posted speed)	Followed too closely	Sliding or swerving due to wet, icy, slippery or loose surface (not gravel)	5 - No Apparent Injury

KABCO	CRASH_ID	CRASH_DATE	RTE_NM	MP_NO	ST_FULL_NAME	ISECT_ST_FULL_NM	CRASH_TYP_LONG_DESC	COLLIS_TYP_LONG_DESC	CRASH_SVRTY_LONG_DESC	CRASH_CAUSE_1_LONG_DESC	CRASH_CAUSE_2_LONG_DESC	CRASH_EVNT_1_LONG_DESC	T, UJ
O	1867938	12/1/19	US 730	183.88	EISELE ST	6TH ST	Fixed object	Fixed Object or Other Object	Property Damage Only	Too fast for conditions (not exceed posted speed)	Made improper turn	Curb (also narrow sidewalks on bridges)	5 - No Apparent Injury
	1883992	8/12/20	US 730	183.88	EISELE ST	6TH ST	Entering at angle - all others	Turning Movement	Non-Fatal Injury	Careless Driving (per PAR)	Inattention		4 - Possible Injury Crash (C)
O	1803921	3/11/18	US 730	183.91	6TH ST	EISELE ST	From same direction - both going straight	Sideswipe - Overtaking	Property Damage Only	Did not yield right-of-way			5 - No Apparent Injury
O	1748485	1/13/17	US 730	183.93	6TH ST	EISELE ST	From same direction - both going straight	Rear-End	Property Damage Only	Phantom / Non-contact Vehicle		Other (phantom) non-contact vehicle	5 - No Apparent Injury
B	1657807	9/9/16	US 730	183.94	6TH ST	EISELE ST	From opposite direction-one left turn,one straight	Turning movement	Non-Fatal Injury	Did not yield right-of-way	Too fast for conditions (not exceed posted speed)	Vehicle forced by impact into another vehicle, pedalcyclist or pedestrian	3 - Suspected Minor Injury
C	1719199	3/23/17	US 730	183.99	6TH ST	BROWNELL BLVD	From opposite direction-one left turn,one straight	Turning movement	Non-Fatal Injury	Did not yield right-of-way			4 - Possible Injury
O	1691419	9/22/16	US 730	183.99	6TH ST	BROWNELL BLVD	Fixed Object	Fixed Object or Other Object	Property Damage Only	Inattention		Fixed object, unknown type.	5 - No Apparent Injury
O	1691959	5/27/16	US 730	183.99	6TH ST	BROWNELL BLVD	Entering at angle - all others	Turning movement	Property Damage Only	Did not yield right-of-way			5 - No Apparent Injury
B	1656812	5/31/16	US 730	183.99	BROWNELL BLVD	6TH ST	From opposite direction-one left turn,one straight	Turning movement	Non-Fatal Injury	Reckless Driving (per PAR)			3 - Suspected Minor Injury
O	1692531	7/11/16	US 730	184	6TH ST	BROWNELL BLVD	From same direction - one stopped	Rear-End	Property Damage Only	Failed to avoid vehicle ahead		Vehicle forced by impact into another vehicle, pedalcyclist or pedestrian	5 - No Apparent Injury
	1902637	9/30/20	US 730	184	6TH ST	BROWNELL BLVD	From same direction - both going straight	Sideswipe - Overtaking	Property Damage Only	Inattention	Improper change of traffic lanes		5 - No Apparent Injury/PDO Crash (O)
O	1751471	12/17/17	US 730	184.01	6TH ST	BROWNELL BLVD	From same direction - both going straight	Sideswipe - Overtaking	Property Damage Only	Improper change of traffic lanes			5 - No Apparent Injury
C	1795886	11/1/18	US 730	184.02	6TH ST	BROWNELL BLVD	From same direction - one stopped	Rear-End	Non-Fatal Injury	Inattention		Cell phone (on PAR or driver in use)	4 - Possible Injury
A	1722347	10/3/17	US 730	184.03	BROWNELL BLVD	6TH ST	Entering at angle - all others	Turning movement	Non-Fatal Injury	Disregarded traffic signal			2 - Suspected Serious Injury
B	1837722	4/28/19	US 730	184.03	BROWNELL BLVD	6TH ST	From same direction - one stopped	Rear-End	Non-Fatal Injury	Failed to avoid vehicle ahead			3 - Suspected Minor Injury
C	1661734	12/21/16	US 730	184.03	BROWNELL BLVD	6TH ST	From same direction - one stopped	Rear-End	Non-Fatal Injury	Followed too closely			4 - Possible Injury
O	1805079	6/24/18	US 730	184.03	BROWNELL BLVD	6TH ST	Entering at angle - all others	Angle	Property Damage Only	Inattention	Disregarded traffic signal		5 - No Apparent Injury
O	1815938	10/31/18	US 730	184.03	BROWNELL BLVD	6TH ST	From opposite direction-one left turn,one straight	Turning Movement	Property Damage Only	Disregarded traffic signal			5 - No Apparent Injury
O	1862147	9/27/19	US 730	184.03	BROWNELL BLVD	6TH ST	From opposite direction-all others incl. parking	Turning Movement	Property Damage Only	Did not yield right-of-way		Wind Gust	5 - No Apparent Injury
	1902361	10/9/20	US 730	184.03	BROWNELL BLVD	6TH ST	From same direction - one stopped	Rear-End	Property Damage Only	Failed to avoid vehicle ahead			5 - No Apparent Injury/PDO Crash (O)
	1884770	9/14/20	US 730	184.03	BROWNELL BLVD	6TH ST	From same direction - one stopped	Rear-End	Non-Fatal Injury	Failed to avoid vehicle ahead			4 - Possible Injury Crash (C)
	1893320	7/26/20	US 730	184.03	BROWNELL BLVD	6TH ST	Pedalcyclist	Angle	Non-Fatal Injury			Non-motorist struck vehicle	3 - Suspected Minor Injury Crash (B)
O	1805735	8/14/18	US 730	184.05	6TH ST	BROWNELL BLVD	From same direction - one stopped	Rear-End	Property Damage Only	Failed to avoid vehicle ahead			5 - No Apparent Injury
O	1861930	7/10/19	US 730	184.06	6TH ST	SB EF 6TH ST C1	From same direction - both going straight	Rear-End	Property Damage Only	Failed to avoid vehicle ahead			5 - No Apparent Injury

KABCO	CRASH_ID	CRASH_DATE	RTE_NM	MP_NO	ST_FULL_NAME	ISECT_ST_FULL_NM	CRASH_TYP_LONG_DESC	COLLIS_TYP_LONG_DESC	CRASH_SVRTY_LONG_DESC	CRASH_CAUSE_1_LONG_DESC	CRASH_CAUSE_2_LONG_DESC	CRASH_EVNT_1_LONG_DESC	T, UJ
A	1656694	5/8/16	US 730	184.83	EB EXTO HY54 C1	COLUMBIA RIVER HY	Fixed Object	Fixed Object or Other Object	Non-Fatal Injury	Other improper driving		Rock(s), boulder (not gravel; not rock slide)	2 - Suspected Serious Injury
C	1803272	1/19/18	US 730	184.85	COLUMBIA RIVER HY	UMATILLA-STANFLD HY	From same direction - one stopped	Rear-End	Non-Fatal Injury	Driver drowsy/fatigued/sleepy	Physical illness	Vehicle forced by impact into another vehicle, pedalcyclist or pedestrian	4 - Possible Injury
O	1749012	2/8/17	US 730	184.85	COLUMBIA RIVER HY	UMATILLA-STANFLD HY	From same direction - one stopped	Rear-End	Property Damage Only	Too fast for conditions (not exceed posted speed)		Sliding or swerving due to wet, icy, slippery or loose surface (not gravel)	5 - No Apparent Injury
B	1655679	1/7/16	US 730	184.87	COLUMBIA RIVER HY	UMATILLA-STANFLD HY	Entering at angle - all others	Turning movement	Non-Fatal Injury	Inattention	Disregarded traffic signal		3 - Suspected Minor Injury
B	1781925	6/5/18	US 730	184.87	COLUMBIA RIVER HY	UMATILLA-STANFLD HY	Entering at angle - all others	Turning Movement	Non-Fatal Injury	Disregarded traffic signal			3 - Suspected Minor Injury
C	1775161	1/8/18	US 730	184.87	COLUMBIA RIVER HY	UMATILLA-STANFLD HY	From opposite direction-one left turn,one straight	Turning Movement	Non-Fatal Injury	Disregarded traffic signal			4 - Possible Injury
C	1837727	9/24/19	US 730	184.87	COLUMBIA RIVER HY	UMATILLA-STANFLD HY	From opposite direction-one left turn,one straight	Turning Movement	Non-Fatal Injury	Disregarded traffic signal	Did not yield right-of-way		4 - Possible Injury
O	1751316	11/20/17	US 730	184.87	COLUMBIA RIVER HY	UMATILLA-STANFLD HY	From opposite direction-one left turn,one straight	Turning movement	Property Damage Only	Inattention	Disregarded traffic signal		5 - No Apparent Injury
	1888706	9/26/20	US 730	184.89	COLUMBIA RIVER HY	UMATILLA-STANFLD HY	From same direction - one stopped	Rear-End	Non-Fatal Injury	Reckless Driving (per PAR)	Followed too closely		4 - Possible Injury Crash (C)
B	1839658	2/11/19	US 730	184.96	COLUMBIA RIVER HY	LIND ST	From opposite direction - both going straight	Sideswipe - Meeting	Non-Fatal Injury	Other (not improper driving)		Sliding or swerving due to wet, icy, slippery or loose surface (not gravel)	3 - Suspected Minor Injury
C	1657717	8/21/16	US 730	185	6TH ST	WILDWOOD LN	From same direction - both going straight	Sideswipe - Overtaking	Non-Fatal Injury	Improper change of traffic lanes			4 - Possible Injury
B	1837774	8/3/19	US 730	185.11	COLUMBIA RIVER HY	COLUMBIA BLVD	Entering at angle - all others	Turning Movement	Non-Fatal Injury	Careless Driving (per PAR)	Did not yield right-of-way		3 - Suspected Minor Injury
B	1787477	9/5/18	US 730	185.11	COLUMBIA RIVER HY	COLUMBIA BLVD	Entering at angle - all others	Turning Movement	Non-Fatal Injury	Did not yield right-of-way	Inattention		3 - Suspected Minor Injury
O	1691513	6/2/16	US 730	185.11	COLUMBIA RIVER HY	COLUMBIA BLVD	Fixed Object	Fixed Object or Other Object	Property Damage Only	Other improper driving		Leading edge of guardrail	5 - No Apparent Injury
O	1815326	12/18/18	US 730	185.12	COLUMBIA RIVER HY	COLUMBIA BLVD	Entering at angle - all others	Turning Movement	Property Damage Only	Did not yield right-of-way			5 - No Apparent Injury
O	1815644	11/20/18	US 730	185.33	COLUMBIA RIVER HY	WILLAMETTE AVE	From same direction - one stopped	Rear-End	Property Damage Only	Failed to avoid vehicle ahead			5 - No Apparent Injury
C	1718770	3/9/17	US 730	185.36	COLUMBIA RIVER HY	COLUMBIA BLVD	From same direction - both going straight	Rear-End	Non-Fatal Injury	Failed to avoid vehicle ahead			4 - Possible Injury
O	1693229	11/16/16	US 730	185.37	COLUMBIA RIVER HY	COLUMBIA BLVD	From same direction - both going straight	Sideswipe - Overtaking	Property Damage Only	Improper change of traffic lanes			5 - No Apparent Injury
	1878447	1/13/20	US 730	185.5	COLUMBIA RIVER HY	WILLAMETTE AVE	From opposite direction - both going straight	Sideswipe - Meeting	Non-Fatal Injury	Drove left of center on two-way road; straddling	Did not yield right-of-way	Sliding or swerving due to wet, icy, slippery or loose surface (not gravel)	3 - Suspected Minor Injury Crash (B)
B	1718286	1/1/17	US 730	185.65	COLUMBIA RIVER HY	WILLAMETTE AVE	Fixed Object	Fixed Object or Other Object	Non-Fatal Injury	Too fast for conditions (not exceed posted speed)		Fence	3 - Suspected Minor Injury
C	1838627	8/26/19	US 730	185.71	COLUMBIA RIVER HY	WILLAMETTE AVE	From same direction - one stopped	Rear-End	Non-Fatal Injury	Followed too closely			4 - Possible Injury
C	1722305	9/27/17	US 730	185.71	COLUMBIA RIVER HY	WILLAMETTE AVE	From opposite direction-one left turn,one straight	Turning movement	Non-Fatal Injury	Did not yield right-of-way			4 - Possible Injury
O	1815600	11/16/18	US 730	185.71	COLUMBIA RIVER HY	WILLAMETTE AVE	Entering at angle - all others	Turning Movement	Property Damage Only	Did not yield right-of-way			5 - No Apparent Injury
B	1657175	7/6/16	US 730	185.72	COLUMBIA RIVER HY	WILLAMETTE AVE	Overtaken	Non-collision	Non-Fatal Injury	Phantom / Non-contact Vehicle		Occupant fell, jumped or was ejected from moving vehicle	3 - Suspected Minor Injury

KABCO	CRASH_ID	CRASH_DATE	RTE_NM	MP_NO	ST_FULL_NAME	ISECT_ST_FULL_NM	CRASH_TYP_LONG_DESC	COLLIS_TYP_LONG_DESC	CRASH_SVRTY_LONG_DESC	CRASH_CAUSE_1_LONG_DESC	CRASH_CAUSE_2_LONG_DESC	CRASH_EVNT_1_LONG_DESC	T, UJ
C	1658748	11/4/16	US 730	185.72	COLUMBIA RIVER HY	WILLAMETTE AVE	From opposite direction-one left turn,one straight	Turning movement	Non-Fatal Injury	Did not yield right-of-way			4 - Possible Injury
O	1749791	6/17/17	US 730	185.72	COLUMBIA RIVER HY	WILLAMETTE AVE	From opposite direction-one left turn,one straight	Turning movement	Property Damage Only	Did not yield right-of-way			5 - No Apparent Injury
	1902159	3/26/20	US 730	185.95	COLUMBIA RIVER HY	WILLAMETTE AVE	Other object	Fixed Object or Other Object	Property Damage Only	Other (not improper driving)		Non-fixed object, other or unknown type	5 - No Apparent Injury/PDO Crash (O)
O	1750775	10/23/17	US 730	186.21	COLUMBIA RIVER HY	BUD DRAPER RD	Animal	Miscellaneous	Property Damage Only	Other (not improper driving)		Stock: cow, calf, bull, steer, sheep, etc.	5 - No Apparent Injury
O	1673151	1/7/16	US 730	186.33	COLUMBIA RIVER HY	BUD DRAPER RD	Other object	Fixed Object or Other Object	Property Damage Only	Other (not improper driving)		Foreign obstruction/debris in road (not gravel)	5 - No Apparent Injury
B	1718775	4/1/17	US 730	186.36	BUD DRAPER RD	COLUMBIA RIVER HY	Fixed Object	Fixed Object or Other Object	Non-Fatal Injury	Passed stop sign or red flasher	Too fast for conditions (not exceed posted speed)	Fence	3 - Suspected Minor Injury
O	1691324	6/12/16	US 730	186.61	COLUMBIA RIVER HY	BUD DRAPER RD	Animal	Miscellaneous	Property Damage Only	Other (not improper driving)		Deer or elk, wapiti	5 - No Apparent Injury
C	1789502	10/6/18		0.04	COLUMBIA RIVER HY	UMATILLA-STANFLD HY	From same direction - one stopped	Rear-End	Non-Fatal Injury	Failed to avoid vehicle ahead			4 - Possible Injury
C	1722371	10/9/17		0.04	COLUMBIA RIVER HY	UMATILLA-STANFLD HY	From same direction - one stopped	Rear-End	Non-Fatal Injury	Followed too closely			4 - Possible Injury
O	1863336	11/11/19			3RD ST	QUINCY AVE	Fixed object	Fixed Object or Other Object	Property Damage Only	Driver drowsy/fatigued/sleepy		Cut slope or ditch embankment	5 - No Apparent Injury
O	1692677	7/24/16			5TH ST	H ST	Entering at angle - all others	Backing	Property Damage Only	Other improper driving			5 - No Apparent Injury
O	1749567	5/10/17			7TH ST	J ST	Parked motor vehicle	Rear-End	Property Damage Only	Driver drowsy/fatigued/sleepy	Inattention	Vehicle forced by impact into another vehicle, pedalcyclist or pedestrian	5 - No Apparent Injury
O	1805944	9/12/18			7TH ST	L ST	From same direction - one stopped	Rear-End	Property Damage Only	Failed to avoid vehicle ahead			5 - No Apparent Injury
O	1805111	6/24/18			8TH ST	SLOAN AVE	Parked motor vehicle	Backing	Property Damage Only	Other improper driving			5 - No Apparent Injury
B	1840795	7/4/19			BEACH ACCESS RD	COLUMBIA RIVER HY	From same direction - one stopped	Rear-End	Non-Fatal Injury	Followed too closely	Vehicle improperly parked		3 - Suspected Minor Injury
O	1818275	11/28/18			BEACH ACCESS RD	COLUMBIA RIVER HY	From opposite direction - both going straight	Miscellaneous	Property Damage Only	Other improper driving		Detached trailing object struck other vehicle, non-motorist, or object	5 - No Apparent Injury
O	1803933	3/8/18			BEACH ACCESS RD	COLUMBIA RIVER HY	From same direction - one stopped	Rear-End	Property Damage Only	Failed to avoid vehicle ahead			5 - No Apparent Injury
O	1804305	4/12/18			BLUE BIRD DR	PINE TREE LN	Entering at angle - all others	Turning Movement	Property Damage Only	Did not yield right-of-way			5 - No Apparent Injury
C	1785862	6/26/18			BOBWHITE AVE	HAWK CIR	Parked motor vehicle	Head-On	Non-Fatal Injury	Defective steering mechanism	Drove left of center on two-way road; straddling		4 - Possible Injury
	1906876	11/4/20			BROWNELL BLVD	3RD ST	Fixed object	Fixed Object or Other Object	Property Damage Only	Reckless Driving (per PAR)		Cut slope or ditch embankment	5 - No Apparent Injury/PDO Crash (O)
O	1863194	11/25/19			CAROLINA RD	RAYMOND ST	Parked motor vehicle	Rear-End	Property Damage Only	Other improper driving			5 - No Apparent Injury
O	1863350	4/28/19			CAROLINA RD	RAYMOND ST	Parked motor vehicle	Backing	Property Damage Only	Careless Driving (per PAR)	Inattention	Vertical grade / hill present at crash location	5 - No Apparent Injury
O	1714336	4/3/16			CLINE AVE	3RD ST	Other non-collision	Non-collision	Property Damage Only	Other improper driving		Vehicle immersed in body of water	5 - No Apparent Injury
O	1861783	7/8/19			COLUMBIA BLVD	UMATILLA AVE	Fixed object	Fixed Object or Other Object	Property Damage Only	Reckless Driving (per PAR)	Physical illness	Fixed object, unknown type.	5 - No Apparent Injury

KABCO	CRASH_ID	CRASH_DATE	RTE_NM	MP_NO	ST_FULL_NAME	ISECT_ST_FULL_NM	CRASH_TYP_LONG_DESC	COLLIS_TYP_LONG_DESC	CRASH_SVRTY_LONG_DESC	CRASH_CAUSE_1_LONG_DESC	CRASH_CAUSE_2_LONG_DESC	CRASH_EVNT_1_LONG_DESC	T, UJ
	1888691	10/15/20			COLUMBIA BLVD	WILLAMETTE AVE	Fixed object	Fixed Object or Other Object	Non-Fatal Injury	Too fast for conditions (not exceed posted speed)	Made improper turn	Curb (also narrow sidewalks on bridges)	4 - Possible Injury Crash (C)
	1901567	7/19/20			COLUMBIA BLVD	WILLAMETTE AVE	From opposite direction-one left turn,one straight	Turning Movement	Property Damage Only	Made improper turn	Did not yield right-of-way		5 - No Apparent Injury/PDO Crash (O)
O	1691805	5/25/16			DARK CANYON AVE	POWER LINE RD	Fixed Object	Fixed Object or Other Object	Property Damage Only	Too fast for conditions (not exceed posted speed)	Careless Driving (per PAR)	Curb (also narrow sidewalks on bridges)	5 - No Apparent Injury
B	1718021	10/7/17			EISELE ST	6TH ST	Fixed Object	Fixed Object or Other Object	Non-Fatal Injury	Mechanical defect		Building or other structure	3 - Suspected Minor Injury
O	1804176	3/27/18			EISELE ST	6TH ST	Entering at angle - one vehicle stopped	Turning Movement	Property Damage Only	Did not yield right-of-way			5 - No Apparent Injury
O	1817749	8/27/18			ELDERBERRY CT	LEWIS ST	Parked motor vehicle	Turning Movement	Property Damage Only	Made improper turn		Vehicle forced by impact into another vehicle, pedalcyclist or pedestrian	5 - No Apparent Injury
C	1657701	8/17/16			G ST	6TH ST	Entering at angle - all others	Parking Maneuver	Non-Fatal Injury	Did not yield right-of-way			4 - Possible Injury
	1900939	8/16/20			J ST	6TH ST	From opposite direction-all others incl. parking	Backing	Property Damage Only	Did not yield right-of-way			5 - No Apparent Injury/PDO Crash (O)
	1901903	6/25/20			JOHN DAY ST	EL MONTE ST	Parked motor vehicle	Sideswipe - Overtaking	Property Damage Only	Did not yield right-of-way		Vehicle forced by impact into another vehicle, pedalcyclist or pedestrian	5 - No Apparent Injury/PDO Crash (O)
O	1818315	10/14/18			K ST	7TH ST	Fixed object	Fixed Object or Other Object	Property Damage Only	Inattention	Drove left of center on two-way road; straddling	Stop or yield sign	5 - No Apparent Injury
O	1750720	10/12/17			L ST	8TH ST	Entering at angle - all others	Turning movement	Property Damage Only	Made improper turn			5 - No Apparent Injury
O	1749299	3/12/17			MONROE ST	HAMILTON ST	Parked motor vehicle	Backing	Property Damage Only	Other improper driving			5 - No Apparent Injury
O	1868180	12/26/19			NACHES AVE	WALLA WALLA ST	Fixed object	Fixed Object or Other Object	Property Damage Only	Other improper driving		Curb (also narrow sidewalks on bridges)	5 - No Apparent Injury
O	1861990	7/25/19			PIERCE AVE	ADAMS CT	Parked motor vehicle	Sideswipe - Overtaking	Property Damage Only	Careless Driving (per PAR)	Inattention	Mailbox	5 - No Apparent Injury
C	1841775	10/2/19			PIERCE AVE	POWER LINE RD	Entering at angle - all others	Turning Movement	Non-Fatal Injury	Passed stop sign or red flasher	Made improper turn	Vertical grade / hill present at crash location	4 - Possible Injury
O	1691381	8/9/16			POWER LINE RD	CAROLINA RD	Fixed Object	Fixed Object or Other Object	Property Damage Only	Too fast for conditions (not exceed posted speed)		Curb (also narrow sidewalks on bridges)	5 - No Apparent Injury
	1880934	5/25/20			POWER LINE RD	DARK CANYON AVE	Fixed object	Fixed Object or Other Object	Non-Fatal Injury	Other improper driving		Cut slope or ditch embankment	4 - Possible Injury Crash (C)
	1901274	1/16/20			POWER LINE RD	DARK CANYON AVE	From opposite direction - both going straight	Head-On	Property Damage Only	Drove left of center on two-way road; straddling	Did not yield right-of-way	Sliding or swerving due to wet, icy, slippery or loose surface (not gravel)	5 - No Apparent Injury/PDO Crash (O)
	1900481	2/3/20			POWER LINE RD	EAGLE AVE	Fixed object	Fixed Object or Other Object	Property Damage Only	Phantom / Non-contact Vehicle		Curb (also narrow sidewalks on bridges)	5 - No Apparent Injury/PDO Crash (O)
O	1691672	4/16/16			POWER LINE RD	HAMILTON ST	Overtaken	Non-collision	Property Damage Only	Driver drowsy/fatigued/sleepy			5 - No Apparent Injury
	1901520	7/13/20			POWER LINE RD	JEFFERSON ST	From same direction - one stopped	Rear-End	Property Damage Only	Inattention	Failed to avoid vehicle ahead	Vehicle forced by impact into another vehicle, pedalcyclist or pedestrian	5 - No Apparent Injury/PDO Crash (O)
O	1817873	11/5/18			POWER LINE RD	MARTIN DR	Fixed object	Fixed Object or Other Object	Property Damage Only	Other improper driving		Leading edge of guardrail	5 - No Apparent Injury
C	1777852	3/17/18			POWER LINE RD	MONROE ST	From opposite direction - both going straight	Sideswipe - Meeting	Non-Fatal Injury	Physical illness	Drove left of center on two-way road; straddling		4 - Possible Injury
O	1749810	6/22/17			POWER LINE RD	MONROE ST	Animal	Miscellaneous	Property Damage Only	Other (not improper driving)		Deer or elk, wapiti	5 - No Apparent Injury

KABCO	CRASH_ID	CRASH_DATE	RTE_NM	MP_NO	ST_FULL_NAME	ISECT_ST_FULL_NM	CRASH_TYP_LONG_DESC	COLLIS_TYP_LONG_DESC	CRASH_SVRTY_LONG_DESC	CRASH_CAUSE_1_LONG_DESC	CRASH_CAUSE_2_LONG_DESC	CRASH_EVNT_1_LONG_DESC	T, UJ
	1877140	10/19/20			POWER LINE RD	MONROE ST	Fixed object	Fixed Object or Other Object	Non-Fatal Injury	Inattention	Too fast for conditions (not exceed posted speed)	Building or other structure	2 - Suspected Serious Injury (A)
A	1656463	4/9/16			POWER LINE RD	PINE TREE LN	Entering at angle - all others	Angle	Non-Fatal Injury	Did not yield right-of-way			2 - Suspected Serious Injury
C	1718058	10/31/17			POWER LINE RD	PINE TREE LN	From same direction - one turn, one straight	Turning movement	Non-Fatal Injury	Improper overtaking			4 - Possible Injury
O	1805109	6/30/18			POWER LINE RD	RADAR RD	Fixed object	Fixed Object or Other Object	Property Damage Only	Inattention	Drove left of center on two-way road; straddling	Other sign, including street signs	5 - No Apparent Injury
O	1818237	11/18/18			POWER LINE RD	SPARROW AVE	Overtaken	Non-collision	Property Damage Only	Driver drowsy/fatigued/sleepy	Drove left of center on two-way road; straddling		5 - No Apparent Injury
O	1803928	3/24/18			RIO SENDA DR	EL MONTE ST	Parked motor vehicle	Sideswipe - Overtaking	Property Damage Only	Careless Driving (per PAR)	Drove left of center on two-way road; straddling		5 - No Apparent Injury
O	1750572	9/24/17			RIO SENDA DR	EL MONTE ST	Parked motor vehicle	Sideswipe - Overtaking	Property Damage Only	Careless Driving (per PAR)	Drove left of center on two-way road; straddling		5 - No Apparent Injury
O	1673099	1/6/16			RIO SENDA DR	EL MONTE ST	Parked motor vehicle	Rear-End	Property Damage Only	Drove left of center on two-way road; straddling		Curve present at crash location	5 - No Apparent Injury
O	1749542	5/25/17			RIVER RD	7TH ST	From same direction - one stopped	Rear-End	Property Damage Only	Followed too closely			5 - No Apparent Injury
O	1818295	10/2/18			RIVER RD	7TH ST	From same direction - one stopped	Rear-End	Property Damage Only	Inattention	Failed to avoid vehicle ahead	Vehicle forced by impact into another vehicle, pedalcyclist or pedestrian	5 - No Apparent Injury
C	1841097	6/1/19			RIVER RD	8TH ST	From same direction - both going straight	Rear-End	Non-Fatal Injury	Failed to avoid vehicle ahead			4 - Possible Injury
	1888448	11/24/20			RIVER RD	8TH ST	From same direction - one stopped	Rear-End	Non-Fatal Injury	Careless Driving (per PAR)	Inattention		4 - Possible Injury Crash (C)
C	1842398	9/8/19			RIVER RD	JONES SCOTT RD	From same direction - one stopped	Rear-End	Non-Fatal Injury	Careless Driving (per PAR)	Driving in excess of posted speed	Vehicle forced by impact into another vehicle, pedalcyclist or pedestrian	4 - Possible Injury
	1906659	12/9/20			RIVER RD	JONES SCOTT RD	From same direction - both going straight	Rear-End	Property Damage Only	Followed too closely			5 - No Apparent Injury/PDO Crash (O)
O	1751246	11/29/17			SLOAN AVE	6TH ST	Parked motor vehicle	Backing	Property Damage Only	Other improper driving			5 - No Apparent Injury
C	1748292	12/13/17			SPARROW AVE	BLUE JAY ST	Entering at angle - all others	Angle	Non-Fatal Injury	Did not yield right-of-way			4 - Possible Injury
O	1818233	11/14/18			STEPHENS AVE	TUCKER AVE	From same direction - one turn, one straight	Turning Movement	Property Damage Only	Made improper turn			5 - No Apparent Injury
O	1751225	8/13/17			WALLA WALLA ST	UMATILLA AVE	Parked motor vehicle	Sideswipe - Overtaking	Property Damage Only	Other improper driving			5 - No Apparent Injury
O	1804905	6/4/18			WILDWOOD LN	6TH ST	Parked motor vehicle	Miscellaneous	Property Damage Only	Other improper driving		Lost load, load moved or shifted	5 - No Apparent Injury
C	1717708	7/1/17			WILLAMETTE AVE	WALLA WALLA ST	Entering at angle - all others	Turning movement	Non-Fatal Injury	Inattention	Did not yield right-of-way		4 - Possible Injury
O	1750072	7/25/17			WILLAMETTE AVE	WALLA WALLA ST	Entering at angle - all others	Turning movement	Property Damage Only	Did not yield right-of-way			5 - No Apparent Injury
O	1750554	9/17/17			YAKIMA ST	DESCHUTES AVE	Parked motor vehicle	Sideswipe - Overtaking	Property Damage Only	Reckless Driving (per PAR)	Drove left of center on two-way road; straddling		5 - No Apparent Injury
O	1749789	6/17/17			YAKIMA ST	DESCHUTES AVE	Parked motor vehicle	Rear-End	Property Damage Only	Driver drowsy/fatigued/sleepy	Careless Driving (per PAR)	Vehicle forced by impact into another vehicle, pedalcyclist or pedestrian	5 - No Apparent Injury

Appendix F
Traffic Forecast Details

Historical Average Annual Daily Traffic

	US 730	I-82	
1998	2369	14514	
1999	2438	15438	
2000	2472	15057	
2001	2534	15291	
2002	2525	16093	
2003	2459	16437	
2004	2426	16306	
2005	2465	16307	
2006	2410	16542	
2007	2459	16973	
2008	2354	16364	
2009	2491	17136	
2010	2452	17854	
2011	2547	18100	
2012	2775	17880	
2013	2415	18487	
2014	2792	18997	
2015	2746	20465	
2016	3121	21700	
2017	2803	21600	
2018	3263	21528	
2019	3313	21595	
2020	2247	20908	
2021	3793	24536	
01-2021	1.496843	1.604604	
00-2020	0.908981	1.38859	
99-2019	1.358901	1.3988211	20-year growth, external
14-2019	1.186605	1.1367584	
09-2019	1.329988	1.2602124	

1.5%/year for 21 years = 137%
 used at external stations on US 730 west and east

**Umatilla Transportation System Plan Update
PM Peak Period Turning Movement Volumes - US 730 Corridor**

Brownell/3rd (Intersection #1)

	Northbound			Southbound			Eastbound			Westbound			Total Volume	
	Left	Thru	Right	Left	Thru	Right	Left	Thru	Right	Left	Thru	Right	Hourly	
2022 May PM Peak Hour	37	0	21	0	0	0	0	21	24	14	19	0	136	
Existing PM Pk Hr w/Seasonal Adj	40	0	25	0	0	0	0	25	25	15	20	0	150	
2043 @1.5%/year	55	0	34	0	0	0	0	34	34	21	27	0	205	137%
2043 Forecast (rounded)	55		35	0	0	0	0	35	35	20	25		205	137%

Powerline/6th (US 730) (Intersection #2)

	Northbound			Southbound			Eastbound			Westbound			Total	
	Left	Thru	Right	Left	Thru	Right	Left	Thru	Right	Left	Thru	Right	Volume	PHF
2022 May PM Peak Hour	48	0	103	0	0	0	381	65	147	302	0	0	1046	
Existing PM Pk Hr w/Seasonal Adj	55	0	115	0	0	0	425	75	165	340	0	0	1175	0.94
South Hill Additions	184		227						154	284			849	
East End Industrial Additions			2				6			24	50		82	
TOTAL	239	0	344	0	0	0	431	229	473	390	0	0	2106	
2043 @1.5%/year	75	0	157	0	0	0	581	103	226	465	0	0	1606	137%
2043 Forecast (rnd&bal)	240	0	345				455	230	475	390			2135	182%
	IN	OUT		IN	OUT		IN	OUT	IN	OUT			IN	OUT
	585	0		0	705		685	800	865	630			2135	2135

Switzler/6th (US 730) (Intersection #3)

2022 May PM Peak Hour	10	2	12	17	1	14	18	488	10	29	429	21	1051	
Existing PM Pk Hr w/Seasonal Adj	10	2	15	20	1	15	20	545	10	30	480	25	1173	0.92
South Hill Additions	6					9	8	215	4		269		511	
East End Industrial Additions			0	0			8		5	74	4		91	
TOTAL	16	2	15	20	1	24	28	768	14	35	823	29	1775	
2043 @1.5%/year	14	3	21	27	1	21	27	745	14	41	656	34	1604	137%
2043 Forecast (rnd&bal)	15	5	25	25	2	25	30	770	15	40	825	35	1812	154%
	IN	OUT		IN	OUT		IN	OUT	IN	OUT			IN	OUT
	45	70		52	57		815	820	900	865			1812	1812

Umatilla River Road (County Road 1275)/6th (US 730) (Intersection #4)

	Northbound			Southbound			Eastbound			Westbound			Total	
	Left	Thru	Right	Left	Thru	Right	Left	Thru	Right	Left	Thru	Right	Volume	PHF
2022 May PM Peak Hour	111	0	82	0	0	0	0	431	138	94	408	0	1264	
Existing PM Pk Hr w/Seasonal Adj	125	0	90	0	0	0	0	485	155	105	455	0	1415	0.92
South Hill Additions	58							163	52		211		484	
East End Industrial Additions			1				8		19	83			111	
TOTAL	183	0	91	0	0	0	0	656	207	124	749	0	2010	
2043 @1.5%/year	171	0	123	0	0	0	0	663	212	144	622	0	1934	137%
2043 Forecast (rnd&bal)	185	0	125					665	210	145	750		2080	147%
	IN	OUT		IN	OUT		IN	OUT	IN	OUT			IN	OUT
	310	0		0	355		875	790	895	935			2080	2080

Brownelle/6th (US 730) (Intersection #5)

	Northbound			Southbound			Eastbound			Westbound			Total	
	Left	Thru	Right	Left	Thru	Right	Left	Thru	Right	Left	Thru	Right	Volume	PHF
2022 May PM Peak Hour	8	3	36	109	3	18	23	542	2	8	610	43	1405	
Existing PM Pk Hr w/Seasonal Adj	10	5	40	120	5	20	25	605	2	10	685	50	1577	0.94
South Hill Additions	3					6	7	156	1		202		375	
East End Industrial Additions			1	2			9		1	102	7		122	
TOTAL	13	5	41	122	5	26	32	770	3	11	989	57	2074	
2043 @1.5%/year	14	7	55	164	7	27	34	827	3	14	936	68	2156	137%
2043 Forecast (rnd&bal)	15	5	55	165	5	25	35	830	5	15	990	70	2215	140%
	IN	OUT		IN	OUT		IN	OUT	IN	OUT			IN	OUT
	75	110		195	25		870	1050	1075	1030			2215	2215

I-82 EB ramps (southbound)/6th (US 730) (Intersection #6)

	Northbound			Southbound			Eastbound			Westbound			Total	
	Left	Thru	Right	Left	Thru	Right	Left	Thru	Right	Left	Thru	Right	Volume	PHF
2022 May PM Peak Hour	0	0	0	275	2	304	0	590	97	60	357	0	1685	
Existing PM Pk Hr w/Seasonal Adj	0	0	0	310	2	340	0	660	110	65	400	0	1887	0.94
South Hill Additions								134	22		109		358	
East End Industrial Additions				5				11		19	110		145	
TOTAL	0	0	0	315	2	433	0	805	132	84	619	0	2390	
2043 @1.5%/year	0	0	0	424	3	465	0	902	150	89	547	0	2580	137%
2043 Forecast (rnd&bal)				425	5	465	0	900	150	90	610		2645	140%
	IN	OUT		IN	OUT		IN	OUT	IN	OUT			IN	OUT
	0	0		895	245		1050	1325	700	1075			2645	2645

I-82 WB ramps (northbound)/6th (US 730) (Intersection #7)

	Northbound			Southbound			Eastbound			Westbound			Total	
	Left	Thru	Right	Left	Thru	Right	Left	Thru	Right	Left	Thru	Right	Volume	PHF
2022 May PM Peak Hour	25	1	111	0	0	0	272	593	0	0	392	419	1813	
Existing PM Pk Hr w/Seasonal Adj	30	1	125	0	0	0	305	665	0	0	440	470	2036	0.93
South Hill Additions	7						42	92			102		243	
East End Industrial Additions			3					16		129	137		285	
TOTAL	37	1	128	0	0	0	347	773	0	0	671	607	2564	
2043 @1.5%/year	41	1	171	0	0	0	417	909	0	0	602	643	2783	137%
2043 Forecast (rnd&bal)	40	2	170				415	910			660	645	2842	140%
	IN	OUT		IN	OUT		IN	OUT	IN	OUT			IN	OUT
	212	1062		0	0		1325	1080			1305	700	2842	2842

US 395/Devore Rd/6th St (US 730) (Intersection #8)

	Northbound			Southbound			Eastbound			Westbound			Total Volume	PHF
	Left	Thru	Right	Left	Thru	Right	Left	Thru	Right	Left	Thru	Right		
2022 May PM Peak Hour	418	9	222	5	12	37	6	247	397	220	339	4	1916	
Existing PM Pk Hr w/Seasonal Adj	470	10	250	5	15	40	5	275	445	245	380	5	2145	0.89
South Hill Additions	54						5	1	35	56	44		195	
East End Industrial Additions			17	0				19		173	266	3	478	
TOTAL	524	10	267	5	15	45	6	329	501	418	690	8	2818	
2043 @1.5%/year	643	14	342	7	21	55	7	376	608	335	519	7	2932	137%
2043 Forecast (rnd&bal)	625	15	335	10	20	55	10	380	610	420	690	10	3180	148%
	IN	OUT		IN	OUT		IN	OUT		IN	OUT		IN	OUT
	975	35		85	1050		1000	725		1120	1370		3180	3180

Columbia/6th (US 730) (Intersection #9)

	Northbound			Southbound			Eastbound			Westbound			Total Volume	PHF
	Left	Thru	Right	Left	Thru	Right	Left	Thru	Right	Left	Thru	Right		
2022 May PM Peak Hour	0	0	0	1	0	114	0	444	0	0	482	0	1041	
Existing PM Pk Hr w/Seasonal Adj	0	0	0	1	0	130	0	495	0	0	540	0	1166	0.81
South Hill Additions						8		35			36		79	
East End Industrial Additions								37			442		479	
TOTAL	0	0	0	1	0	138	0	567	0	0	1018	0	1724	
2043 @1.5%/year	0	0	0	1	0	178	0	677	0	0	738	0	1594	137%
2043 Forecast (rnd&bal)				5	0	140		690			1010	0	1845	158%
	IN	OUT		IN	OUT		IN	OUT		IN	OUT		IN	OUT
	0	0		145	0		690	695		1010	1150		1845	1845

Willamette/6th (US 730) (Intersection #10)

	Northbound			Southbound			Eastbound			Westbound			Total Volume	PHF
	Left	Thru	Right	Left	Thru	Right	Left	Thru	Right	Left	Thru	Right		
2022 May PM Peak Hour	0	0	0	29	0	146	303	142	0	0	338	70	1028	
Existing PM Pk Hr w/Seasonal Adj	0	0	0	30	0	165	340	160	0	0	380	80	1155	0.83
South Hill Additions						11	24	11			25		71	
East End Industrial Additions				8				37			442	91	578	
TOTAL	0	0	0	38	0	176	364	208	0	0	847	171	1804	
2043 @1.5%/year	0	0	0	41	0	226	465	219	0	0	519	109	1579	137%
2043 Forecast (rnd&bal)				40	0	200	425	270			840	170	1945	168%
	IN	OUT		IN	OUT		IN	OUT		IN	OUT		IN	OUT
	0	595		240	0		695	310		1010	1040		1945	1945

Bud Draper/6th St (US 730) (Intersection #11)

	Northbound			Southbound			Eastbound			Westbound			Total Volume	PHF
	Left	Thru	Right	Left	Thru	Right	Left	Thru	Right	Left	Thru	Right		
2022 May PM Peak Hour	0	0	0	11	0	35	7	160	0	0	368	3	584	
Existing PM Pk Hr w/Seasonal Adj	0	0	0	10	0	40	10	180	0	0	410	5	655	0.82
South Hill Additions						2	0	11			23		36	
East End Industrial Additions				3				45			533	4	585	
TOTAL	0	0	0	13	0	42	10	236	0	0	966	9	1276	
2043 @1.5%/year	0	0	0	14	0	55	14	246	0	0	560	7	895	137%
2043 Forecast (rnd&bal)				15	0	55	15	295			950	10	1340	205%
	IN	OUT		IN	OUT		IN	OUT		IN	OUT		IN	OUT
	0	25		70	0		310	310		960	1005		1340	1340

Beach Access/ (US 730) (Intersection #12)

	Northbound			Southbound			Eastbound			Westbound			Total Volume	PHF
	Left	Thru	Right	Left	Thru	Right	Left	Thru	Right	Left	Thru	Right		
2022 May PM Peak Hour	0	0	0	33	0	179	16	157	0	0	115	3	503	
Existing PM Pk Hr w/Seasonal Adj	0	0	0	35	0	200	20	175	0	0	130	5	565	0.79
South Hill Additions						14	1	10			9		34	
East End Industrial Additions				99			537	48				9	693	
TOTAL	0	0	0	134	0	751	69	185	0	0	139	14	1292	
2043 @1.5%/year	0	0	0	48	0	273	27	239	0	0	178	7	772	137%
2043 Forecast (rnd&bal)				135	0	750	70	240			180	15	1390	246%
	IN	OUT		IN	OUT		IN	OUT		IN	OUT		IN	OUT
	0	85		885	0		310	375		195	930		1390	1390

Madison/Powerline (Intersection #13)

	Northbound			Southbound			Eastbound			Westbound			Total Volume	
	Left	Thru	Right	Left	Thru	Right	Left	Thru	Right	Left	Thru	Right	Hourly	
2022 May PM Peak Hour	8	145	0	0	160	11	12	0	4	0	0	0	340	
Existing PM Pk Hr w/Seasonal Adj	10	160	0	0	180	10	15	0	5	0	0	0	380	
South Hill Additions	15	323			249	142	83		15				827	
TOTAL	25	483	0	0	429	152	98	0	20	0	0	0	1207	
2043 @1.5%/year	14	219	0	0	246	14	21	0	7	0	0	0	519	137%
2043 Forecast (rounded)	25	485			430	150	100		20				1210	318%

Appendix G
Traffic Impact Analysis Guidelines

TRAFFIC IMPACT ANALYSIS (TIA):
(Zoning Code Supplementary Provisions, Section 10-11-10)

A. Purpose: The purpose of this section is to implement section 660-012-0045(2)(e) of the State Transportation Planning Rule that requires the City to adopt a process to apply conditions to specified land use proposals in order to minimize adverse impacts to and protect transportation facilities. This section establishes the standards for when a proposal must be reviewed for potential traffic impacts; when a Traffic Impact Analysis must be submitted with an application in order to determine whether conditions are needed to minimize impacts to and protect transportation facilities; what must be in a Traffic Impact Analysis; and who is qualified to prepare the analysis.

B. Applicability: A Traffic Impact Analysis shall be required to be submitted to the City with a land use application, when the following conditions apply:

1. The application involves one or more of the following actions:

a. A change in zoning or plan amendment designation; or

b. The proposal is projected to cause one or more of the following effects, which can be determined by field counts, site observation, traffic impact analysis or study, field measurements, crash history, Institute of Transportation Engineers Trip Generation Manual; and information and studies provided by the local reviewing jurisdiction and/or ODOT:

(1) An increase in site traffic volume generation by two hundred fifty (250) average daily trips (ADT) or more (or as required by the City Engineer). The latest edition of the Trip Generation Manual, published by the Institute of Transportation Engineers (ITE) shall be used as standards by which to gauge average daily vehicle trips; or

(2) An increase in use of adjacent streets by vehicles exceeding the twenty thousand (20,000) pound gross vehicle weight by ten (10) vehicles or more per day; or

(3) The location of the access driveway does not meet minimum intersection sight distance requirements, or is located where vehicles entering or leaving the property are restricted, or vehicles queue or hesitate, creating a safety hazard; or

(4) The location of the access driveway does not meet the access spacing standard of the roadway on which the driveway is located; or

(5) A change in internal traffic patterns that may cause safety problems, such as backup onto the highway or traffic crashes in the approach area.

C. Traffic Impact Analysis Requirements:

1. Preparation: A Traffic Impact Analysis shall be prepared by an Oregon registered professional engineer that is qualified to perform traffic engineering analysis and will be paid for by the applicant.

2. Transportation Planning Rule Compliance: See section 10-13-3, "Amendments To The Zoning Text Or Map", of this title.

3. Pre-Application Conference: The applicant will meet with the Umatilla Public Works Director and Planning Director prior to submitting an application that requires a Traffic Impact Analysis. The City has the discretion to determine the required elements of the TIA and the level

of analysis expected. The City shall also consult the Oregon Department of Transportation (ODOT) on analysis requirements when the site of the proposal is adjacent to or otherwise affects a State roadway.

D. Approval Criteria: When a Traffic Impact Analysis is required, approval of the proposal requires satisfaction of the following criteria:

1. Traffic Impact Analysis was prepared by an Oregon registered professional engineer qualified to perform traffic engineering analysis;

2. If the proposed action shall cause a significant effect pursuant to the Transportation Planning Rule, or other traffic hazard or negative impact to a transportation facility, the Traffic Impact Analysis shall include mitigation measures that meet the City's level-of-service and/or volume/capacity standards and are satisfactory to the City Engineer, and ODOT when applicable; and

3. The proposed site design and traffic and circulation design and facilities, for all transportation modes, including any mitigation measures, are designed to:

a. Have the least negative impact on all applicable transportation facilities;

b. Accommodate and encourage non-motor vehicular modes of transportation to the extent practicable;

c. Make the most efficient use of land and public facilities as practicable;

d. Provide the most direct, safe and convenient routes practicable between on-site destinations, and between on-site and off-site destinations; and

e. Otherwise comply with applicable requirements of this Code.

E. Conditions Of Approval: The City may deny, approve, or approve a proposal with appropriate conditions.

1. Where the existing transportation system is shown to be impacted by the proposed action, dedication of land for streets, transit facilities, sidewalks, bikeways, paths, or accessways may be required to ensure that the transportation system is adequate to handle the additional burden caused by the proposed action.

2. Where the existing transportation system is shown to be impacted by the proposed action, improvements such as paving, curbing, installation or contribution to traffic signals, construction of sidewalks, bikeways, accessways, paths, or streets that serve the proposed action may be required. (Ord. 830, 8-7-2018)

Appendix H
2043 No-Build Capacity Analysis Worksheets

HCS7 Two-Way Stop-Control Report

General Information		Site Information	
Analyst	Montgomery	Intersection	Brownell-Third
Agency/Co.	JUB Engineers	Jurisdiction	City of Umatilla
Date Performed	11/18/2022	East/West Street	County Rd 1275 (Third St)
Analysis Year	2043	North/South Street	Brownelle Blvd
Time Analyzed	PM Peak Hour - No-Build	Peak Hour Factor	0.81
Intersection Orientation	East-West	Analysis Time Period (hrs)	0.25
Project Description	Umatilla Transportation System Plan		

Lanes

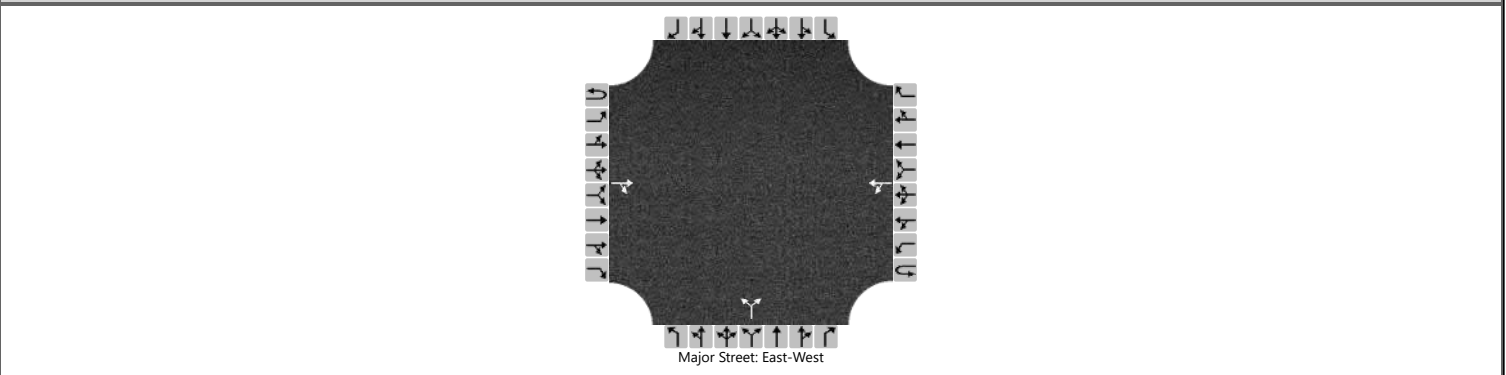

Vehicle Volumes and Adjustments

Approach	Eastbound				Westbound				Northbound				Southbound			
	U	L	T	R	U	L	T	R	U	L	T	R	U	L	T	R
Movement	1U	1	2	3	4U	4	5	6	7	8	9		10	11	12	
Priority																
Number of Lanes	0	0	1	0	0	0	1	0	0	1	0		0	0	0	
Configuration				TR		LT					LR					
Volume (veh/h)			35	35		20	25			55		35				
Percent Heavy Vehicles (%)						3				3		3				
Proportion Time Blocked																
Percent Grade (%)										3						
Right Turn Channelized																
Median Type Storage	Undivided															

Critical and Follow-up Headways

Base Critical Headway (sec)						4.1				7.1		6.2				
Critical Headway (sec)						4.13				7.03		6.53				
Base Follow-Up Headway (sec)						2.2				3.5		3.3				
Follow-Up Headway (sec)						2.23				3.53		3.33				

Delay, Queue Length, and Level of Service

Flow Rate, v (veh/h)						25					111					
Capacity, c (veh/h)						1503					873					
v/c Ratio						0.02					0.13					
95% Queue Length, Q ₉₅ (veh)						0.1					0.4					
Control Delay (s/veh)						7.4					9.7					
Level of Service (LOS)						A					A					
Approach Delay (s/veh)					3.4				9.7							
Approach LOS					A				A							

HCS7 Two-Way Stop-Control Report

General Information		Site Information	
Analyst	Montgomery	Intersection	Powerline/US 730
Agency/Co.	JUB Engineers	Jurisdiction	City of Umatilla
Date Performed	11/18/2022	East/West Street	6th Street (US 730)
Analysis Year	2043	North/South Street	Powerline Road
Time Analyzed	PM Peak Hour - No-Build	Peak Hour Factor	0.93
Intersection Orientation	East-West	Analysis Time Period (hrs)	0.25
Project Description	Umatilla Transportation System Plan		

Lanes

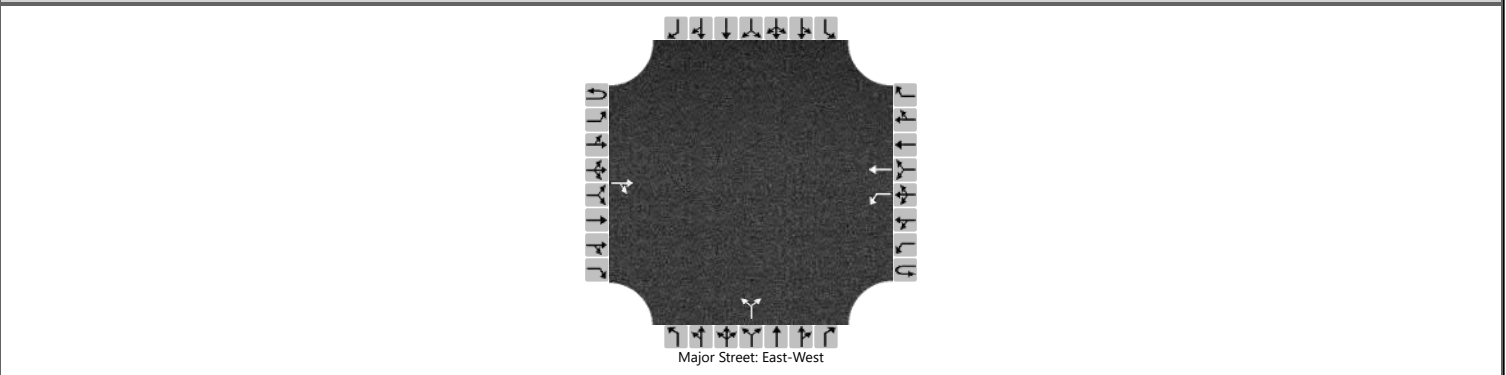

Vehicle Volumes and Adjustments

Approach	Eastbound				Westbound				Northbound				Southbound			
	U	L	T	R	U	L	T	R	U	L	T	R	U	L	T	R
Movement	1U	1	2	3	4U	4	5	6		7	8	9		10	11	12
Priority																
Number of Lanes	0	0	1	0	0	1	1	0		0	1	0		0	0	0
Configuration				TR		L	T				LR					
Volume (veh/h)			455	230		475	390			240		345				
Percent Heavy Vehicles (%)						3				3		3				
Proportion Time Blocked																
Percent Grade (%)										0						
Right Turn Channelized																
Median Type Storage	Undivided															

Critical and Follow-up Headways

Base Critical Headway (sec)						4.1				7.1		6.2				
Critical Headway (sec)						4.13				6.43		6.23				
Base Follow-Up Headway (sec)						2.2				3.5		3.3				
Follow-Up Headway (sec)						2.23				3.53		3.33				

Delay, Queue Length, and Level of Service

Flow Rate, v (veh/h)						511					629					
Capacity, c (veh/h)						865					56					
v/c Ratio						0.59					11.18					
95% Queue Length, Q ₉₅ (veh)						4.0					74.7					
Control Delay (s/veh)						15.0					4717.4					
Level of Service (LOS)						B					F					
Approach Delay (s/veh)					8.2				4717.4							
Approach LOS									F							

HCS7 Two-Way Stop-Control Report

General Information				Site Information			
Analyst	Montgomery			Intersection	Switzer/US 730		
Agency/Co.	JUB Engineers			Jurisdiction	City of Umatilla		
Date Performed	11/18/2022			East/West Street	6th Street (US 730)		
Analysis Year	2043			North/South Street	Switzer Ave		
Time Analyzed	PM Peak Hour - No-Build			Peak Hour Factor	0.92		
Intersection Orientation	East-West			Analysis Time Period (hrs)	0.25		
Project Description	Umatilla Transportation System Plan						

Lanes

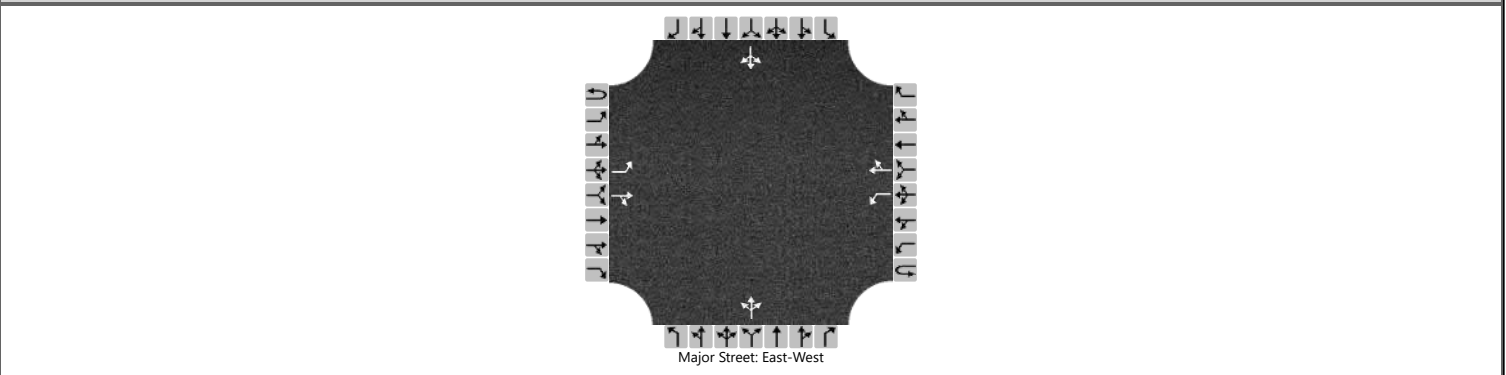

Vehicle Volumes and Adjustments

Approach	Eastbound				Westbound				Northbound				Southbound			
	U	L	T	R	U	L	T	R	U	L	T	R	U	L	T	R
Movement	1U	1	2	3	4U	4	5	6	7	8	9		10	11	12	
Priority																
Number of Lanes	0	1	1	0	0	1	1	0	0	1	0		0	1	0	
Configuration		L		TR		L		TR		LTR				LTR		
Volume (veh/h)		30	770	15		40	825	35		15	5	25		20	2	25
Percent Heavy Vehicles (%)		3				3				3	3	3		3	3	3
Proportion Time Blocked																
Percent Grade (%)									0				0			
Right Turn Channelized																
Median Type Storage	Undivided															

Critical and Follow-up Headways

Base Critical Headway (sec)		4.1				4.1				7.1	6.5	6.2		7.1	6.5	6.2
Critical Headway (sec)		4.13				4.13				7.13	6.53	6.23		7.13	6.53	6.23
Base Follow-Up Headway (sec)		2.2				2.2				3.5	4.0	3.3		3.5	4.0	3.3
Follow-Up Headway (sec)		2.23				2.23				3.53	4.03	3.33		3.53	4.03	3.33

Delay, Queue Length, and Level of Service

Flow Rate, v (veh/h)		33				43				49				51		
Capacity, c (veh/h)		728				782				87				77		
v/c Ratio		0.04				0.06				0.56				0.67		
95% Queue Length, Q ₉₅ (veh)		0.1				0.2				2.5				3.1		
Control Delay (s/veh)		10.2				9.9				90.0				117.6		
Level of Service (LOS)		B				A				F				F		
Approach Delay (s/veh)	0.4				0.4				90.0				117.6			
Approach LOS									F				F			

HCS7 Two-Way Stop-Control Report

General Information		Site Information	
Analyst	Montgomery	Intersection	Umatilla River Rd/US 730
Agency/Co.	JUB Engineers	Jurisdiction	City of Umatilla
Date Performed	11/18/2022	East/West Street	6th Street (US 730)
Analysis Year	2043	North/South Street	Umat. Riv Rd (Cnty 1275)
Time Analyzed	PM Peak Hour - No-Build	Peak Hour Factor	0.92
Intersection Orientation	East-West	Analysis Time Period (hrs)	0.25
Project Description	Umatilla Transportation System Plan		

Lanes

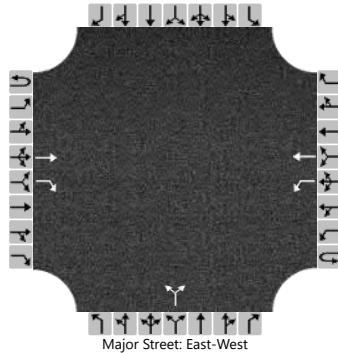

Vehicle Volumes and Adjustments

Approach	Eastbound				Westbound				Northbound				Southbound			
	U	L	T	R	U	L	T	R	U	L	T	R	U	L	T	R
Movement	1U	1	2	3	4U	4	5	6		7	8	9		10	11	12
Priority																
Number of Lanes	0	0	1	1	0	1	1	0		0	1	0		0	0	0
Configuration			T	R		L	T				LR					
Volume (veh/h)			665	210		145	750			185		125				
Percent Heavy Vehicles (%)						3				3		3				
Proportion Time Blocked																
Percent Grade (%)									0							
Right Turn Channelized	No															
Median Type Storage	Undivided															

Critical and Follow-up Headways

Base Critical Headway (sec)						4.1					7.1		6.2			
Critical Headway (sec)						4.13					6.43		6.23			
Base Follow-Up Headway (sec)						2.2					3.5		3.3			
Follow-Up Headway (sec)						2.23					3.53		3.33			

Delay, Queue Length, and Level of Service

Flow Rate, v (veh/h)						158						337				
Capacity, c (veh/h)						718						96				
v/c Ratio						0.22						3.50				
95% Queue Length, Q ₉₅ (veh)						0.8						33.8				
Control Delay (s/veh)						11.4						1218.6				
Level of Service (LOS)						B						F				
Approach Delay (s/veh)					1.8				1218.6							
Approach LOS									F							

Lanes, Volumes, Timings
5: 6th & Brownell

11/08/2022

Lane Group	EBL	EBT	EBR	WBL	WBT	WBR	NBL	NBT	NBR	SBL	SBT	SBR
Lane Configurations												
Traffic Volume (vph)	35	830	5	15	990	70	15	5	55	165	5	25
Future Volume (vph)	35	830	5	15	990	70	15	5	55	165	5	25
Ideal Flow (vphpl)	1900	1900	1900	1900	1900	1900	1900	1900	1900	1900	1900	1900
Storage Length (ft)	165		0	0		0	0		0	0		0
Storage Lanes	1		0	1		0	0		0	0		1
Taper Length (ft)	135			25			25			25		
Lane Util. Factor	1.00	0.95	0.95	1.00	0.95	0.95	1.00	1.00	1.00	1.00	1.00	1.00
Frt		0.999			0.990			0.901				0.850
Flt Protected	0.950			0.950				0.990			0.954	
Satd. Flow (prot)	1703	3402	0	1556	3081	0	0	1599	0	0	1119	997
Flt Permitted	0.950			0.950				0.933			0.687	
Satd. Flow (perm)	1703	3402	0	1556	3081	0	0	1507	0	0	806	997
Right Turn on Red			Yes			Yes			Yes			Yes
Satd. Flow (RTOR)		1			9			65				65
Link Speed (mph)		35			35			30				30
Link Distance (ft)		1078			236			248				460
Travel Time (s)		21.0			4.6			5.6				10.5
Peak Hour Factor	0.81	0.81	0.81	0.89	0.89	0.89	0.84	0.84	0.84	0.93	0.93	0.93
Heavy Vehicles (%)	6%	6%	6%	16%	16%	16%	6%	6%	6%	62%	62%	62%
Adj. Flow (vph)	43	1025	6	17	1112	79	18	6	65	177	5	27
Shared Lane Traffic (%)												
Lane Group Flow (vph)	43	1031	0	17	1191	0	0	89	0	0	182	27
Enter Blocked Intersection	No	No	No	No	No	No	No	No	No	No	No	No
Lane Alignment	Left	Left	Right	Left	Left	Right	Left	Left	Right	Left	Left	Right
Median Width(ft)		12			12			0				0
Link Offset(ft)		0			0			0				0
Crosswalk Width(ft)		16			16			16				16
Two way Left Turn Lane												
Headway Factor	1.00	1.00	1.00	1.00	1.00	1.00	1.00	1.00	1.00	1.00	1.00	1.00
Turning Speed (mph)	15		9	15		9	15		9	15		9
Number of Detectors	1	2		1	2		1	2		1	2	1
Detector Template	Left	Thru		Left	Thru		Left	Thru		Left	Thru	Right
Leading Detector (ft)	20	100		20	100		20	100		20	100	20
Trailing Detector (ft)	0	0		0	0		0	0		0	0	0
Detector 1 Position(ft)	0	0		0	0		0	0		0	0	0
Detector 1 Size(ft)	20	6		20	6		20	6		20	6	20
Detector 1 Type	Cl+Ex	Cl+Ex		Cl+Ex	Cl+Ex		Cl+Ex	Cl+Ex		Cl+Ex	Cl+Ex	Cl+Ex
Detector 1 Channel												
Detector 1 Extend (s)	0.0	0.0		0.0	0.0		0.0	0.0		0.0	0.0	0.0
Detector 1 Queue (s)	0.0	0.0		0.0	0.0		0.0	0.0		0.0	0.0	0.0
Detector 1 Delay (s)	0.0	0.0		0.0	0.0		0.0	0.0		0.0	0.0	0.0
Detector 2 Position(ft)		94			94			94				94
Detector 2 Size(ft)		6			6			6				6
Detector 2 Type		Cl+Ex			Cl+Ex			Cl+Ex				Cl+Ex
Detector 2 Channel												
Detector 2 Extend (s)		0.0			0.0			0.0				0.0
Turn Type	Prot	NA		Prot	NA		Perm	NA		Perm	NA	Perm
Protected Phases	1	6		5	2			4				8

Lanes, Volumes, Timings
5: 6th & Brownell

11/08/2022



Lane Group	EBL	EBT	EBR	WBL	WBT	WBR	NBL	NBT	NBR	SBL	SBT	SBR
Permitted Phases							4			8		8
Detector Phase	1	6		5	2		4	4		8	8	8
Switch Phase												
Minimum Initial (s)	7.0	10.0		7.0	10.0		7.0	7.0		7.0	7.0	7.0
Minimum Split (s)	13.0	40.5		13.0	36.5		36.5	36.5		37.0	37.0	37.0
Total Split (s)	13.0	49.0		13.0	49.0		38.0	38.0		38.0	38.0	38.0
Total Split (%)	13.0%	49.0%		13.0%	49.0%		38.0%	38.0%		38.0%	38.0%	38.0%
Maximum Green (s)	8.5	44.5		8.5	44.5		33.5	33.5		33.5	33.5	33.5
Yellow Time (s)	4.0	4.0		4.0	4.0		4.0	4.0		4.0	4.0	4.0
All-Red Time (s)	0.5	0.5		0.5	0.5		0.5	0.5		0.5	0.5	0.5
Lost Time Adjust (s)	0.0	0.0		0.0	0.0			0.0			0.0	0.0
Total Lost Time (s)	4.5	4.5		4.5	4.5			4.5			4.5	4.5
Lead/Lag	Lead	Lag		Lead	Lag							
Lead-Lag Optimize?	Yes	Yes		Yes	Yes							
Vehicle Extension (s)	3.5	5.6		3.5	4.6		3.5	3.5		5.0	5.0	5.0
Minimum Gap (s)	2.0	3.6		2.0	2.6		2.0	2.0		5.0	5.0	5.0
Time Before Reduce (s)	10.0	10.0		10.0	10.0		15.0	15.0		5.0	5.0	5.0
Time To Reduce (s)	10.0	10.0		10.0	10.0		15.0	15.0		5.0	5.0	5.0
Recall Mode	None	Min		None	Min		None	None		None	None	None
Walk Time (s)		7.0			7.0		7.0	7.0		7.0	7.0	7.0
Flash Dont Walk (s)		29.0			22.0		23.0	23.0		25.0	25.0	25.0
Pedestrian Calls (#/hr)		0			0		0	0		0	0	0
Act Effct Green (s)	7.9	44.5		8.3	49.6			33.0			33.0	33.0
Actuated g/C Ratio	0.08	0.45		0.08	0.50			0.33			0.33	0.33
v/c Ratio	0.32	0.68		0.13	0.77			0.16			0.68	0.07
Control Delay	49.8	24.6		55.0	20.5			9.8			43.5	0.7
Queue Delay	0.0	0.5		0.0	0.0			0.0			0.0	0.0
Total Delay	49.8	25.1		55.0	20.5			9.8			43.5	0.7
LOS	D	C		D	C			A			D	A
Approach Delay		26.1			21.0			9.8			38.0	
Approach LOS		C			C			A			D	
Queue Length 50th (ft)	26	267		11	368			10			99	0
Queue Length 95th (ft)	54	291		m23	459			39			#199	2
Internal Link Dist (ft)		998			156			168			380	
Turn Bay Length (ft)	165											
Base Capacity (vph)	145	1525		133	1544			551			272	379
Starvation Cap Reductn	0	0		0	0			0			0	0
Spillback Cap Reductn	0	163		0	0			2			0	0
Storage Cap Reductn	0	0		0	0			0			0	0
Reduced v/c Ratio	0.30	0.76		0.13	0.77			0.16			0.67	0.07

Intersection Summary

Area Type:	Other
Cycle Length:	100
Actuated Cycle Length:	99.3
Natural Cycle:	95
Control Type:	Actuated-Uncoordinated
Maximum v/c Ratio:	0.90
Intersection Signal Delay:	24.1
Intersection LOS:	C

Lanes, Volumes, Timings

5: 6th & Brownell

11/08/2022

Intersection Capacity Utilization 53.2% ICU Level of Service A

Analysis Period (min) 15

95th percentile volume exceeds capacity, queue may be longer.

Queue shown is maximum after two cycles.

m Volume for 95th percentile queue is metered by upstream signal.

















Splits and Phases: 5: 6th & Brownell



Lanes, Volumes, Timings

6: I-82 SB Entrance Ramp/I-82 SB Exit Ramp & 6th

11/08/2022

												
Lane Group	EBL	EBT	EBR	WBL	WBT	WBR	NBL	NBT	NBR	SBL	SBT	SBR
Lane Configurations												
Traffic Volume (vph)	0	900	150	90	610	0	0	0	0	425	5	465
Future Volume (vph)	0	900	150	90	610	0	0	0	0	425	5	465
Ideal Flow (vphpl)	1900	1900	1900	1900	1900	1900	1900	1900	1900	1900	1900	1900
Storage Length (ft)	0		0	110		0	0		0	0		0
Storage Lanes	0		0	1		0	0		0	0		1
Taper Length (ft)	25			45			25			25		
Lane Util. Factor	1.00	0.95	0.95	1.00	0.95	1.00	1.00	1.00	1.00	1.00	1.00	1.00
Frt		0.979										0.850
Flt Protected				0.950							0.953	
Satd. Flow (prot)	0	3047	0	1687	3374	0	0	0	0	0	1548	1380
Flt Permitted				0.950							0.953	
Satd. Flow (perm)	0	3047	0	1687	3374	0	0	0	0	0	1548	1380
Right Turn on Red			Yes			Yes			Yes			Yes
Satd. Flow (RTOR)		24										301
Link Speed (mph)		35			35			45				45
Link Distance (ft)		236			481			189				496
Travel Time (s)		4.6			9.4			2.9				7.5
Peak Hour Factor	0.85	0.85	0.85	0.91	0.91	0.91	0.92	0.92	0.92	0.93	0.93	0.93
Heavy Vehicles (%)	16%	16%	16%	7%	7%	7%	2%	2%	2%	17%	17%	17%
Adj. Flow (vph)	0	1059	176	99	670	0	0	0	0	457	5	500
Shared Lane Traffic (%)												
Lane Group Flow (vph)	0	1235	0	99	670	0	0	0	0	0	462	500
Enter Blocked Intersection	No	No	No	No	No	No	No	No	No	No	No	No
Lane Alignment	Left	Right	Right	Left	Right	R NA	Left	Left	Right	Left	Left	Right
Median Width(ft)		12			12			0				0
Link Offset(ft)		0			0			0				0
Crosswalk Width(ft)		16			16			16				16
Two way Left Turn Lane												
Headway Factor	1.00	1.00	1.00	1.00	1.00	1.00	1.00	1.00	1.00	1.00	1.00	1.00
Turning Speed (mph)	15		9	15		9	15		9	15		9
Number of Detectors		2		1	2					1	2	1
Detector Template		Thru		Left	Thru					Left	Thru	Right
Leading Detector (ft)		100		20	100					20	100	20
Trailing Detector (ft)		0		0	0					0	0	0
Detector 1 Position(ft)		0		0	0					0	0	0
Detector 1 Size(ft)		6		20	6					20	6	20
Detector 1 Type		Cl+Ex		Cl+Ex	Cl+Ex					Cl+Ex	Cl+Ex	Cl+Ex
Detector 1 Channel												
Detector 1 Extend (s)		0.0		0.0	0.0					0.0	0.0	0.0
Detector 1 Queue (s)		0.0		0.0	0.0					0.0	0.0	0.0
Detector 1 Delay (s)		0.0		0.0	0.0					0.0	0.0	0.0
Detector 2 Position(ft)		94			94							94
Detector 2 Size(ft)		6			6							6
Detector 2 Type		Cl+Ex			Cl+Ex							Cl+Ex
Detector 2 Channel												
Detector 2 Extend (s)		0.0			0.0							0.0
Turn Type		NA		Prot	NA					Perm	NA	Perm
Protected Phases		6		5	2							8

Lanes, Volumes, Timings
 6: I-82 SB Entrance Ramp/I-82 SB Exit Ramp & 6th

11/08/2022



Lane Group	EBL	EBT	EBR	WBL	WBT	WBR	NBL	NBT	NBR	SBL	SBT	SBR
Permitted Phases										8		8
Detector Phase		6		5	2					8	8	8
Switch Phase												
Minimum Initial (s)		10.0		7.0	10.0					7.0	7.0	7.0
Minimum Split (s)		40.5		13.0	36.5					37.0	37.0	37.0
Total Split (s)		49.0		13.0	49.0					38.0	38.0	38.0
Total Split (%)		49.0%		13.0%	49.0%					38.0%	38.0%	38.0%
Maximum Green (s)		44.5		8.5	44.5					33.5	33.5	33.5
Yellow Time (s)		4.0		4.0	4.0					4.0	4.0	4.0
All-Red Time (s)		0.5		0.5	0.5					0.5	0.5	0.5
Lost Time Adjust (s)		0.0		0.0	0.0						0.0	0.0
Total Lost Time (s)		4.5		4.5	4.5						4.5	4.5
Lead/Lag		Lag		Lead	Lag							
Lead-Lag Optimize?		Yes		Yes	Yes							
Vehicle Extension (s)		5.6		3.5	4.6					5.0	5.0	5.0
Minimum Gap (s)		3.6		2.0	2.6					5.0	5.0	5.0
Time Before Reduce (s)		10.0		10.0	10.0					5.0	5.0	5.0
Time To Reduce (s)		10.0		10.0	10.0					5.0	5.0	5.0
Recall Mode		Min		None	Min					None	None	None
Walk Time (s)		7.0			7.0					7.0	7.0	7.0
Flash Dont Walk (s)		29.0			22.0					25.0	25.0	25.0
Pedestrian Calls (#/hr)		0			0					0	0	0
Act Effct Green (s)		44.5		8.3	49.6						33.0	33.0
Actuated g/C Ratio		0.45		0.08	0.50						0.33	0.33
v/c Ratio		0.90		0.70	0.40						0.90	0.76
Control Delay		19.9		71.0	17.6						54.3	19.9
Queue Delay		0.0		0.0	0.1						0.0	1.1
Total Delay		19.9		71.0	17.7						54.3	21.0
LOS		B		E	B						D	C
Approach Delay		19.9			24.6						37.0	
Approach LOS		B			C						D	
Queue Length 50th (ft)		386		63	151						277	112
Queue Length 95th (ft)		103		#140	200						#464	253
Internal Link Dist (ft)		156			401			109			416	
Turn Bay Length (ft)				110								
Base Capacity (vph)		1378		144	1685						522	665
Starvation Cap Reductn		1		0	0						0	0
Spillback Cap Reductn		0		0	206						0	45
Storage Cap Reductn		0		0	0						0	0
Reduced v/c Ratio		0.90		0.69	0.45						0.89	0.81

Intersection Summary

Area Type:	Other
Cycle Length:	100
Actuated Cycle Length:	99.3
Natural Cycle:	95
Control Type:	Actuated-Uncoordinated
Maximum v/c Ratio:	0.90
Intersection Signal Delay:	26.7
Intersection LOS:	C

Lanes, Volumes, Timings
 6: I-82 SB Entrance Ramp/I-82 SB Exit Ramp & 6th

11/08/2022

Lane Group	Ø1	Ø4
Permitted Phases		
Detector Phase		
Switch Phase		
Minimum Initial (s)	7.0	7.0
Minimum Split (s)	13.0	36.5
Total Split (s)	13.0	38.0
Total Split (%)	13%	38%
Maximum Green (s)	8.5	33.5
Yellow Time (s)	4.0	4.0
All-Red Time (s)	0.5	0.5
Lost Time Adjust (s)		
Total Lost Time (s)		
Lead/Lag	Lead	
Lead-Lag Optimize?	Yes	
Vehicle Extension (s)	3.5	3.5
Minimum Gap (s)	2.0	2.0
Time Before Reduce (s)	10.0	15.0
Time To Reduce (s)	10.0	15.0
Recall Mode	None	None
Walk Time (s)		7.0
Flash Dont Walk (s)		23.0
Pedestrian Calls (#/hr)		0
Act Effct Green (s)		
Actuated g/C Ratio		
v/c Ratio		
Control Delay		
Queue Delay		
Total Delay		
LOS		
Approach Delay		
Approach LOS		
Queue Length 50th (ft)		
Queue Length 95th (ft)		
Internal Link Dist (ft)		
Turn Bay Length (ft)		
Base Capacity (vph)		
Starvation Cap Reductn		
Spillback Cap Reductn		
Storage Cap Reductn		
Reduced v/c Ratio		
Intersection Summary		

Lanes, Volumes, Timings

6: I-82 SB Entrance Ramp/I-82 SB Exit Ramp & 6th

11/08/2022





Intersection Capacity Utilization 70.6% ICU Level of Service C

Analysis Period (min) 15

95th percentile volume exceeds capacity, queue may be longer.

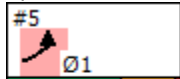
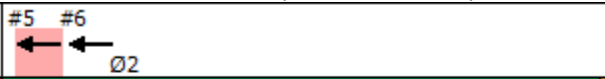
Queue shown is maximum after two cycles.

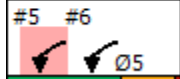















Splits and Phases: 6: I-82 SB Entrance Ramp/I-82 SB Exit Ramp & 6th

 <p>#5 Ø1</p>	 <p>#5 #6 Ø2</p>	 <p>#5 Ø4</p>
<p>13 s</p>	<p>49 s</p>	<p>38 s</p>
 <p>#5 #6 Ø5</p>	 <p>#5 #6 Ø6</p>	 <p>#5 #6 Ø8</p>
<p>13 s</p>	<p>49 s</p>	<p>38 s</p>

Lanes, Volumes, Timings

7: I-82 NB Exit Ramp/I-82 NB Entrance Ramp & 6th

11/08/2022

												
Lane Group	EBL	EBT	EBR	WBL	WBT	WBR	NBL	NBT	NBR	SBL	SBT	SBR
Lane Configurations												
Traffic Volume (vph)	415	910	0	0	660	645	40	5	170	0	0	0
Future Volume (vph)	415	910	0	0	660	645	40	5	170	0	0	0
Ideal Flow (vphpl)	1900	1900	1900	1900	1900	1900	1900	1900	1900	1900	1900	1900
Storage Length (ft)	110		0	0		0	0		215	0		0
Storage Lanes	1		0	0		0	0		1	0		0
Taper Length (ft)	70			25			25			25		
Lane Util. Factor	1.00	0.95	1.00	1.00	0.95	0.95	1.00	1.00	1.00	1.00	1.00	1.00
Frt					0.926				0.850			
Flt Protected	0.950							0.957				
Satd. Flow (prot)	1719	3438	0	0	3184	0	0	1478	1313	0	0	0
Flt Permitted	0.950							0.957				
Satd. Flow (perm)	1719	3438	0	0	3184	0	0	1478	1313	0	0	0
Link Speed (mph)		35			45			45				45
Link Distance (ft)		481			3338			681				572
Travel Time (s)		9.4			50.6			10.3				8.7
Peak Hour Factor	0.80	0.80	0.80	0.85	0.85	0.85	0.82	0.82	0.82	0.92	0.92	0.92
Heavy Vehicles (%)	5%	5%	5%	5%	5%	5%	23%	23%	23%	2%	2%	2%
Adj. Flow (vph)	519	1138	0	0	776	759	49	6	207	0	0	0
Shared Lane Traffic (%)												
Lane Group Flow (vph)	519	1138	0	0	1535	0	0	55	207	0	0	0
Enter Blocked Intersection	No	No	No	No	No	No	No	No	No	No	No	No
Lane Alignment	Left	Left	Right	Left	Left	Right	Left	Left	Right	Left	Left	Right
Median Width(ft)		12			12			0				0
Link Offset(ft)		0			0			0				0
Crosswalk Width(ft)		16			16			16				16
Two way Left Turn Lane												
Headway Factor	1.00	1.00	1.00	1.00	1.00	1.00	1.00	1.00	1.00	1.00	1.00	1.00
Turning Speed (mph)	15		9	15		9	15		9	15		9
Sign Control		Free			Free			Stop				Stop

Intersection Summary

Area Type:	Other
Control Type:	Unsignalized
Intersection Capacity Utilization	75.3%
ICU Level of Service	D
Analysis Period (min)	15

Lanes, Volumes, Timings
8: Devore & 6th

11/08/2022

Lane Group	EBL	EBT	EBR	WBL	WBT	WBR	NBL	NBT	NBR	SBL	SBT	SBR
Lane Configurations												
Traffic Volume (vph)	10	380	0	420	690	10	625	15	335	10	20	55
Future Volume (vph)	10	380	0	420	690	10	625	15	335	10	20	55
Ideal Flow (vphpl)	1900	1900	1900	1900	1900	1900	1900	1900	1900	1900	1900	1900
Storage Length (ft)	125		0	145		0	0		0	0		0
Storage Lanes	1		0	1		0	0		1	0		0
Taper Length (ft)	60			88			25			25		
Lane Util. Factor	1.00	0.95	1.00	1.00	0.95	0.95	1.00	1.00	1.00	1.00	1.00	1.00
Frt					0.998				0.850		0.913	
Flt Protected	0.950			0.950				0.953			0.994	
Satd. Flow (prot)	1770	3539	0	1770	3532	0	0	1775	1583	0	1690	0
Flt Permitted	0.950			0.950				0.563			0.683	
Satd. Flow (perm)	1770	3539	0	1770	3532	0	0	1049	1583	0	1162	0
Right Turn on Red			Yes			Yes			Yes			Yes
Satd. Flow (RTOR)					1				264		85	
Link Speed (mph)		45			45			45			45	
Link Distance (ft)		343			889			455			382	
Travel Time (s)		5.2			13.5			6.9			5.8	
Peak Hour Factor	0.82	0.82	0.82	0.72	0.72	0.72	0.90	0.90	0.90	0.42	0.42	0.42
Adj. Flow (vph)	12	463	0	583	958	14	694	17	372	24	48	131
Shared Lane Traffic (%)												
Lane Group Flow (vph)	12	463	0	583	972	0	0	711	372	0	203	0
Enter Blocked Intersection	No	No	No	No	No	No	No	No	No	No	No	No
Lane Alignment	Left	Left	Right	Left	Left	Right	Left	Left	Right	Left	Left	Right
Median Width(ft)		12			12			0			0	
Link Offset(ft)		0			0			0			0	
Crosswalk Width(ft)		16			16			16			16	
Two way Left Turn Lane												
Headway Factor	1.00	1.00	1.00	1.00	1.00	1.00	1.00	1.00	1.00	1.00	1.00	1.00
Turning Speed (mph)	15		9	15		9	15		9	15		9
Number of Detectors	1	2		1	2		1	2	1	1	2	
Detector Template	Left	Thru		Left	Thru		Left	Thru	Right	Left	Thru	
Leading Detector (ft)	20	100		20	100		20	100	20	20	100	
Trailing Detector (ft)	0	0		0	0		0	0	0	0	0	
Detector 1 Position(ft)	0	0		0	0		0	0	0	0	0	
Detector 1 Size(ft)	20	6		20	6		20	6	20	20	6	
Detector 1 Type	Cl+Ex	Cl+Ex		Cl+Ex	Cl+Ex		Cl+Ex	Cl+Ex	Cl+Ex	Cl+Ex	Cl+Ex	
Detector 1 Channel												
Detector 1 Extend (s)	0.0	0.0		0.0	0.0		0.0	0.0	0.0	0.0	0.0	
Detector 1 Queue (s)	0.0	0.0		0.0	0.0		0.0	0.0	0.0	0.0	0.0	
Detector 1 Delay (s)	0.0	0.0		0.0	0.0		0.0	0.0	0.0	0.0	0.0	
Detector 2 Position(ft)		94			94			94			94	
Detector 2 Size(ft)		6			6			6			6	
Detector 2 Type		Cl+Ex			Cl+Ex			Cl+Ex			Cl+Ex	
Detector 2 Channel												
Detector 2 Extend (s)		0.0			0.0			0.0			0.0	
Turn Type	Prot	NA		Prot	NA		Perm	NA	Perm	Perm	NA	
Protected Phases	5	2		1	6			8			4	
Permitted Phases							8		8	4		

Lanes, Volumes, Timings

8: Devore & 6th

11/08/2022



Lane Group	EBL	EBT	EBR	WBL	WBT	WBR	NBL	NBT	NBR	SBL	SBT	SBR
Detector Phase	5	2		1	6		8	8	8	4	4	
Switch Phase												
Minimum Initial (s)	8.0	10.0		8.0	10.0		8.0	8.0	8.0	7.0	7.0	
Minimum Split (s)	13.0	36.5		13.0	31.5		46.5	46.5	46.5	36.5	36.5	
Total Split (s)	13.0	38.0		35.0	60.0		77.0	77.0	77.0	77.0	77.0	
Total Split (%)	8.7%	25.3%		23.3%	40.0%		51.3%	51.3%	51.3%	51.3%	51.3%	
Maximum Green (s)	8.5	32.5		30.5	54.5		71.5	71.5	71.5	72.5	72.5	
Yellow Time (s)	4.0	5.0		4.0	5.0		5.0	5.0	5.0	4.0	4.0	
All-Red Time (s)	0.5	0.5		0.5	0.5		0.5	0.5	0.5	0.5	0.5	
Lost Time Adjust (s)	0.0	0.0		0.0	0.0		0.0	0.0	0.0		0.0	
Total Lost Time (s)	4.5	5.5		4.5	5.5		5.5	5.5	5.5		4.5	
Lead/Lag	Lead	Lag		Lead	Lag							
Lead-Lag Optimize?	Yes	Yes		Yes	Yes							
Vehicle Extension (s)	2.5	7.0		3.5	5.4		3.5	3.5	3.5	2.5	2.5	
Minimum Gap (s)	1.0	3.4		2.5	3.4		1.5	1.5	1.5	1.0	1.0	
Time Before Reduce (s)	5.0	15.0		5.0	15.0		10.0	10.0	10.0	5.0	5.0	
Time To Reduce (s)	5.0	15.0		5.0	15.0		10.0	10.0	10.0	5.0	5.0	
Recall Mode	None	Min		None	Min		None	None	None	None	None	
Walk Time (s)		7.0			7.0		7.0	7.0	7.0	7.0	7.0	
Flash Dont Walk (s)		24.0			19.0		34.0	34.0	34.0	25.0	25.0	
Pedestrian Calls (#/hr)		0			0		0	0	0	0	0	
Act Effct Green (s)	8.0	27.7		30.5	57.9			71.6	71.6		72.6	
Actuated g/C Ratio	0.06	0.19		0.21	0.40			0.49	0.49		0.50	
v/c Ratio	0.12	0.69		1.57	0.69			1.38	0.41		0.33	
Control Delay	69.9	60.4		306.2	40.2			213.0	8.1		14.2	
Queue Delay	0.0	0.0		0.0	0.0			0.0	0.0		0.0	
Total Delay	69.9	60.4		306.2	40.2			213.0	8.1		14.2	
LOS	E	E		F	D			F	A		B	
Approach Delay		60.6			139.9			142.6			14.2	
Approach LOS		E			F			F			B	
Queue Length 50th (ft)	11	216		~777	374			~886	54		62	
Queue Length 95th (ft)	32	249		#771	381			#1183	135		25	
Internal Link Dist (ft)		263			809			375			302	
Turn Bay Length (ft)	125			145								
Base Capacity (vph)	103	792		371	1411			516	913		622	
Starvation Cap Reductn	0	0		0	0			0	0		0	
Spillback Cap Reductn	0	0		0	0			0	0		0	
Storage Cap Reductn	0	0		0	0			0	0		0	
Reduced v/c Ratio	0.12	0.58		1.57	0.69			1.38	0.41		0.33	

Intersection Summary

Area Type:	Other
Cycle Length:	150
Actuated Cycle Length:	145.3
Natural Cycle:	150
Control Type:	Actuated-Uncoordinated
Maximum v/c Ratio:	1.57
Intersection Signal Delay:	121.8
Intersection Capacity Utilization	88.8%
Intersection LOS:	F
ICU Level of Service	E

Lanes, Volumes, Timings

8: Devore & 6th

11/08/2022

Analysis Period (min) 15

~ Volume exceeds capacity, queue is theoretically infinite.

Queue shown is maximum after two cycles.

95th percentile volume exceeds capacity, queue may be longer.

Queue shown is maximum after two cycles.

Splits and Phases: 8: Devore & 6th

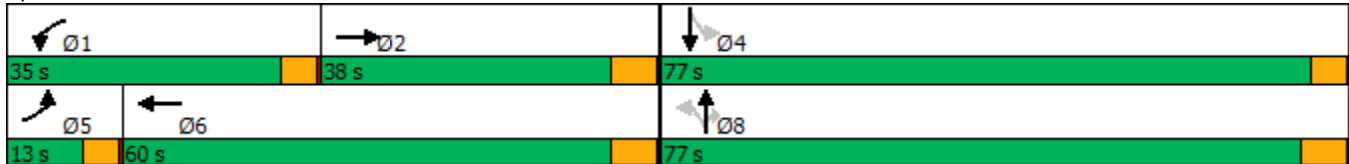

Intersection												
Int Delay, s/veh	24											
Movement	EBL	EBT	EBR	WBL	WBT	WBR	NBL	NBT	NBR	SBL	SBT	SBR
Lane Configurations	↘	↑↑			↑↑			↘	↗			
Traffic Vol, veh/h	415	910	0	0	660	645	40	5	170	0	0	0
Future Vol, veh/h	415	910	0	0	660	645	40	5	170	0	0	0
Conflicting Peds, #/hr	0	0	0	0	0	0	0	0	0	0	0	0
Sign Control	Free	Free	Free	Free	Free	Free	Stop	Stop	Stop	Stop	Stop	Stop
RT Channelized	-	-	None	-	-	None	-	-	None	-	-	None
Storage Length	110	-	-	-	-	-	-	-	215	-	-	-
Veh in Median Storage, #	-	0	-	-	0	-	-	0	-	-	0	-
Grade, %	-	0	-	-	0	-	-	0	-	-	0	-
Peak Hour Factor	80	80	80	85	85	85	82	82	82	92	92	92
Heavy Vehicles, %	5	5	5	5	5	5	23	23	23	2	2	2
Mvmt Flow	519	1138	0	0	776	759	49	6	207	0	0	0

Major/Minor	Major1	Major2	Minor1
Conflicting Flow All	1535	0	- - - 0 2564 3711 569
Stage 1	-	-	- - - 2176 2176 -
Stage 2	-	-	- - - 388 1535 -
Critical Hdwy	4.2	-	- - - 7.26 6.96 7.36
Critical Hdwy Stg 1	-	-	- - - 6.26 5.96 -
Critical Hdwy Stg 2	-	-	- - - 6.26 5.96 -
Follow-up Hdwy	2.25	-	- - - 3.73 4.23 3.53
Pot Cap-1 Maneuver	~ 415	- 0 0	- - ~ 16 ~ 3 416
Stage 1	-	- 0 0	- - 55 64 -
Stage 2	-	- 0 0	- - 597 145 -
Platoon blocked, %	-	-	- -
Mov Cap-1 Maneuver	~ 415	- - -	- - 0 0 416
Mov Cap-2 Maneuver	-	- - -	- - 0 0 -
Stage 1	-	- - -	- - 0 0 -
Stage 2	-	- - -	- - 597 0 -

Approach	EB	WB	NB
HCM Control Delay, s	50	0	
HCM LOS			-

Minor Lane/Major Mvmt	NBLn1	NBLn2	EBL	EBT	WBT	WBR
Capacity (veh/h)	-	416	~ 415	-	-	-
HCM Lane V/C Ratio	-	0.498	1.25	-	-	-
HCM Control Delay (s)	-	21.9	159.6	-	-	-
HCM Lane LOS	-	C	F	-	-	-
HCM 95th %tile Q(veh)	-	2.7	21.9	-	-	-

Notes
 ~: Volume exceeds capacity \$: Delay exceeds 300s +: Computation Not Defined *: All major volume in platoon

HCS7 Two-Way Stop-Control Report

General Information		Site Information	
Analyst	Montgomery	Intersection	Columbia Blvd/US 730
Agency/Co.	JUB Engineers	Jurisdiction	City of Umatilla
Date Performed	11/18/2022	East/West Street	6th Street (US 730)
Analysis Year	2043	North/South Street	Columbia Blvd
Time Analyzed	PM Peak Hour - No-Build	Peak Hour Factor	0.81
Intersection Orientation	East-West	Analysis Time Period (hrs)	0.25
Project Description	Umatilla Transportation System Plan		

Lanes

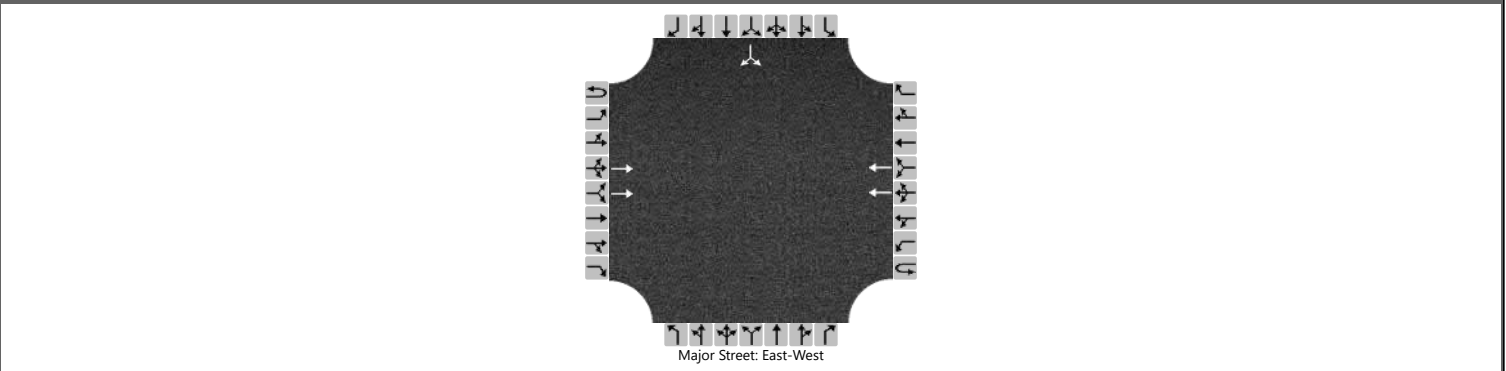

Vehicle Volumes and Adjustments

Approach	Eastbound				Westbound				Northbound				Southbound			
	U	L	T	R	U	L	T	R	U	L	T	R	U	L	T	R
Movement	1U	1	2	3	4U	4	5	6		7	8	9		10	11	12
Priority																
Number of Lanes	0	0	2	0	0	0	2	0		0	0	0		0	1	0
Configuration			T				T								LR	
Volume (veh/h)			690				1010							5		140
Percent Heavy Vehicles (%)														3		3
Proportion Time Blocked																
Percent Grade (%)														0		
Right Turn Channelized																
Median Type Storage	Undivided															

Critical and Follow-up Headways

Base Critical Headway (sec)															7.5		6.9
Critical Headway (sec)															6.86		6.96
Base Follow-Up Headway (sec)															3.5		3.3
Follow-Up Headway (sec)															3.53		3.33

Delay, Queue Length, and Level of Service

Flow Rate, v (veh/h)																	179
Capacity, c (veh/h)																	375
v/c Ratio																	0.48
95% Queue Length, Q ₉₅ (veh)																	2.5
Control Delay (s/veh)																	23.1
Level of Service (LOS)																	C
Approach Delay (s/veh)																	23.1
Approach LOS																	C

HCS7 Two-Way Stop-Control Report

General Information		Site Information	
Analyst	Montgomery	Intersection	Willamette/US 730
Agency/Co.	JUB Engineers	Jurisdiction	City of Umatilla
Date Performed	11/18/2022	East/West Street	6th Street (US 730)
Analysis Year	2043	North/South Street	Willamette St
Time Analyzed	PM Peak Hour - No-Build	Peak Hour Factor	0.83
Intersection Orientation	East-West	Analysis Time Period (hrs)	0.25
Project Description	Umatilla Transportation System Plan		

Lanes

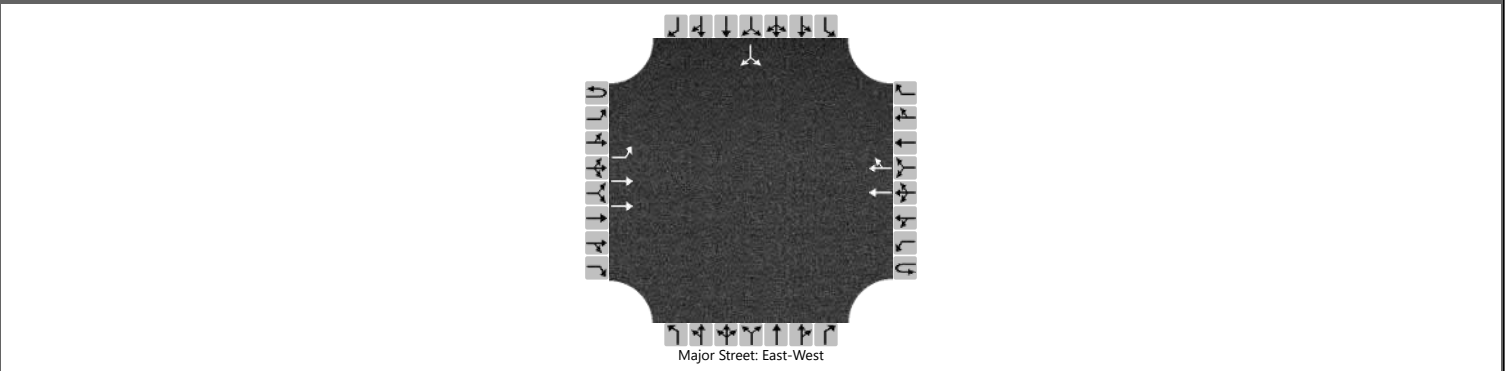

Vehicle Volumes and Adjustments

Approach	Eastbound				Westbound				Northbound				Southbound			
	U	L	T	R	U	L	T	R	U	L	T	R	U	L	T	R
Movement	1U	1	2	3	4U	4	5	6		7	8	9		10	11	12
Priority																
Number of Lanes	0	1	2	0	0	0	2	0	0	0	0	0	0	1	0	
Configuration		L	T				T	TR							LR	
Volume (veh/h)	0	425	270				840	170						40		200
Percent Heavy Vehicles (%)	3	3												3		3
Proportion Time Blocked																
Percent Grade (%)														0		
Right Turn Channelized																
Median Type Storage	Undivided															

Critical and Follow-up Headways

Base Critical Headway (sec)		4.1												7.5		6.9
Critical Headway (sec)		4.16												6.86		6.96
Base Follow-Up Headway (sec)		2.2												3.5		3.3
Follow-Up Headway (sec)		2.23												3.53		3.33

Delay, Queue Length, and Level of Service

Flow Rate, v (veh/h)		512													289		
Capacity, c (veh/h)		563													17		
v/c Ratio		0.91													17.08		
95% Queue Length, Q ₉₅ (veh)		11.0													37.0		
Control Delay (s/veh)		46.0													7673.5		
Level of Service (LOS)		E													F		
Approach Delay (s/veh)		28.1												7673.5			
Approach LOS													F				

HCS7 Two-Way Stop-Control Report

General Information		Site Information	
Analyst	Montgomery	Intersection	Bud Draper Rd/US 730
Agency/Co.	JUB Engineers	Jurisdiction	City of Umatilla
Date Performed	11/18/2022	East/West Street	6th Street (US 730)
Analysis Year	2043	North/South Street	Bud Draper Rd
Time Analyzed	PM Peak Hour - No-Build	Peak Hour Factor	0.82
Intersection Orientation	East-West	Analysis Time Period (hrs)	0.25
Project Description	Umatilla Transportation System Plan		

Lanes

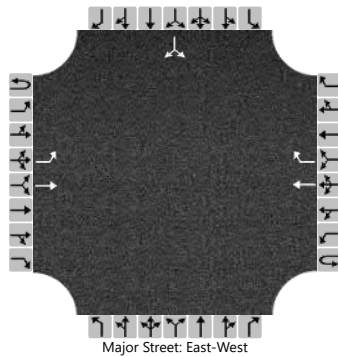

Vehicle Volumes and Adjustments

Approach	Eastbound				Westbound				Northbound				Southbound			
	U	L	T	R	U	L	T	R	U	L	T	R	U	L	T	R
Movement	1U	1	2	3	4U	4	5	6		7	8	9		10	11	12
Number of Lanes	0	1	1	0	0	0	1	1		0	0	0		0	1	0
Configuration		L	T				T	R							LR	
Volume (veh/h)		15	295				950	10						15		55
Percent Heavy Vehicles (%)		3												3		3
Proportion Time Blocked																
Percent Grade (%)														0		
Right Turn Channelized					No											
Median Type Storage	Undivided															

Critical and Follow-up Headways

Base Critical Headway (sec)		4.1												7.1		6.2
Critical Headway (sec)		4.13												6.43		6.23
Base Follow-Up Headway (sec)		2.2												3.5		3.3
Follow-Up Headway (sec)		2.23												3.53		3.33

Delay, Queue Length, and Level of Service

Flow Rate, v (veh/h)		18														85
Capacity, c (veh/h)		593														196
v/c Ratio		0.03														0.44
95% Queue Length, Q ₉₅ (veh)		0.1														2.0
Control Delay (s/veh)		11.3														36.8
Level of Service (LOS)		B														E
Approach Delay (s/veh)		0.5												36.8		
Approach LOS														E		

HCS7 Two-Way Stop-Control Report

General Information		Site Information	
Analyst	Montgomery	Intersection	Beach Access Rd/US 730
Agency/Co.	JUB Engineers	Jurisdiction	City of Umatilla
Date Performed	11/18/2022	East/West Street	6th Street (US 730)
Analysis Year	2043	North/South Street	Beach Access Rd
Time Analyzed	PM Peak Hour No-Build	Peak Hour Factor	0.79
Intersection Orientation	East-West	Analysis Time Period (hrs)	0.25
Project Description	Umatilla Transportation System Plan		

Lanes

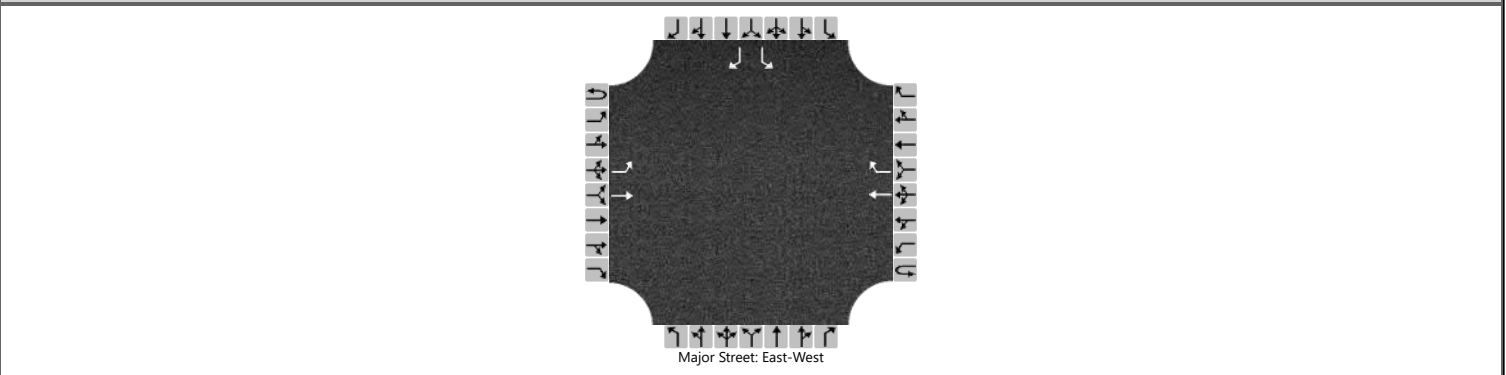

Vehicle Volumes and Adjustments

Approach	Eastbound				Westbound				Northbound				Southbound			
	U	L	T	R	U	L	T	R	U	L	T	R	U	L	T	R
Movement	1U	1	2	3	4U	4	5	6		7	8	9		10	11	12
Priority																
Number of Lanes	0	1	1	0	0	0	1	1		0	0	0		1	0	1
Configuration		L	T				T	R						L		R
Volume (veh/h)		70	240				180	15						135		750
Percent Heavy Vehicles (%)		3												3		3
Proportion Time Blocked																
Percent Grade (%)													0			
Right Turn Channelized					No								No			
Median Type Storage	Undivided															

Critical and Follow-up Headways

Base Critical Headway (sec)		4.1												7.1		6.2
Critical Headway (sec)		4.13												6.43		6.23
Base Follow-Up Headway (sec)		2.2												3.5		3.3
Follow-Up Headway (sec)		2.23												3.53		3.33

Delay, Queue Length, and Level of Service

Flow Rate, v (veh/h)		89												171		949
Capacity, c (veh/h)		1313												372		809
v/c Ratio		0.07												0.46		1.17
95% Queue Length, Q ₉₅ (veh)		0.2												2.3		29.6
Control Delay (s/veh)		7.9												22.6		110.8
Level of Service (LOS)		A												C		F
Approach Delay (s/veh)	1.8												97.3			
Approach LOS													F			

HCS7 Two-Way Stop-Control Report

General Information		Site Information	
Analyst	Montgomery	Intersection	Powerline/Madison
Agency/Co.	JUB Engineers	Jurisdiction	City of Umatilla
Date Performed	11/18/22	East/West Street	Madison Street
Analysis Year	2043	North/South Street	Powerline Road
Time Analyzed	PM Peak Hour - No-Build	Peak Hour Factor	0.90
Intersection Orientation	North-South	Analysis Time Period (hrs)	0.25
Project Description	Umatilla Transportation System Plan		

Lanes

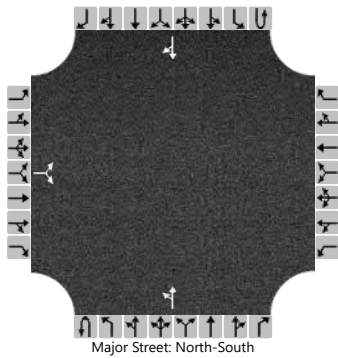

Vehicle Volumes and Adjustments

Approach	Eastbound				Westbound				Northbound				Southbound			
	U	L	T	R	U	L	T	R	U	L	T	R	U	L	T	R
Priority		10	11	12		7	8	9	1U	1	2	3	4U	4	5	6
Number of Lanes		0	1	0		0	0	0	0	0	1	0	0	0	1	0
Configuration			LR							LT						TR
Volume (veh/h)		100		20						25	485				430	150
Percent Heavy Vehicles (%)		3		3						3						
Proportion Time Blocked																
Percent Grade (%)		0														
Right Turn Channelized																
Median Type Storage		Undivided														

Critical and Follow-up Headways

Base Critical Headway (sec)		7.1		6.2						4.1						
Critical Headway (sec)		6.43		6.23						4.13						
Base Follow-Up Headway (sec)		3.5		3.3						2.2						
Follow-Up Headway (sec)		3.53		3.33						2.23						

Delay, Queue Length, and Level of Service

Flow Rate, v (veh/h)			133							28						
Capacity, c (veh/h)			231							936						
v/c Ratio			0.58							0.03						
95% Queue Length, Q ₉₅ (veh)			3.2							0.1						
Control Delay (s/veh)			40.0							9.0						
Level of Service (LOS)			E							A						
Approach Delay (s/veh)		40.0								0.8						
Approach LOS		E														

Appendix I
Public Involvement Information

Umatilla Transportation System Plan Update Public Involvement - Stakeholder Assessment

Overview

In April through June of 2022, The Langdon Group, a subsidiary of JUB Engineers specializing in public involvement and facilitation, conducted a series of stakeholder interviews for the Umatilla Transportation System Plan Update project. The goal of these interviews was to consult and collect direct feedback from local experts and prominent community members on the challenges and opportunities of Umatilla roadways. Stakeholders were identified in collaboration with the City and selected based on their ability to provide a cross-section of insight and expertise. In total, 8 interviews were conducted via Zoom and/or by phone based on the stakeholder's preference.

Overall, stakeholders felt that Umatilla roadways function well and meet the needs of their organizations and employees. All stakeholders commented that residential and commercial growth is of significant consideration for the area now and in the future. The majority of stakeholders identified the corridor of 730 (and its major intersections) as being the most important for safety and traffic flow improvements. The Downtown, South Hill and McNary neighborhoods were also commonly discussed as areas for priority consideration.

Additional feedback from the interviews centered around several main themes, including local growth, freight traffic, support for the current state of roadways and infrastructure, safety, priority issues and improvements, opportunities and long-term improvements, and miscellaneous items. Each of these are broken into detail below:

Expected Local Growth

- The fire department and police departments will likely expand.
- The Prison is unlikely to expand.
- The school district owns property on South Hill and is likely to build a new site there.
- Residential and economic growth are occurring, increased traffic and roadway impacts are expected.
- New data centers are expected at the current Amazon location and on South Hill.
- Expansion/widening of roads in the future will be difficult due to existing parallel electrical and pipeline infrastructure.

US 730 Corridor and Intersections

- Particularly at 730 and 82, current traffic flow is difficult at most times of the day. Most congested times of day are commuter hours between 6-7am, and 3:30-5pm.
- Current issues will be exacerbated by local residential and commercial growth
- Accidents occur frequently at the 730 and 82 interchange ramps.
- The absence of middle lanes and/or medians on 730 is frequently worrisome if not problematic.
- 730 to Beach Access Road is ok, with problems increasing moving west along the corridor.
- Visibility is poor with steep grade, and drivers exceed the speed limit.

Freight Traffic

- Volume of freight and semi traffic is high and increasing.
- The current location of the Port of Entry causes increased congestion and traffic flow issues.
 - Many supported relocation of the Port of Entry in order to separate freight and commuter traffic. (Potentially near rock quarry.)
- Increased freight traffic in McNary area; down Willamette Rd. Some confusion for freight trying to turn around in that area.
- High congestion on 395 causes loss of freight business. Trucks detour to side roads to avoid 395 and 84/82.
- The location and cumbersome process association with the weigh station is a deterrent for freight traffic and loses agricultural freight and economic growth for Oregon.
 - Consider a passport system to eliminate unnecessary and excessive fines.
- Freight traffic is the highest between July and August.
 - Minimize construction on Beach Access and Bud Draper Road during this time.
 - ODOT performs a gravel spray as a maintenance routine, which may impede or conflict with freight traffic during this time.
- Speeding is an issue, and greater enforcement for freight speed limits is needed.

Support for Current State of Roadways and Infrastructure

- Downtown Lighting is good, and important for pedestrian safety.
- Repaving of downtown corridor is good.
- The recently developed sidewalks and crosswalks are a welcome improvement and are used properly and frequently by pedestrians and children in downtown and accessing the high school.
- The schools are generally easy to access for emergency services.
- Improvements to Powerline corridor are appreciated and working well.
- Middle school parking lot is large enough and works well.
- General maintenance of roads and upkeep with growth is noted to be good, high quality.

Safety

- Powerline poses a threat to safety due to absence of sidewalks, mixed residential and industrial uses, narrow road, and lack of shoulder.
- Lighting around the 2-Rivers prison needs to be improved.
- Traffic control near Beach Access and Wanapuh Rd needs to be implemented to slow truck traffic and enforce adherence to reduced speed limit.
- Free range cattle is occasionally a safety issue <1 per year.
- River Road experiences casualties and safety issues due to limited visibility, sharp turns, and speeding.

Priority Issues and Improvements

- Reduce traffic in the downtown area.
 - Single lane traffic flow is problematic.
 - Slowing measures have worked some, but more may be needed included flashing pedestrian crosswalk signs.
- Find additional access to McNary neighborhood.

- Potentially East end of Bud Draper or connect to Devore on northwestern edge of the neighborhood.
- Major congestion occurs during school pick up and drop off times. Less students are walking or taking the bus, more individual car drop offs occur.
 - School district emergency planning for McNary is difficult due to limited access.
- Congestion in McNary is a common community complaint.
- Limited access to South Hill is worrisome for many:
 - Create a 2nd route to South Hill, potentially via Powerline and/or over the river.
 - Eliminate the “S” curve which connects Powerline to 730, north of South Hill as it slows down emergency response times.
 - Support for a foot bridge by South Hill and the high school
- Completing infrastructure (sidewalks, curbs, and gutter) for routes to and from schools.
- Improvements to Lind Road.
- The intersection of 6th and Columbia is a problematic one-way.
- The Port has no significant needs but supports prioritization of the needs of United Grain and Tidewater in the coming years.

Opportunities and long-term projects

- Expand parks and outdoor space near McNary.
- Beach Access Rd will be increasingly impacted with increase in industrial traffic.
 - Accidents were occurring on Beach Access with Amazon freight and employees from Two Rivers Correctional Institution.
- Improve bike-ped access from McNary to Downtown.
 - Take advantage of beautiful area by making a connection with a trails system.
- Areas in South Hill are unable to accommodate bus traffic for student pick up during ice events and cold months due to steep grade.
- Parking and transportation systems to support recreational and large community events.
- The City is in a good position, with a lot of funding opportunities, economic growth, and resources available.
- The intersection of 730 and 82 has potential to provide economic opportunity with design improvements, to attract business from through traffic, and represent Umatilla positively.

Miscellaneous

- Consider the various studies previously conducted and incorporate those findings. (Trail plans, studies to open Old Town for bike-ped use.)
- Hermiston is growing rapidly, may become a satellite community for the Tri-Cities. Collisions and safety concerns are increasing along 395 corridor south of Umatilla. A physical divider/median is needed.
- Have a plan for how to enforce improvements. Historically, the 82 interchange was intended to divert freight traffic from 395, however, without enforcement that intention was never fulfilled.
- The Port would like to work with the City to secure additional funds (grants, state, and federal funding, etc.)
- Retaining professionals for City planning and special studies will be key for quality long-lasting solutions.

GROWTH & FUTURE EXPANSIONS

- What kind of long-term plans do you have for business/location/facility/town? (*Interviewer guidance: could be expansion of service, expansion of buildings, increased hiring*)
- How does the Umatilla Transportation System Plan fit into these long-term plans?
- What do you need out of Umatilla Transportation System Plan to accomplish your long-term goals?

CHALLENGES & ISSUES

- What challenges do your organization/business staff and patrons experience with Umatilla roadways? (*Interviewer guidance: access, safety, congestion, etc. – ask for specific examples*)
- What are you hearing from your customers/employees/students about Umatilla roadways/traffic and how it is working for them?
- What issues do you see that the City should be planning for and trying to meet?
- What do you see as the biggest safety issue in the City of Umatilla?
- Freight concerns or challenges?

OPPORTUNITIES

- What are some areas in the Umatilla roadways network that you think function well? (*Interviewer guidance: access, safety, congestion, etc. – ask for specific examples*)
- Where are opportunities for more efficient corridors? Suggested improvements?

WRAP UP:

- Anything else you want to be sure are considered in the master plan?
- Specific studies or documents that would be useful for the study team to review?
- Is there anybody else in your organization we should talk to about the Umatilla Transportation System Plan?

Interviewees

- Oregon Department of Transportation (ODOT)
Teresa Penninger, Region 5 Planning Manager
- School District | Clara Brownell Middle School
Rick Cotterell, Administrator | Principal
- Port of Umatilla
Kim Puzey, Executive Director
- Fire Department
Craig Bensen, Senior Fire Fighter and EMT
- Police Department
Darla Huxel, Police Chief
- 3-Rivers Prison
Justin Stark, Plant Manager
- United Grain Company
Jason Middleton, PNW Regional Manager

Umatilla Transportation System Plan
Technical Advisory Committee Meeting #1
June 9, 2022 10:00 AM

AGENDA

1. Introductions
2. Process for Plan Preparation
3. Existing Conditions Overview
 - Roadway Network and Functional Classification
 - Collision History
 - Pavement Conditions
 - Traffic Volumes and Capacity Analysis
4. Review transportation issues identified through stakeholder interviews
5. General transportation planning discussion for Umatilla
 - Multi-modal perspective
 - Future Roadway Network Needs and Functional Classification
 - Access management
 - Forecasting Future Traffic Volumes and Capacity Analysis
6. Public Open House
7. Next Steps

Umatilla Transportation Plan

Functional Classifications

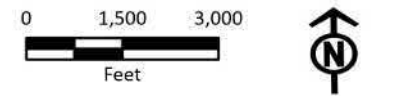
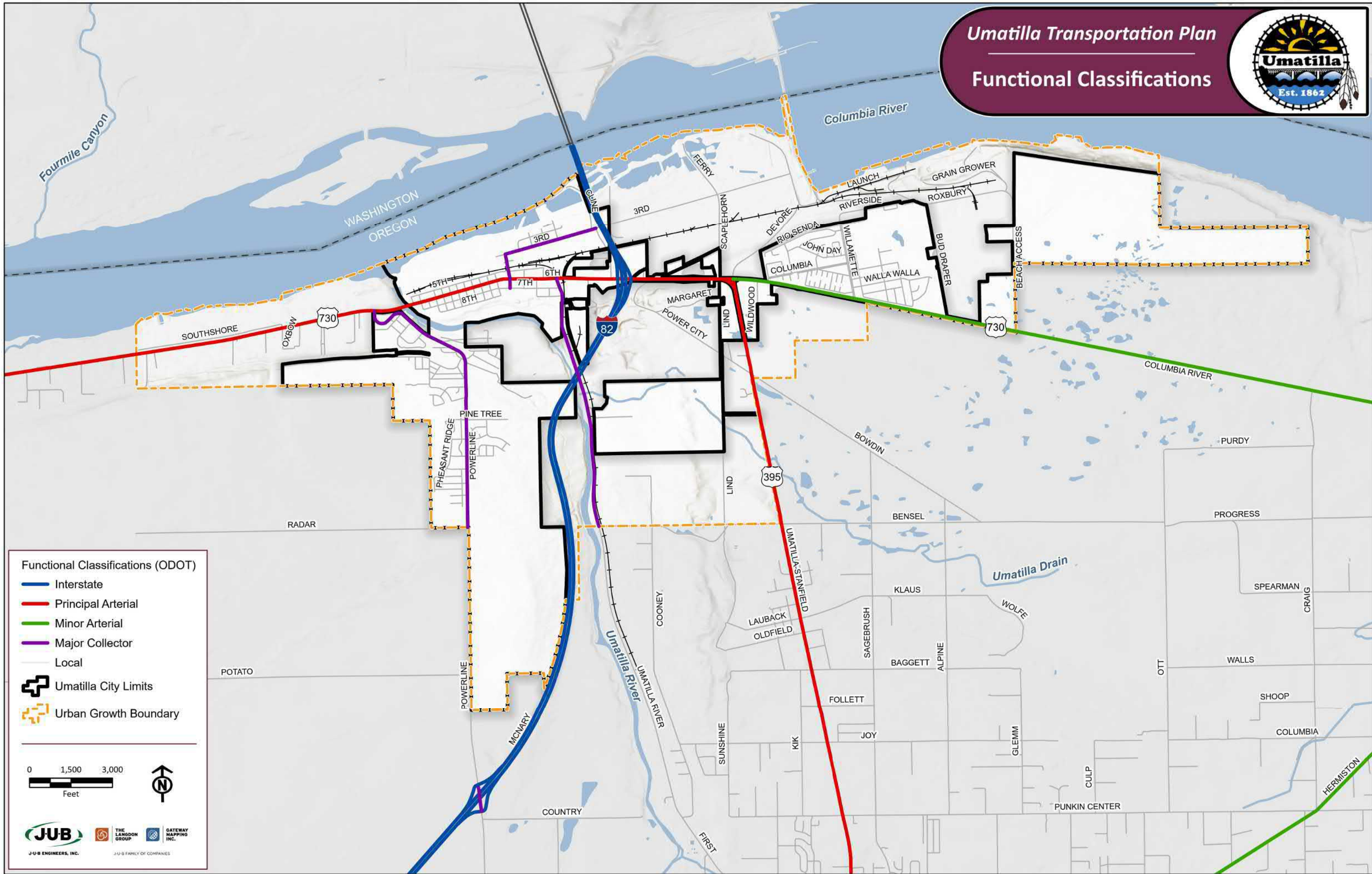

Umatilla Transportation Plan

Existing Conditions

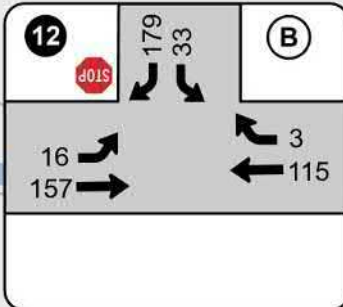
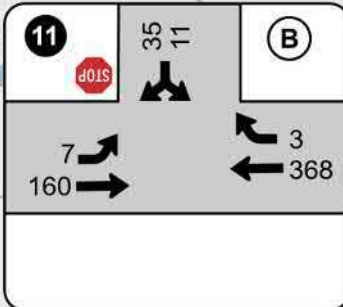
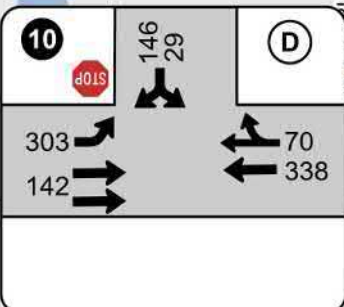
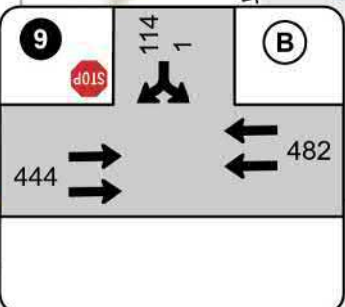
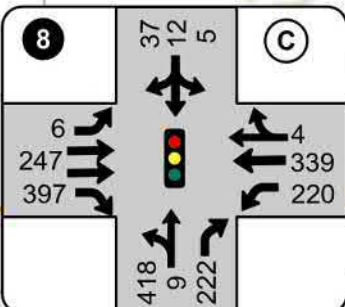
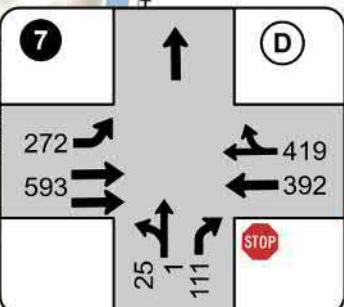
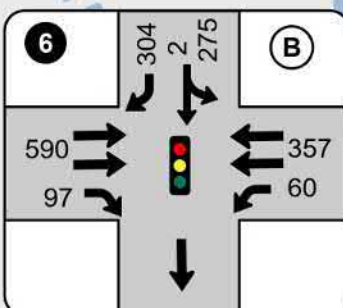
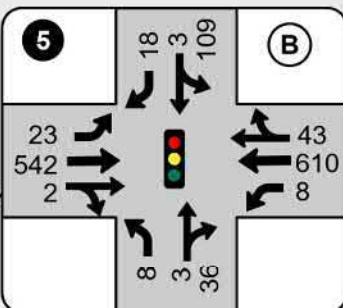
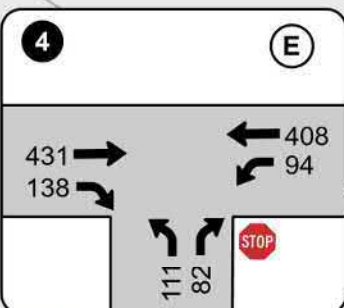
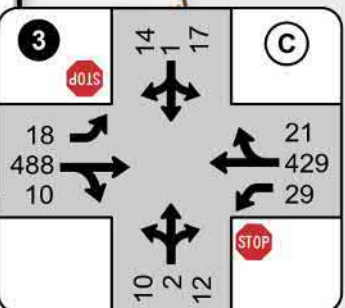
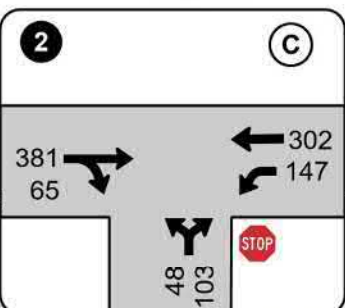
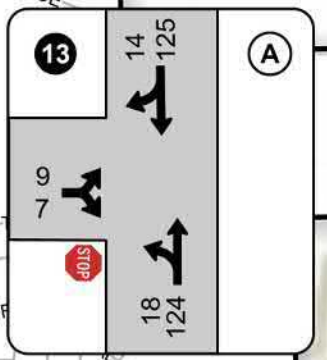
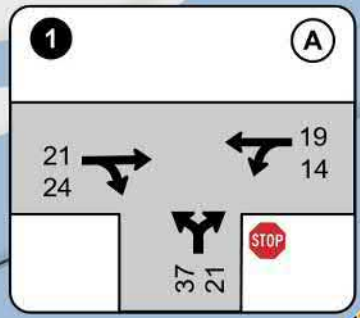
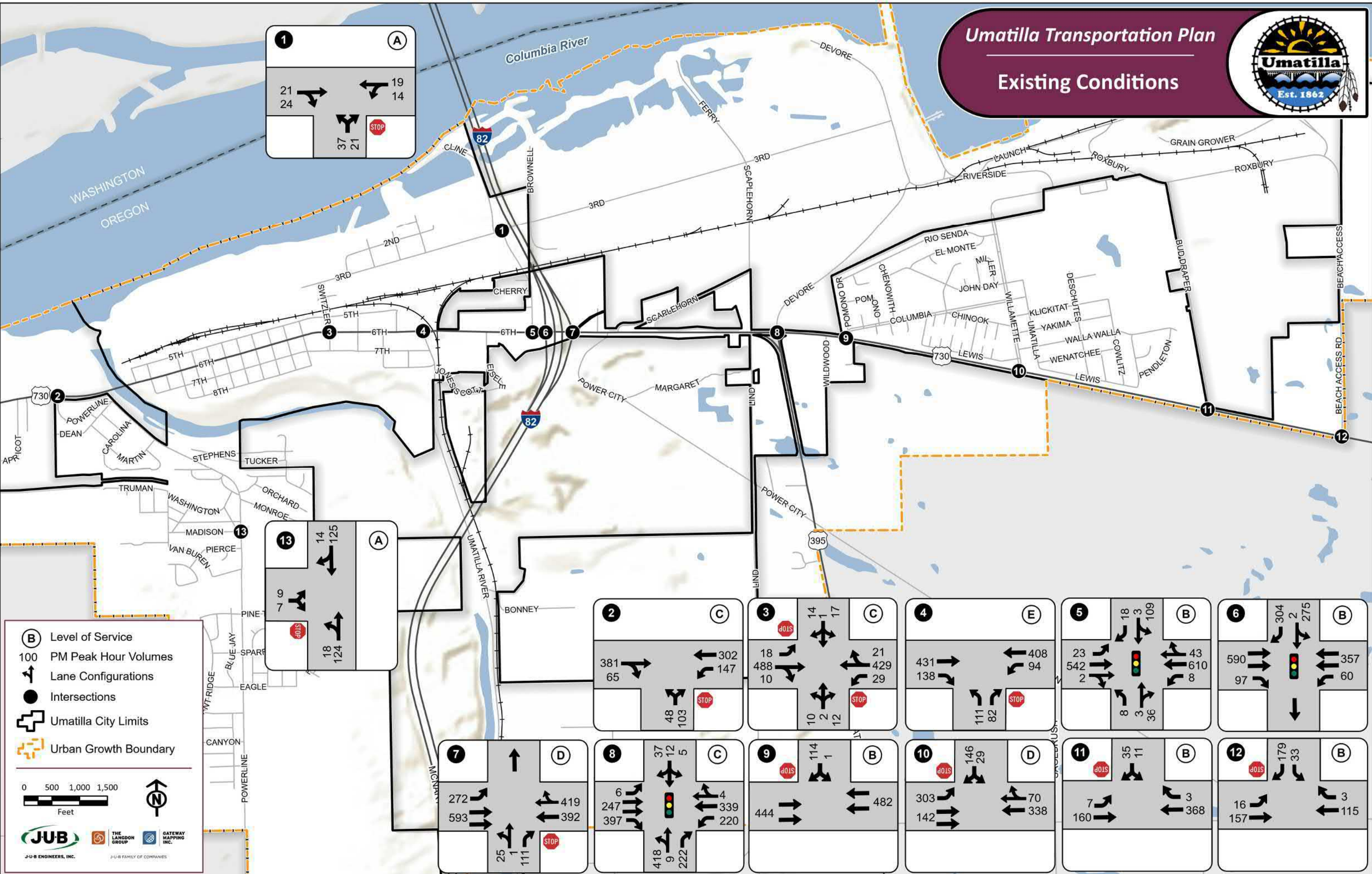
(B) Level of Service

100 PM Peak Hour Volumes

↔ Lane Configurations

● Intersections

⊕ Umatilla City Limits

⊞ Urban Growth Boundary

0 500 1,000 1,500 Feet

JUB J-U-B ENGINEERS, INC.



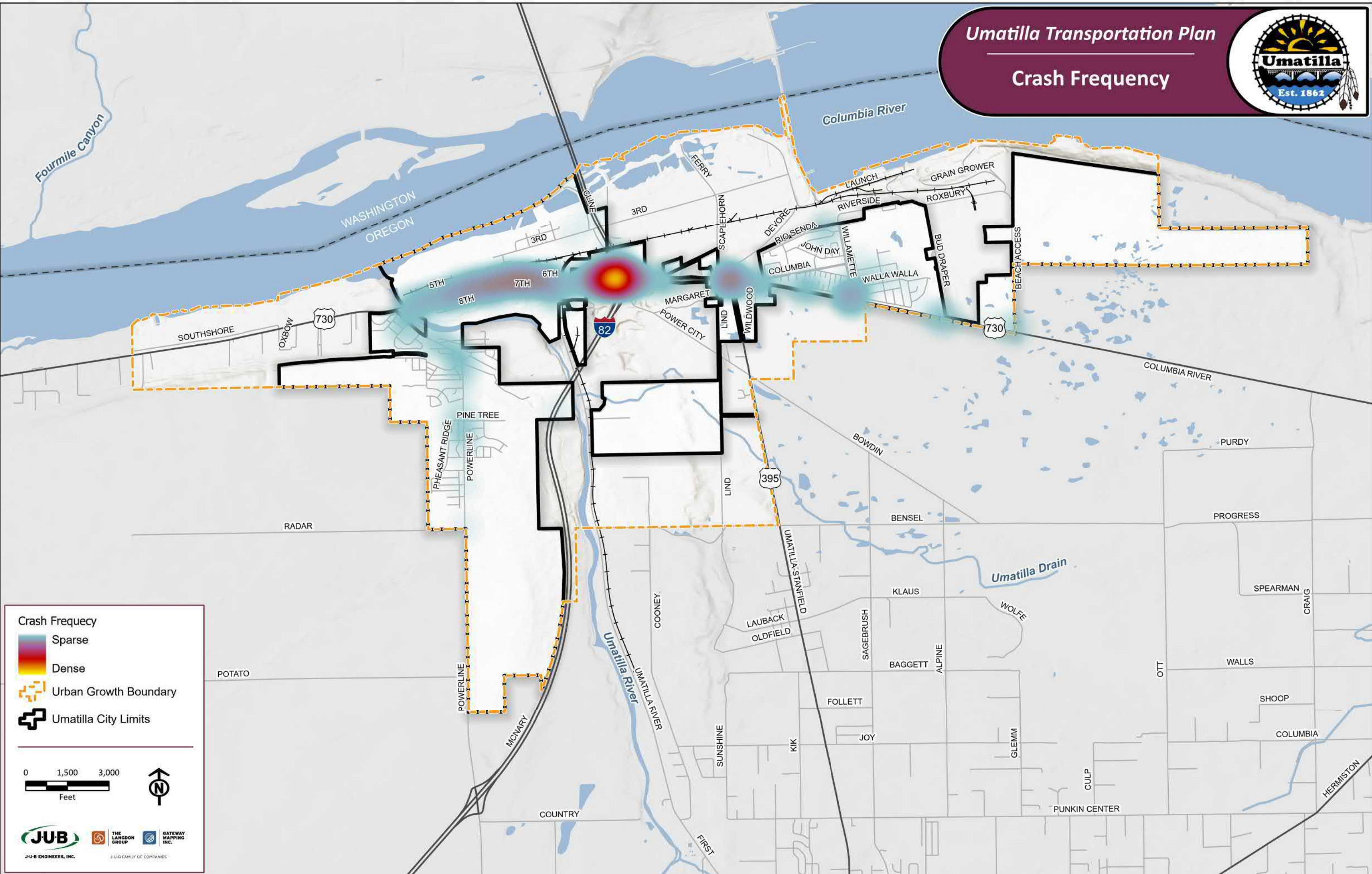

THE LANGDON GROUP

GATEWAY MAPPING INC.

J-U-B FAMILY OF COMPANIES



Crash Frequency

-  Sparse
-  Dense
-  Urban Growth Boundary
-  Umatilla City Limits

0 1,500 3,000
 Feet



JUB THE LANGDON GROUP GATEWAY MAPPING INC.
 J-U-B ENGINEERS, INC. J-U-R FAMILY OF COMPANIES

Umatilla Transportation Plan

Crash Severity (2015 - 2019)

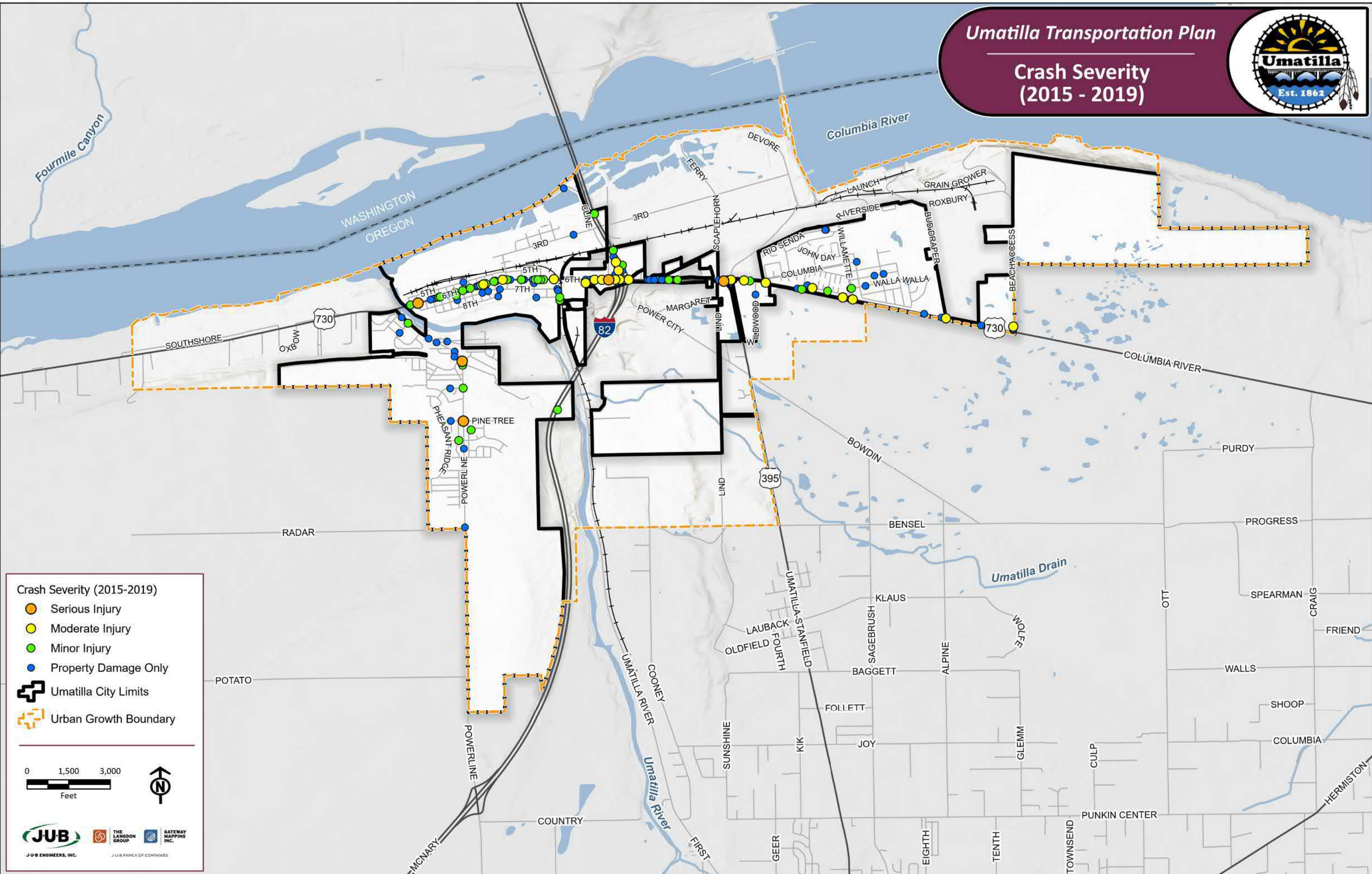
Crash Severity (2015-2019)

- Serious Injury
- Moderate Injury
- Minor Injury
- Property Damage Only
- Umatilla City Limits
- Urban Growth Boundary

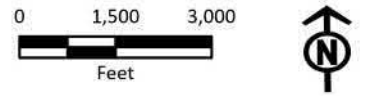

UMATILLA TRANSPORTATION SYSTEM PLAN
Collision History Summary (2015 - 2019)

Most Severe Injury Type	
Injury Type	# of Crashes
Suspected Serious Injury	5
Suspected Minor Injury	26
Possible Injury	73
No Apparent Injury	121
TOTAL	225

Most Common First Collision Type		
Collision Type	# of Crashes	
	Total	%
Animal	4	2%
Entering at angle	44	20%
Fixed Object	34	15%
Opposite direction, one straight one left turn	16	7%
Opposite direction - all others	7	3%
Same direction, both going straight	22	10%
Same direction, one stopped	57	25%
Same direction, one turn, one straight	4	2%
Same direction, all others	6	3%
Other object	3	1%
Overturned	5	2%
Other non-collision	2	1%
Parked Motor Vehicle	17	8%
Pedestrian	4	2%
TOTAL	225	100%

UMATILLA TRANSPORTATION SYSTEM PLAN
Collison History Summary (2015 - 2019)

Intersection	Incidents by Year						Most Severe Injury Type				
	2015	2016	2017	2018	2019	Total	Suspected Serious Injury	Suspected Minor Injury	Possible Injury	No Apparent Injury	Total
6TH ST & SB EX 6TH ST C1	4	6	4	2	7	23	0	5	7	11	23
6TH ST & BROWNELL BLVD	7	5	3	4	2	21	1	3	8	9	21
6TH ST & NB EF 6TH ST C2	5	3	3	5	2	18	0	1	5	12	18
COLUMBIA RIVER HY & UMATILLA-STANFLD HY	1	1	3	4	1	10	0	2	6	2	10
6TH ST & EISELE ST	1	2	2	2	2	9	0	2	0	7	9
COLUMBIA RIVER HY & WILLAMETTE AVE	0	2	3	2	1	8	0	2	3	3	8
MCNARY HY I-82 & NB EF 6TH ST C2/SB EX 6TH ST C1	3	1	1	2	1	8	0	2	3	3	8
6TH ST & SWITZLER AVE	3	2	0	1	1	7	0	1	3	3	7
6TH ST & YERXA AVE	2	2	0	3	0	7	0	0	4	3	7
COLUMBIA RIVER HY & COLUMBIA BLVD	0	2	1	2	1	6	0	2	1	3	6
COLUMBIA RIVER HY & BUD DRAPER RD	2	2	2	0	0	6	0	1	1	4	6
TOTAL	28	28	22	27	18	123	1	21	41	60	123

Intersection	Most Severe Injury Type												
	Animal	Entering at angle	Fixed Object	Opposite direction, straight and left turn	Opposite direction - all others	Same direction, both going straight	Same direction, one stopped	Same direction, one turn, one straight	Same direction, all others	Other object	Overtuned	Pedestrian	Total
6TH ST & SB EX 6TH ST C1	0	0	2	2	0	3	10	1	5	0	0	0	23
6TH ST & BROWNELL BLVD	0	5	1	0	1	2	9	3	0	0	0	0	21
6TH ST & NB EF 6TH ST C2	0	10	2	1	1	1	3	0	0	0	0	0	18
COLUMBIA RIVER HY & UMATILLA-STANFLD HY	0	2	1	3	0	0	4	0	0	0	0	0	10
6TH ST & EISELE ST	0	2	2	2	0	2	1	0	0	0	0	0	9
COLUMBIA RIVER HY & WILLAMETTE AVE	0	1	1	3	0	0	2	0	0	0	1	0	8
MCNARY HY I-82 & NB EF 6TH ST C2/SB EX 6TH ST C1	0	0	4	0	0	2	1	0	0	1	0	0	8
6TH ST & SWITZLER AVE	0	1	2	0	0	0	3	0	0	0	0	1	7
6TH ST & YERXA AVE	0	3	0	0	0	2	2	0	0	0	0	0	7
COLUMBIA RIVER HY & COLUMBIA BLVD	0	3	1	0	0	2	0	0	0	0	0	0	6
COLUMBIA RIVER HY & BUD DRAPER RD	2	0	2	1	0	0	0	0	0	1	0	0	6
TOTAL	2	27	18	12	2	14	35	4	5	2	1	1	123

Umatilla Transportation System Plan Update Public Involvement - Stakeholder Assessment

Overview

In April through June of 2022, The Langdon Group, a subsidiary of JUB Engineers specializing in public involvement and facilitation, conducted a series of stakeholder interviews for the Umatilla Transportation System Plan Update project. The goal of these interviews was to consult and collect direct feedback from local experts and prominent community members on the challenges and opportunities of Umatilla roadways. Stakeholders were identified in collaboration with the City and selected based on their ability to provide a cross-section of insight and expertise. In total, 8 interviews were conducted via Zoom and/or by phone based on the stakeholder's preference.

Overall, stakeholders felt that Umatilla roadways function well and meet the needs of their organizations and employees. All stakeholders commented that residential and commercial growth is of significant consideration for the area now and in the future. The majority of stakeholders identified the corridor of 730 (and its major intersections) as being the most important for safety and traffic flow improvements. The Downtown, South Hill and McNary neighborhoods were also commonly discussed as areas for priority consideration.

Additional feedback from the interviews centered around several main themes, including local growth, freight traffic, support for the current state of roadways and infrastructure, safety, priority issues and improvements, opportunities and long-term improvements, and miscellaneous items. Each of these are broken into detail below:

Expected Local Growth

- The fire department and police departments will likely expand.
- The Prison is unlikely to expand.
- The school district owns property on South Hill and is likely to build a new site there.
- Residential and economic growth are occurring, increased traffic and roadway impacts are expected.
- New data centers are expected at the current Amazon location and on South Hill.
- Expansion/widening of roads in the future will be difficult due to existing parallel electrical and pipeline infrastructure.

730 Corridor and Intersections

- Particularly at 730 and 82, current traffic flow is difficult at most times of the day. Most congested times of day are commuter hours between 6-7am, and 3:30-5pm.
- Current issues will be exacerbated by local residential and commercial growth
- Accidents occur frequently at the 730 and 82 interchange ramps.
- The absence of middle lanes and/or medians on 730 is frequently worrisome if not problematic.
- 730 to Beach Access Road is ok, with problems increasing moving west along the corridor.
- Visibility is poor with steep grade, and drivers exceed the speed limit.

Freight Traffic

- Volume of freight and semi traffic is high and increasing.
- The current location of the Port of Entry causes increased congestion and traffic flow issues.
 - Many supported relocation of the Port of Entry in order to separate freight and commuter traffic. (Potentially near rock quarry.)
- Increased freight traffic in McNary area; down Willamette Rd. Some confusion for freight trying to turn around in that area.
- High congestion on 395 causes loss of freight business. Trucks detour to side roads to avoid 395 and 84/82.
- The location and cumbersome process association with the weigh station is a deterrent for freight traffic and loses agricultural freight and economic growth for Oregon.
 - Consider a passport system to eliminate unnecessary and excessive fines.
- Freight traffic is the highest between July and August.
 - Minimize construction on Beach Access and Bud Draper Road during this time.
 - ODOT performs a gravel spray as a maintenance routine, which may impede or conflict with freight traffic during this time.
- Speeding is an issue, and greater enforcement for freight speed limits is needed.

Support for Current State of Roadways and Infrastructure

- Downtown Lighting is good, and important for pedestrian safety.
- Repaving of downtown corridor is good.
- The recently developed sidewalks and crosswalks are a welcome improvement and are used properly and frequently by pedestrians and children in downtown and accessing the high school.
- The schools are generally easy to access for emergency services.
- Improvements to Powerline corridor are appreciated and working well.
- Middle school parking lot is large enough and works well.
- General maintenance of roads and upkeep with growth is noted to be good, high quality.

Safety

- Powerline poses a threat to safety due to absence of sidewalks, mixed residential and industrial uses, narrow road, and lack of shoulder.
- Lighting around the 2-Rivers prison needs to be improved.
- Traffic control near Beach Access and Wanapuh Rd needs to be implemented to slow truck traffic and enforce adherence to reduced speed limit.
- Free range cattle is occasionally a safety issue <1 per year.
- River Road experiences casualties and safety issues due to limited visibility, sharp turns, and speeding.

Priority Issues and Improvements

- Reduce traffic in the downtown area.
 - Single lane traffic flow is problematic.
 - Slowing measures have worked some, but more may be needed included flashing pedestrian crosswalk signs.
- Find additional access to McNary neighborhood.

- Potentially East end of Bud Draper or connect to Devore on northwestern edge of the neighborhood.
- Major congestion occurs during school pick up and drop off times. Less students are walking or taking the bus, more individual car drop offs occur.
 - School district emergency planning for McNary is difficult due to limited access.
- Congestion in McNary is a common community complaint.
- Limited access to South Hill is worrisome for many:
 - Create a 2nd route to South Hill, potentially via Powerline and/or over the river.
 - Eliminate the “S” curve which connects Powerline to 730, north of South Hill as it slows down emergency response times.
 - Support for a foot bridge by South Hill and the high school
- Completing infrastructure (sidewalks, curbs, and gutter) for routes to and from schools.
- Improvements to Lind Road.
- The intersection of 6th and Columbia is a problematic one-way.
- The Port has no significant needs but supports prioritization of the needs of United Grain and Tidewater in the coming years.

Opportunities and long-term projects

- Expand parks and outdoor space near McNary.
- Beach Access Rd will be increasingly impacted with increase in industrial traffic.
 - Accidents were occurring on Beach Access with Amazon freight and employees from Two Rivers Correctional Institution.
- Improve bike-ped access from McNary to Downtown.
 - Take advantage of beautiful area by making a connection with a trails system.
- Areas in South Hill are unable to accommodate bus traffic for student pick up during ice events and cold months due to steep grade.
- Parking and transportation systems to support recreational and large community events.
- The City is in a good position, with a lot of funding opportunities, economic growth, and resources available.
- The intersection of 730 and 82 has potential to provide economic opportunity with design improvements, to attract business from through traffic, and represent Umatilla positively.

Miscellaneous

- Consider the various studies previously conducted and incorporate those findings. (Trail plans, studies to open Old Town for bike-ped use.)
- Hermiston is growing rapidly, may become a satellite community for the Tri-Cities. Collisions and safety concerns are increasing along 395 corridor south of Umatilla. A physical divider/median is needed.
- Have a plan for how to enforce improvements. Historically, the 82 interchange was intended to divert freight traffic from 395, however, without enforcement that intention was never fulfilled.
- The Port would like to work with the City to secure additional funds (grants, state, and federal funding, etc.)
- Retaining professionals for City planning and special studies will be key for quality long-lasting solutions.

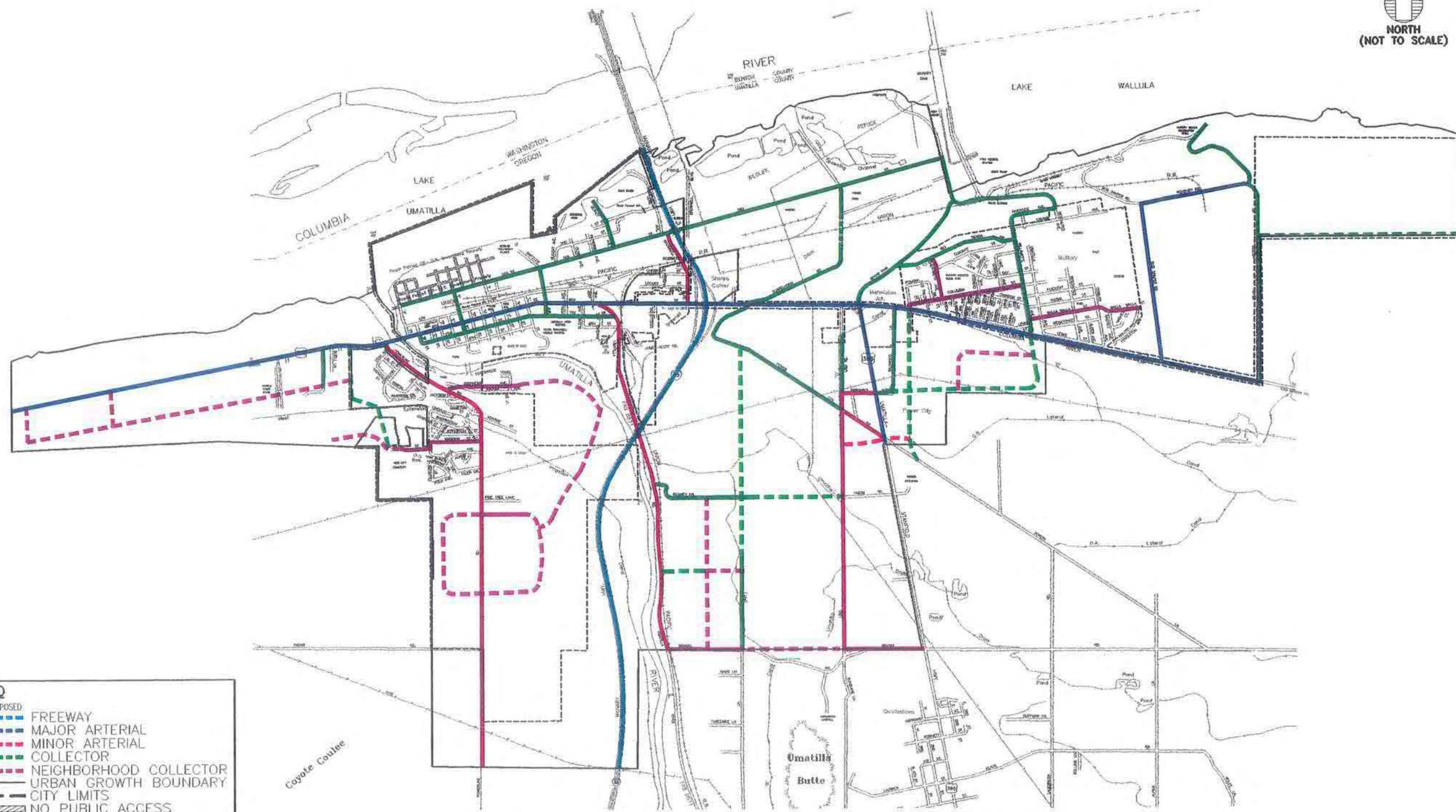

LEGEND		
EXISTING	PROPOSED	
		FREEWAY
		MAJOR ARTERIAL
		MINOR ARTERIAL
		COLLECTOR
		NEIGHBORHOOD COLLECTOR
		URBAN GROWTH BOUNDARY
		CITY LIMITS
		NO PUBLIC ACCESS

NOTE: PROPOSED ROADWAY ALIGNMENTS ARE CONCEPTUAL. FURTHER ENGINEERING IS REQUIRED TO DETERMINE FEASIBLE ALIGNMENT ALTERNATIVES.

ROADWAY NETWORK AND FUNCTIONAL CLASSIFICATION SYSTEM

CITY OF UMATILLA, OREGON
TRANSPORTATION SYSTEM PLAN
FEBRUARY 1999

FIGURE
12.2-11

**Umatilla Transportation System Plan Update
PM Peak Period Turning Movement Volumes - US 730 Corridor**

Powerline/6th (US 730)

	Northbound			Southbound			Eastbound			Westbound			Total Volume	
	Left	Thru	Right	Left	Thru	Right	Left	Thru	Right	Left	Thru	Right	15 minute	PHF
Existing PM Peak Hour	48	0	103	0	0	0	381	65	147	302	0	1046	0.94	
1997 Count	40	0	50	0	0	0	0	200	25	80	370	0	765	
% Increase to 2022	120%		206%				191%	260%	184%	82%			137%	

Switzler/6th (US 730)

	Northbound			Southbound			Eastbound			Westbound			Total Volume	
	Left	Thru	Right	Left	Thru	Right	Left	Thru	Right	Left	Thru	Right	15 minute	PHF
Existing PM Peak Hour	10	2	12	17	1	14	18	488	10	29	429	21	1051	0.92
1997 Count	5	5	20	20	5	15	10	335	5	10	500	15	945	
% Increase to 2022	200%	40%	60%	85%	20%	93%	180%	146%	200%	290%	86%	140%	111%	

Umatilla River Road (County Road 1275)/6th (US 730)

	Northbound			Southbound			Eastbound			Westbound			Total Volume	
	Left	Thru	Right	Left	Thru	Right	Left	Thru	Right	Left	Thru	Right	15 minute	PHF
Existing PM Peak Hour	111	0	82	0	0	0	0	431	138	94	408	0	1264	0.92
1997 Count	100	0	40	0	0	0	0	300	90	60	440	0	1030	
1997 % Increase to 2022	111%		205%					144%	153%	157%	93%		123%	
2009 Count (w/seasonal adj.)	160	0	75	0	0	0	0	320	145	75	470	0	1245	
2009 % Increase to 2022	144%		91%					74%	105%	80%	115%		98%	

Brownelle/6th (US 730)

	Northbound			Southbound			Eastbound			Westbound			Total Volume	
	Left	Thru	Right	Left	Thru	Right	Left	Thru	Right	Left	Thru	Right	15 minute	PHF
Existing PM Peak Hour	8	3	36	109	3	18	23	542	2	8	610	43	1405	0.94
1997 Count	5	5	15	65	10	45	20	395	5	15	580	30	1190	
1997 % Increase to 2022	160%	60%	240%	168%	30%	40%	115%	137%	40%	53%	105%	143%	118%	
2009 Count (w/seasonal adj.)	5	5	30	140	5	25	10	420	5	10	645	20	1320	
2009 % Increase to 2022	63%	167%	83%	128%	167%	139%	43%	77%	250%	125%	106%	47%	94%	

I-82 EB ramps (southbound)/6th (US 730)

	Northbound			Southbound			Eastbound			Westbound			Total Volume	
	Left	Thru	Right	Left	Thru	Right	Left	Thru	Right	Left	Thru	Right	15 minute	PHF
Existing PM Peak Hour	0	0	0	275	2	304	0	590	97	60	357	0	1685	0.94
1997 Count	0	0	0	180	5	225	0	420	55	25	400	0	1310	
1997 % Increase to 2022				153%	40%	135%		140%	176%	240%	89%		129%	
2009 Count (w/seasonal adj.)	0	0	0	265	5	295	0	440	150	40	380	0	1575	
2009 % Increase to 2022				96%	250%	97%		75%	155%	67%	106%		93%	

I-82 WB ramps (northbound)/6th (US 730)

	Northbound			Southbound			Eastbound			Westbound			Total Volume	
	Left	Thru	Right	Left	Thru	Right	Left	Thru	Right	Left	Thru	Right	15 minute	PHF
Existing PM Peak Hour	25	1	111	0	0	0	272	593	0	0	392	419	1813	0.93
1997 Count	20	5	55	0	0	0	120	480	0	0	405	150	1235	
1997 % Increase to 2022	125%	20%	202%				227%	124%			97%	279%	147%	
2009 Count (w/seasonal adj.)	35	5	55	0	0	0	160	545	0	0	385	285	1470	
2009 % Increase to 2022	140%	500%	50%				59%	92%			98%	68%	81%	

US 395/Devore Rd/6th St (US 730)

	Northbound			Southbound			Eastbound			Westbound			Total Volume	
	Left	Thru	Right	Left	Thru	Right	Left	Thru	Right	Left	Thru	Right	15 minute	PHF
Existing PM Peak Hour	418	9	222	5	12	37	6	247	397	220	339	4	1916	0.89
1997 Count	375	15	210	5	30	5	5	240	275	135	175	10	1480	
1997 % Increase to 2022	111%	60%	106%	100%	40%	740%	120%	103%	144%	163%	194%	40%	129%	
2009 Count (w/seasonal adj.)	370	5	165	5	20	25	5	260	330	130	260	5	1580	
2009 % Increase to 2022	89%	56%	74%	100%	167%	68%	83%	105%	83%	59%	77%	125%	82%	

Columbia/6th (US 730)

	Northbound			Southbound			Eastbound			Westbound			Total Volume	
	Left	Thru	Right	Left	Thru	Right	Left	Thru	Right	Left	Thru	Right	15 minute	PHF
Existing PM Peak Hour	0	0	0	1	0	114	0	444	0	0	482	0	1041	0.81
1997 Count	10	5	5	5	5	115	0	445	10	5	195	0	800	
1997 % Increase to 2022				20%		99%		100%			247%		130%	

Willamette/6th (US 730)

	Northbound			Southbound			Eastbound			Westbound			Total Volume	
	Left	Thru	Right	Left	Thru	Right	Left	Thru	Right	Left	Thru	Right	15 minute	PHF
Existing PM Peak Hour	0	0	0	29	0	146	303	142	0	0	338	70	1028	0.83
1997 Count	0	0	0	25	0	120	335	115	0	0	80	15	690	
1997 % Increase to 2022				116%		122%	90%	123%			423%	467%	149%	

Bud Draper/6th St (US 730)

	Northbound			Southbound			Eastbound			Westbound			Total Volume	
	Left	Thru	Right	Left	Thru	Right	Left	Thru	Right	Left	Thru	Right	15 minute	PHF
Existing PM Peak Hour	0	0	0	11	0	35	7	160	0	0	368	3	584	0.82
1997 Count	0	0	0	5	0	15	10	130	0	0	80	5	245	
1997 % Increase to 2022				220%		233%	70%	123%			460%	60%	238%	

Beach Access/ (US 730)

	Northbound			Southbound			Eastbound			Westbound			Total Volume	
	Left	Thru	Right	Left	Thru	Right	Left	Thru	Right	Left	Thru	Right	15 minute	PHF
Existing PM Peak Hour	0	0	0	33	0	179	16	157	0	0	115	3	503	0.79
1997 Count	0	0	0	5	0	5	10	130	0	0	80	5	235	
1997 % Increase to 2022				660%		3580%	160%	121%			144%	60%	214%	

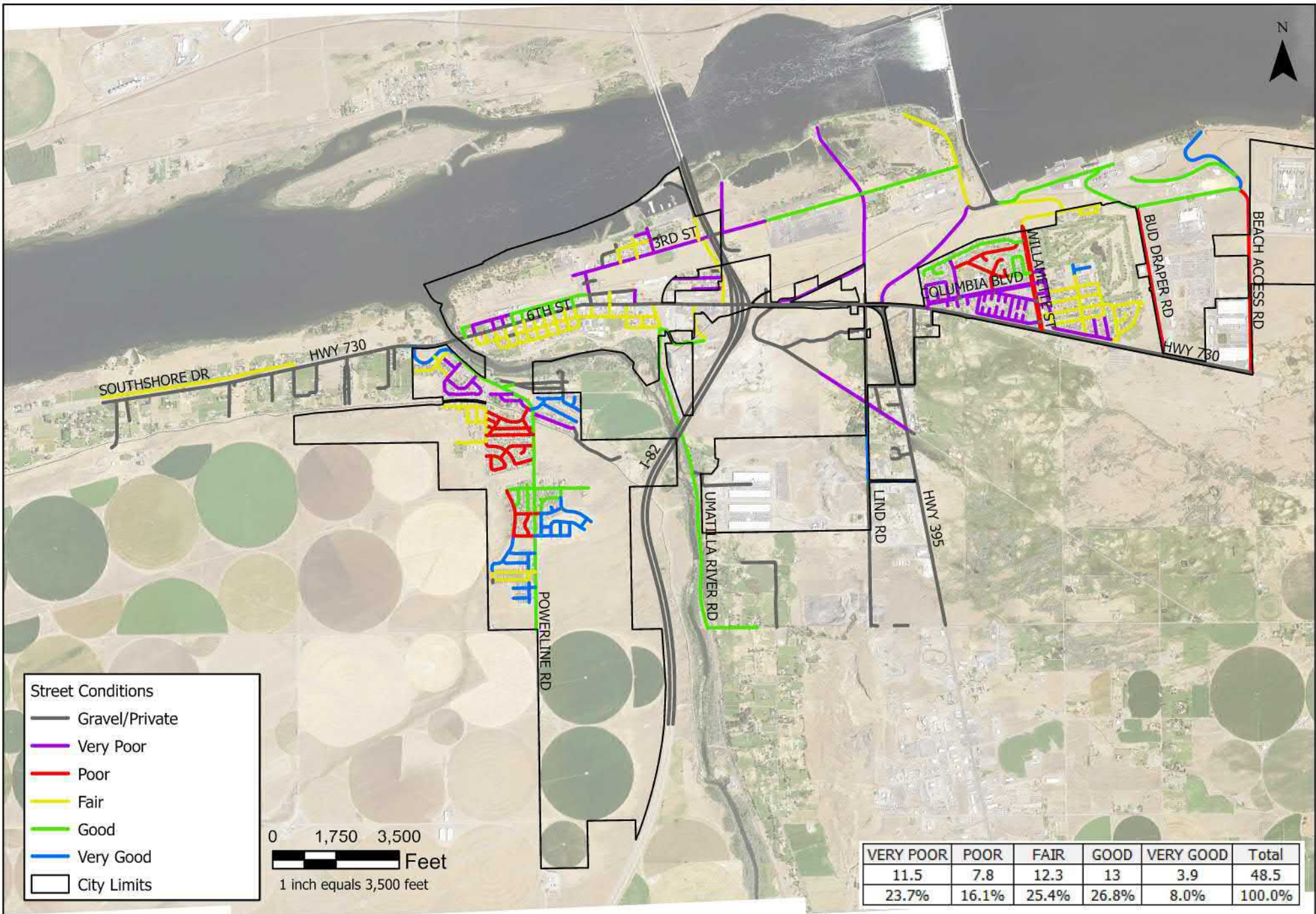

Street Conditions

- Gravel/Private
- Very Poor
- Poor
- Fair
- Good
- Very Good
- City Limits

0 1,750 3,500 Feet
 1 inch equals 3,500 feet

VERY POOR	POOR	FAIR	GOOD	VERY GOOD	Total
11.5	7.8	12.3	13	3.9	48.5
23.7%	16.1%	25.4%	26.8%	8.0%	100.0%



EXISTING PAVEMENT CONDITION INVENTORY (MAY 2022)

VICINITY
MAP

UMATILLA TRANSPORTATION
SYSTEM PLAN UPDATE
UMATILLA, OR

Umatilla Transportation System Plan
Open House Display Boards – Draft Overview

Board 1: Background

Board 2: What We've Heard from Stakeholders

Board 3: Existing Levels of Service

Board 4: Collision History

Board 5: Current Pavement Condition

Board 6: Public Participation Opportunities

- Comment sheet at public meeting
- Can use on-line form to drop a pin on a map with a comment
- Open House in the fall to comment on future conditions and alternatives analysis

Board 7: Timeline

[Line-graph showing what has been done, where we are now, next steps]

Have available copies of:

- Bicycle-Pedestrian Plan
- Other Studies??

Umatilla Transportation System Plan
Technical Advisory Committee Meeting #1
June 9, 2022 10:00 AM

MEETING SUMMARY

1. Introductions

Attendees:

- City of Umatilla – Brandon Seitz, Jacob Foutz, Scott Coleman, David Stockdale, Craig Bensen,
- J-U-B ENGINEERS, Inc. – Spencer Montgomery, Lisa Sefiken, Elizabeth Smith
- ODOT – Teresa Penninger
- Umatilla County – Carol Johnson, via Zoom
- Umatilla School District – Rick Cottrell

2. Process for Plan Preparation

- Anticipate public open house in the next few weeks. Team will identify locations for alternatives analysis with the City, depending on forecast congestion, safety issues identified by data and public input.
- After Alternatives analysis will have a TAC meeting towards the end of the summer, followed by public meeting, with plan completion this fall and adoption process.

3. Existing Conditions Overview

- Roadway Network and Functional Classification (see Functional Classification Figure)
 - Connector over Umatilla River to Punkin Center or Elm
 - Powerline a major collector moving forward
- Collision History (see Collision History Summary Tables and Figures)
 - Data was collected between 2015 and 2019 (5 years) with a total of 225 accidents reported.
 - 45% of these accidents consist of rear-ends (25%) and angled collisions (20%).
 - Zero fatalities, 5 accidents classified as “Suspected Serious Injury.”
 - 27% of all accidents occurred at or near the I-82 interchange. The most common was a rear-end collision (35%).
 - The City would like to see 2020 data at the I-82 interchange since the changes from ODOT.
 - Will hear from public about signal phasing on 730 going westbound at I-82 - City recommended to be adjusted with truck traffic because trucks wait too long at intersection, causing traffic backups.
 - Signal phasing on I-82 going south – City recommended flashing yellow for trucks.
- Pavement Conditions (see Pavement Condition History Figure)
 - Over 48 miles of city street were evaluated for pavement condition, with 35% being good or very good, 25% fair and 40 % being poor or very poor.
 - City provided comments on the pavement condition figure to be updated (Lind and Benzel).
- Traffic Volumes and Capacity Analysis (see Existing Conditions Figure)

- 13 intersections were reviewed for PM peak.
- Of the 13, one did not meet the Level of Service (LOS) standard – Umatilla River Rd @ HWY 730/6th St.
- Powerline @ HWY 730 is expected to fail LOS with upcoming development.
- City concerned with LOS on Powerline to the South.
- Additional freight traffic expected on John Scott due to an application for RNL Carriers expanding (short haul carrier)

4. Review transportation issues identified through stakeholder interviews

Issues Identified from Stakeholder Meeting:

- Weigh station
- Detour on 730
- 2nd Access to McNary Area
- Freight Traffic
- South Hill Access
- School Access

5. General transportation planning discussion for Umatilla

- Multi-modal perspective
 - Bike and Pedestrian plan was done in 2020 and recommended 11 projects.
 - Other opportunities – Pipeline (gas and diesel), marine, rail, and air.
- Future Roadway Network Needs and Functional Classification
 - Secondary access to Powerline and South Hill – Alternatives include:
 - Bridge over Umatilla River (10 year minimum) to connect to Punkin Center or Elm – will be important in document to recognize the need for cooperative effort with County and Hermiston
 - Bridge over canal to the west of Powerline with access north to HWY 730, box culvert expected (preferred)
 - School by McClanahan has failing septic
 - McNary Neighborhood
 - Columbia – Add eastbound left turn lane for additional access to McNary.
 - Bud Draper – Connection at Walla Walla St as a local street or at Riverside for truck traffic.
 - Riverside connection to Bud Draper or Toxbury
 - Detour Route off 730 (in order from most favorable to least favorable)
 - 3rd Street to B can give access all the way east to Brownell, improvements would be needed.
 - 5th Street does not exist from Switzler to Jane (as shown on Google Maps).
 - 7th Street doesn't have streetlights, is narrow, and through residential area, therefore is not good for detours.
 - Detour not needed for eastside of River Rd.
 - Safe Routes to School
 - 7th Street to Nugent to school
 - Switzler to School
 - Need a separated bike or pathway lane from McNary to High School, many walk that and have challenges with the I-82 interchange

- Weigh Station
 - 2 of 20 alternatives are feasible – 1) wishbone roundabout (potentially triple) and 2) close Brownell and direct truck traffic to exit.
 - Roundabouts were not looked at during the ODOT Study due to a moratorium that is no longer in effect.
 - Joint weigh station between WA and OR is not an option.
- Access management
 - Revisit access standards and what roads should be limited access
 - Powerline – No access or driveways
 - Major Arterial – Turn to No access in standards
 - Bud Draper – No private driveways
- Transit
 - Bus Stop Shelters are in the budget for next year. These are for routes that provide service by Kayak from Hermiston.
 - The City is looking into expanding Kayaks service into Umatilla.
 - New Transitional Housing (development starting 2022) will have a designated stop near the intersection of Benzel and Lind.
 - Potential Stop Locations on Powerline, Willamette, and Columbia (bulb out stops if road is redone).
- Forecasting Future Traffic Volumes and Capacity Analysis
 - Spreadsheet comparing traffic volumes from 1997, 2009 and 2022 was shared showing some challenges with the forecasting. A methodology will be shared and sent out through e-mail for comments.
 - During harvest in July/August there are 350 more trucks everyday on Bud Draper.
 - Good discussion on traffic patterns and that many are using different routes because there are more favorable turns, such as getting I-82 off northbound at Powerline and making a right turn onto US 730 into downtown, rather than a northbound left turn at the US 730 ramps.
 - Work at the Port of Entry may decrease trucks through technology
 - Powerline and Bridge – County Assessment Intersection Failed

6. Public Open House

- 11th or 12th of July is preferred date for city
- Reviewed list of materials that will be available for public review at open house
- Will circulate with TAC prior to open house.

7. Next Steps

Discussed that after the open house we will complete forecasting, evaluate future traffic volumes with existing roadway conditions, determine with the City locations/issues for alternatives analysis for capacity/safety/access, perform that alternatives analysis then call the TAC back together prior to an open house in the fall.



Welcome!

Thank you for attending the Umatilla Transportation System Plan Open House!

The Umatilla Transportation System Plan was originally adopted in 1999. Since then, additions to the plan have been made, but it has not been fully updated. This open house is part of the effort to update the plan to incorporate current and future needs.

Goals for Tonight:

- For the project team to present project information and answer questions
- Collect public comment on the transportation system and areas of concern





What We've Heard So Far

- Residential and commercial growth is occurring and will affect the roadways.
- The US 730 corridor (and its major intersections) needs to be carefully studied for safety and traffic flow improvements.
- Additional access to both South Hill and McNary neighborhoods is needed.
- Improved bicycle/pedestrian facilities from McNary to both downtown and the high school is needed.
- A detour route for US 730 is needed.
- Freight traffic is a significant factor in planning for Umatilla roadways.
- Overall, Umatilla roadways are in good condition, are maintained well, and meet the needs of citizens and businesses.



Existing Levels of Service

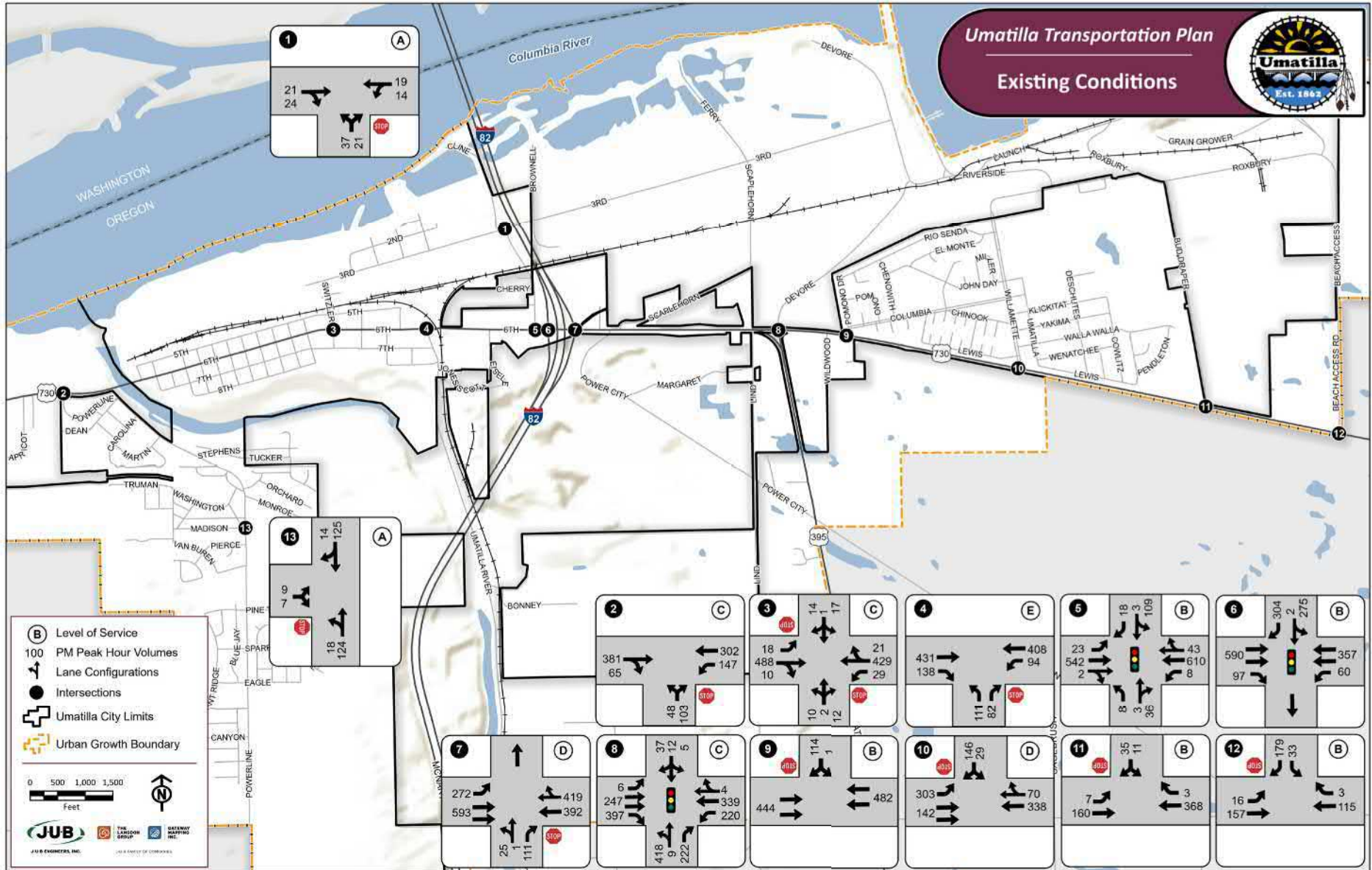

Collision History

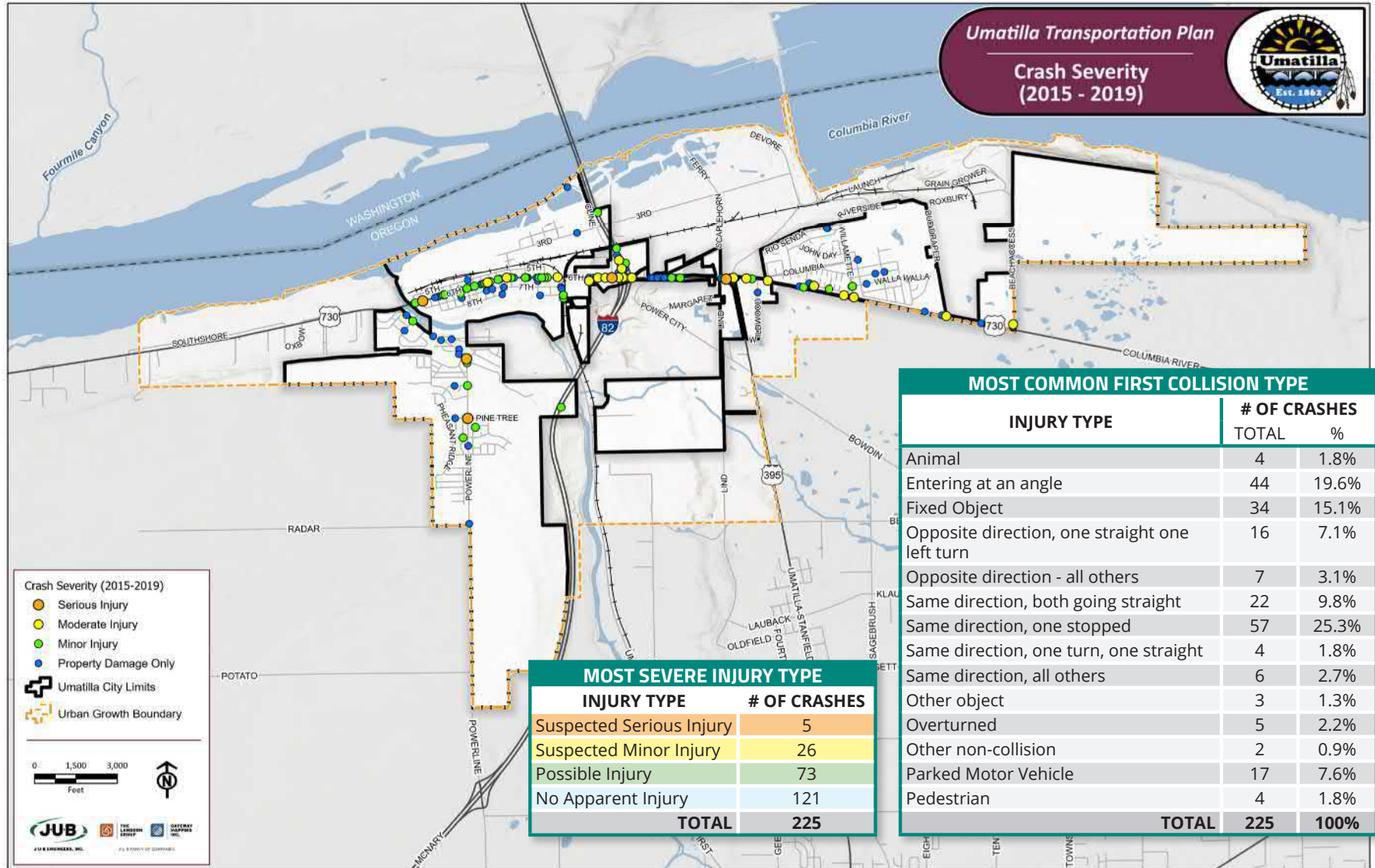

Umatilla Transportation Plan

Crash Severity (2015 - 2019)

MOST COMMON FIRST COLLISION TYPE		
INJURY TYPE	# OF CRASHES	
	TOTAL	%
Animal	4	1.8%
Entering at an angle	44	19.6%
Fixed Object	34	15.1%
Opposite direction, one straight one left turn	16	7.1%
Opposite direction - all others	7	3.1%
Same direction, both going straight	22	9.8%
Same direction, one stopped	57	25.3%
Same direction, one turn, one straight	4	1.8%
Same direction, all others	6	2.7%
Other object	3	1.3%
Overturned	5	2.2%
Other non-collision	2	0.9%
Parked Motor Vehicle	17	7.6%
Pedestrian	4	1.8%
TOTAL	225	100%

MOST SEVERE INJURY TYPE	
INJURY TYPE	# OF CRASHES
Suspected Serious Injury	5
Suspected Minor Injury	26
Possible Injury	73
No Apparent Injury	121
TOTAL	225

Current Pavement Condition

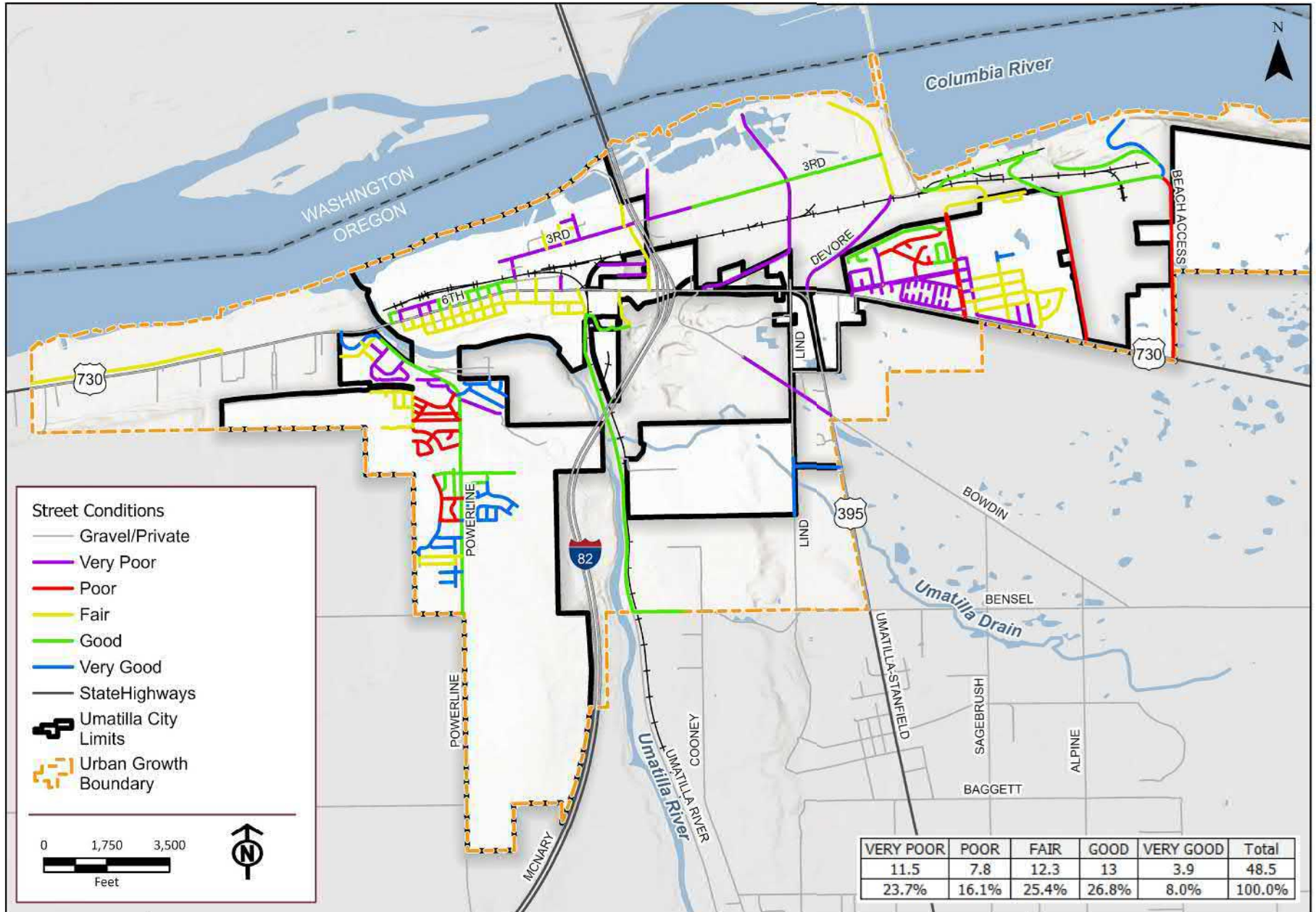

EXISTING PAVEMENT CONDITION INVENTORY (MAY 2022)

VICINITY
MAP

UMATILLA TRANSPORTATION
SYSTEM PLAN UPDATE
UMATILLA, OR



Public Involvement

Public involvement for this project includes:

- Stakeholder Interviews
- Public Surveying
- Technical Advisory Committee
- Open Houses (today and in early fall)

Tonight, your feedback will help the project team better understand how the residents and patrons of Umatilla use its roadways, areas of concern that should be evaluated, and how it can be improved to better serve you.

Please take a moment to fill out the comment card provided today, or make a comment online through an interactive map tool at

www.umatilla-city.org. Consider:



Scan to access survey

- Traffic Flow
- Intersections
- Traffic Signals
- Street Lighting
- Safety
- Pedestrian and Bike Access
- Sidewalks
- Condition of roadways

Umatilla Transportation System Plan Update



Timeline

Background

- **1999** - Original Transportation System Plan is adopted
- **2000** - US 395 North Corridor Plan adopted
- **2002** - Downtown Revitalization and Circulation Plan adopted
- **2007** - US 730 Corridor Refinement Plan
- **2011** - I-82/US 730 Interchange Area Management Plan completed
- **2020** - Bicycle and Pedestrian Plan adopted

WE ARE HERE

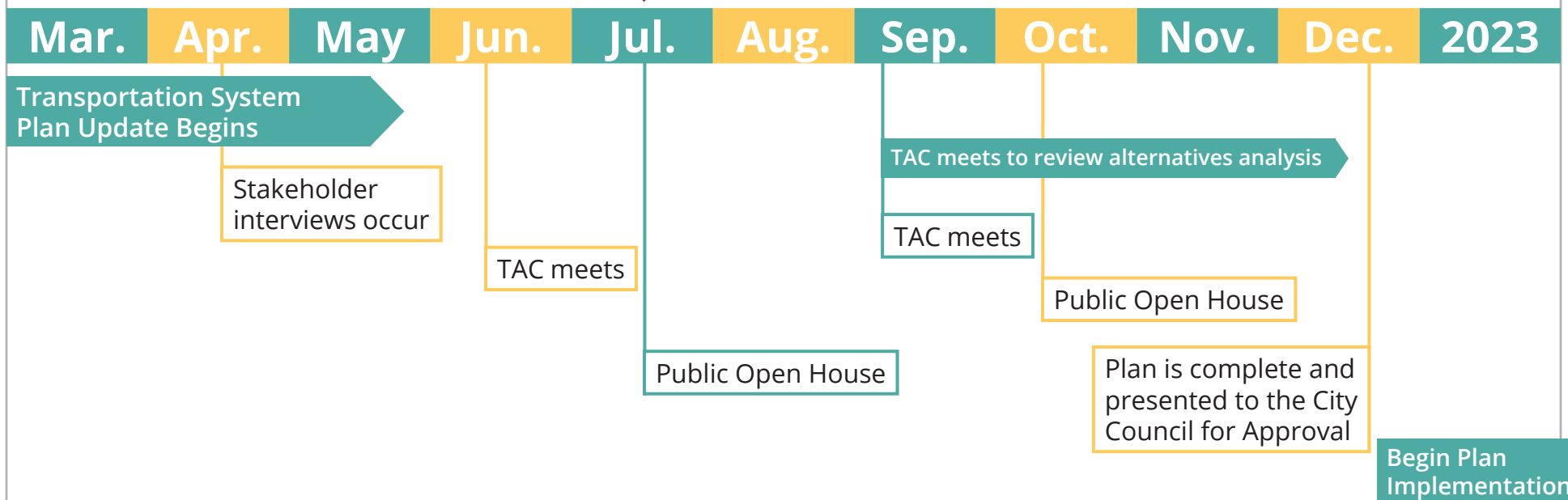

Umatilla Transportation System Plan Update



Umatilla Transportation System Plan Public Comments Received after July Open House

Map ID	Project Type	Comment
1	Roadway/ NetworkConnections	keep this access closed if you need access for fire life safety put in a gate
2	Safety	add a paved walk path ther are a lot of people that walk here with a narrow road
3	Roadway/ NetworkConnections	extend the road to Bud Draper Rd. allowing another way in and out of McNary to cut down on the traffic congestion due to the gas station that was added
4	Roadway/ NetworkConnections	open this back up allowing more access in and out of mcnary. There is too much traffic all trying to use the same space and people can't get in and out
5	Safety	Need green spaces and places for kids to play on Powerline
6	Safety	Sidewalks and improved shoulders for the safety of pedestrians!!!
7	TrafficCongestion	Long-range plans for this area MUST include an alternate access road for South Hill. There are now hundreds of residences here, with only one two-lane road for emergency vehicle access or evacuation purosos. This is a tragedy waiting to happen and must be addressed.
8	Safety	Trucks block traffic on Brownell every day. Can we fix the design somehow?
9	Safety	Add sidewalks on Powerline Road so pedestrians can safely walk downtown and to school.
10	Safety	I think you guys should add sidewalks along powerline. This would be helpful for all students that walk to school or for pedestrian's that enjoy going on walks.
11	TrafficCongestion	I second adding another way in and out of McNary via Walla Walla street. When a wreck happens at the entrance it creates a huge backup both ways.
12	Safety	Add another flashing light at the harvest food crosswalk. Lots of students cross here at lunchtime.
13	Safety	Add sidewalks
14	Safety	Fix potholes near fountain pond
15	Safety	The traffic on 730 can be heavy and at high speed making it difficult to turn onto or out of Willamette Ave. Could use a traffic light
16	Safety	Would like to see a bike/walking path along river road between Hermiston and Umatilla
17	BicyclePedestrian	Rebuild the foot bridge, so students walking to school have a safer route than the highway.
18	TrafficCongestion	Often get stuck waiting to turn left here.
19	BicyclePedestrian	Rebuild the foot bridge over the river
20	Safety	I agree. We need another way out of McNary
21	Safety	Definitely needs a traffic light.
22	BicyclePedestrian	School traffic light, like you have down town
23	TrafficCongestion	This area needs a traffic light.
24	TrafficCongestion	This area needs a traffic light.
25	Safety	In addition to bike/walking path, need paved shoulder and white lines on the side.
26	Safety	River Road needs wider paved shoulders, white side lines; along with walking/bike path.
27	Safety	Roundabout needed.
28	Safety	Roundabout needed.

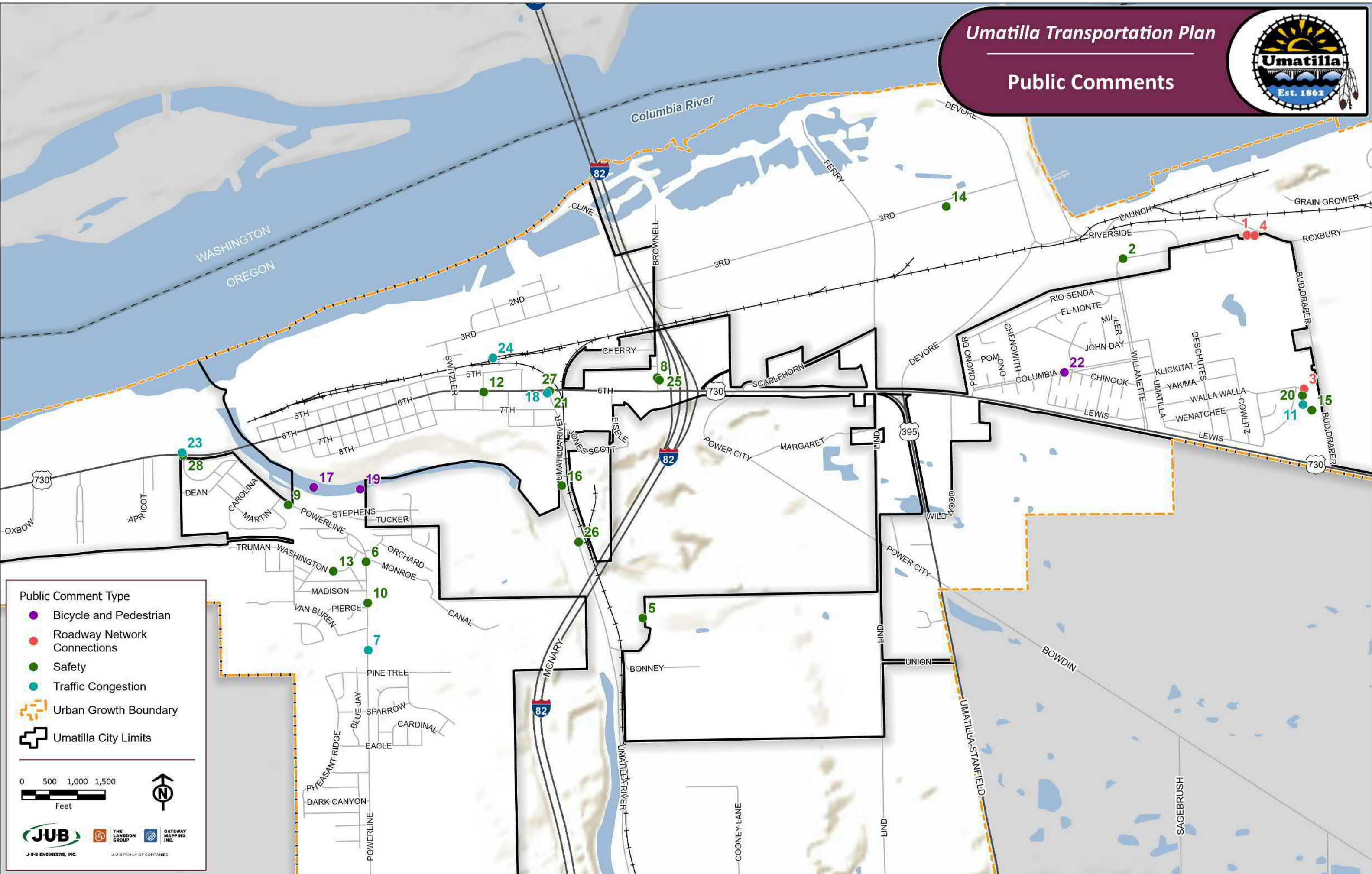

Public Comment Type

- Bicycle and Pedestrian
- Roadway Network Connections
- Safety
- Traffic Congestion
- Urban Growth Boundary
- Umatilla City Limits

0 500 1,000 1,500
 Feet



JUB THE LANGDON GROUP GATEWAY MAPPING INC.
 JUB ENGINEERS, INC. JUB FAMILY OF COMPANIES

Umatilla Transportation System Plan
Technical Advisory Committee Meeting #2
November 28, 2022 11:00 AM
(Via Teams video conferencing)

AGENDA

1. Introductions
2. Public Comments Received
3. Existing Conditions Overview
 - Update on Traffic Volumes and Seasonality
 - Capacity Analysis Results
4. Traffic Volumes Forecasting
 - Year 2043
 - Intermediate Year Forecasts, year of failure
5. Alternatives Analysis
 - Multi-modal perspective
 - Future Roadway Functionally Classified Network
6. Next Steps

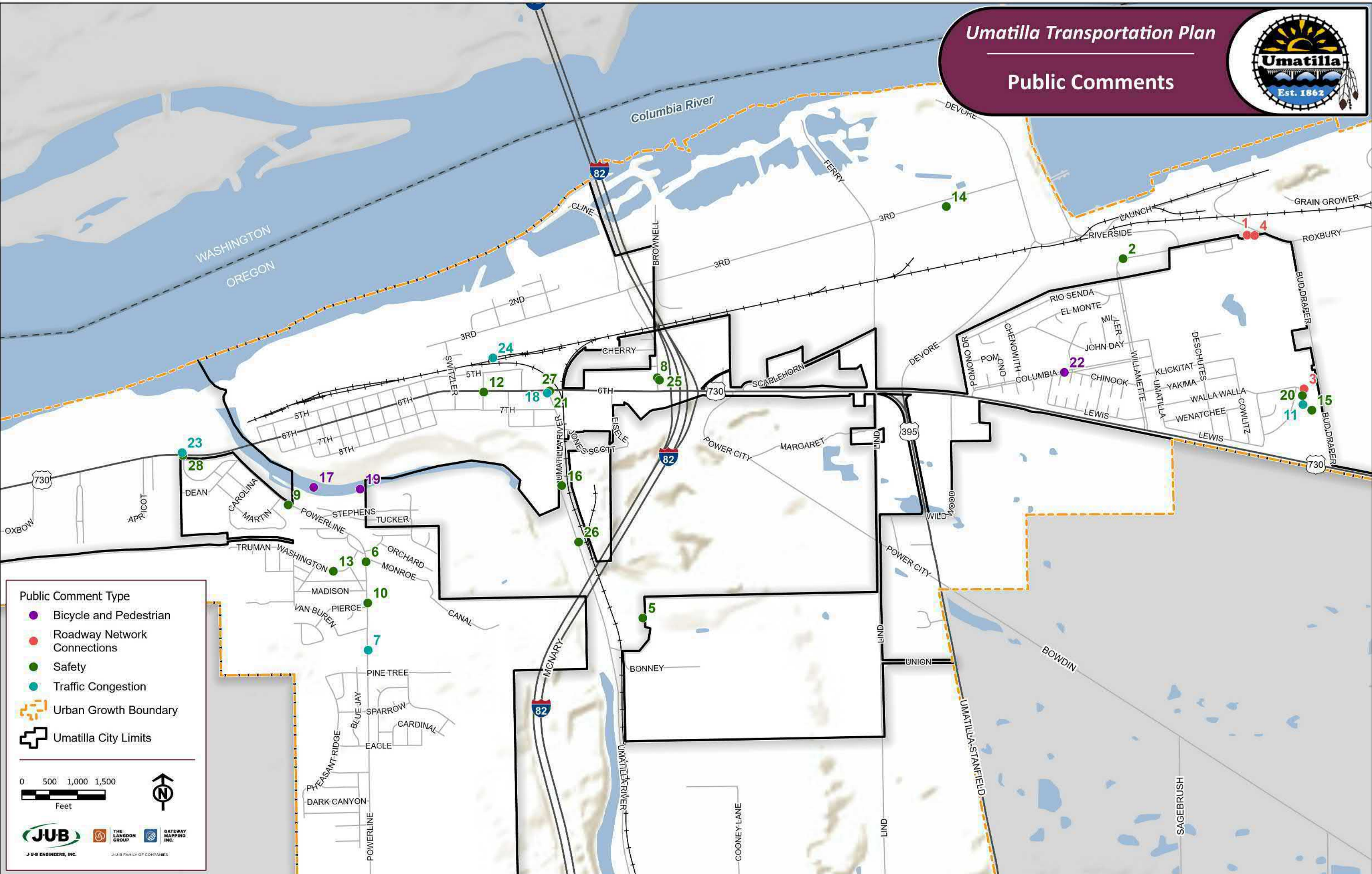

Public Comment Type

- Bicycle and Pedestrian
- Roadway Network Connections
- Safety
- Traffic Congestion
- Urban Growth Boundary
- Umatilla City Limits

0 500 1,000 1,500
 Feet



JUB THE LANGDON GROUP GATEWAY MAPPING INC.
 JUB ENGINEERS, INC. JUB FAMILY OF COMPANIES

Umatilla Transportation System Plan Public Comments Received after Open House

ID	Project Type	Comment
17	BicyclePedestrian	Rebuild the foot bridge, so students walking to school have a safer route than the highway.
19	BicyclePedestrian	Rebuild the foot bridge over the river
22	BicyclePedestrian	School traffic light, like you have down town
1	Roadway/ NetworkConnections	keep this access closed if you need access for fire life safety put in a gate
3	Roadway/ NetworkConnections	extend the road to Bud Draper Rd. allowing another way in and out of McNary to cut down on the traffic congestion due to the gas station that was added
4	Roadway/ NetworkConnections	open this back up allowing more access in and out of McNary. There is too much traffic all trying to use the same space and people can't get in and out
2	Safety	add a paved walk path ther are a lot of people that walk here with a narrow road
5	Safety	Need green spaces and places for kids to play on Powerline
6	Safety	Sidewalks and improved shoulders for the safety of pedestrians!!!
8	Safety	Trucks block traffic on Brownell every day. Can we fix the design somehow?
9	Safety	Add sidewalks on Powerline Road so pedestrians can safely walk downtown and to school.
10	Safety	I think you guys should add sidewalks along powerline. This would be helpful for all students that walk to school or for pedestrian's that enjoy going on walks.
12	Safety	Add another flashing light at the harvest food crosswalk. Lots of students cross here at lunchtime.
13	Safety	Add sidewalks
14	Safety	Fix potholes near fountain pond
15	Safety	The traffic on 730 can be heavy and at high speed making it difficult to turn onto or out of Willamette Ave. Could use a traffic light
16	Safety	Would like to see a bike/walking path along river road between Hermiston and Umatilla
20	Safety	I agree. We need another way out of McNary
21	Safety	Definitely needs a traffic light.
25	Safety	In addition to bike/walking path, need paved shoulder and white lines on the side.

26	Safety	River Road needs wider paved shoulders, white side lines; along with walking/bike path.
27	Safety	Roundabout needed.
28	Safety	Roundabout needed.
7	TrafficCongestion	Long-range plans for this area MUST include an alternate access road for South Hill. There are now hundreds of residences here, with only one two-lane road for emergency vehicle access or evacuation purposes. This is a tragedy waiting to happen and must be addressed.
11	TrafficCongestion	I second adding another way in and out of McNary via Walla Walla street. When a wreck happens at the entrance it creates a huge backup both ways.
18	TrafficCongestion	Often get stuck waiting to turn left here.
23	TrafficCongestion	This area needs a traffic light.
24	TrafficCongestion	This area needs a traffic light.

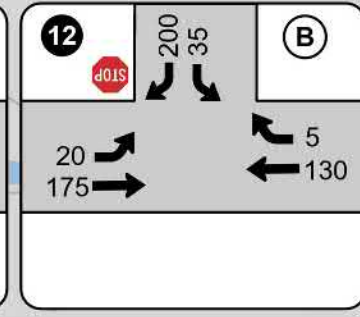
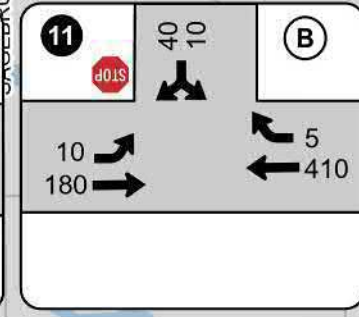
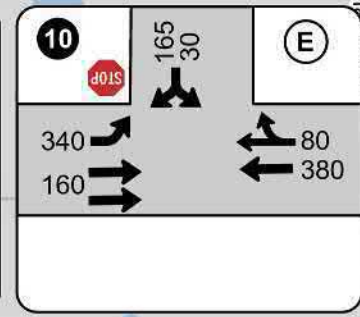
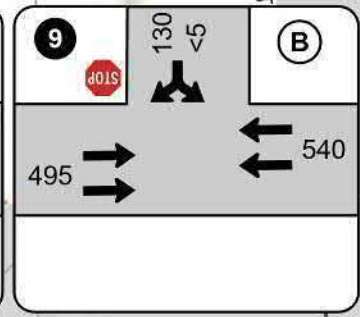
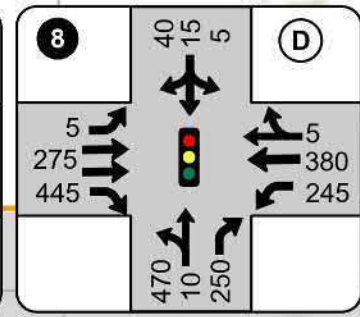
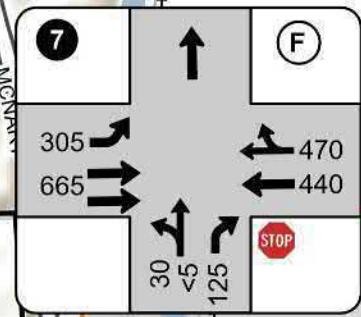
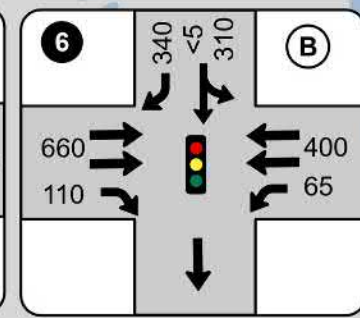
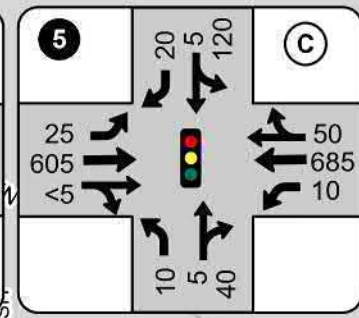
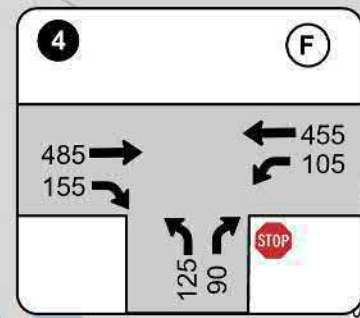
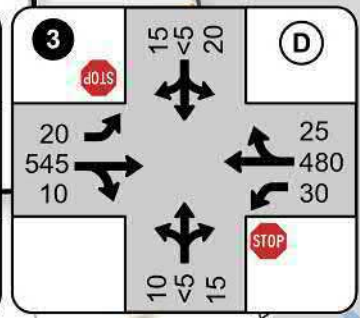
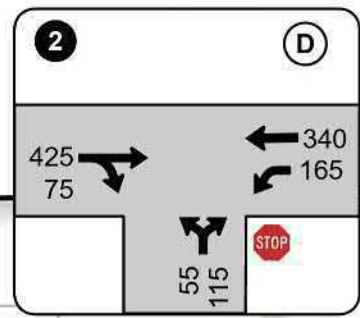
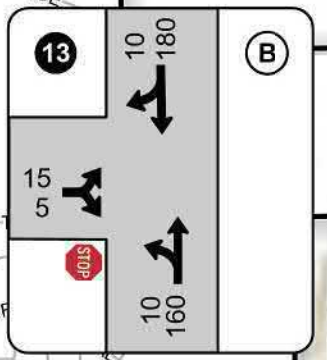
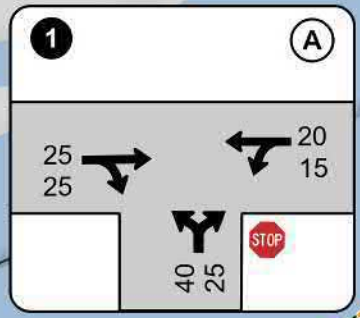
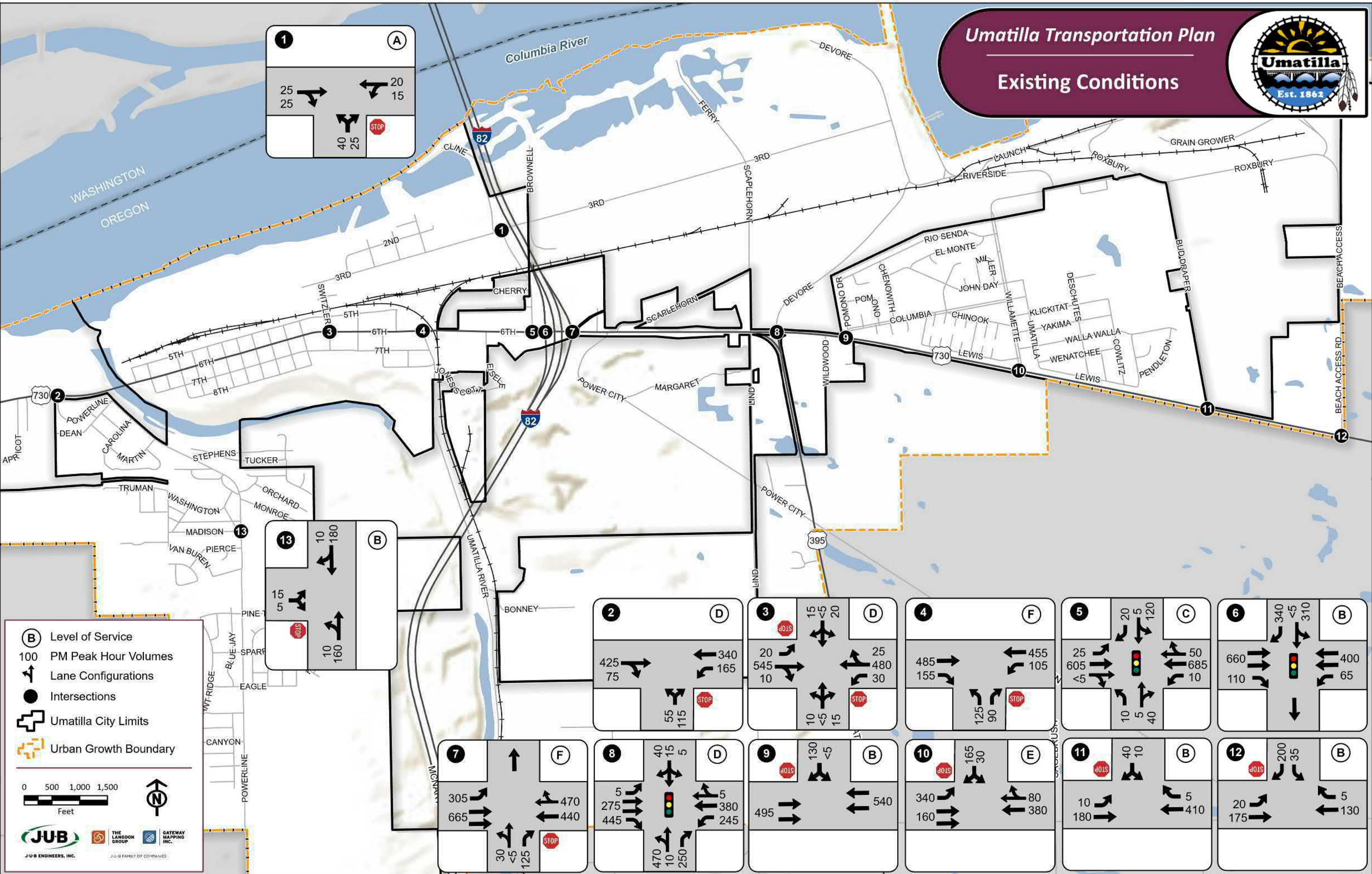

(B) Level of Service

100 PM Peak Hour Volumes

↔ Lane Configurations

● Intersections

⊕ Umatilla City Limits

⊞ Urban Growth Boundary

0 500 1,000 1,500 Feet

JUB J-U-B ENGINEERS, INC.

THE LANGDON GROUP

GATEWAY MAPPING INC.

Summary of 2022 PM Peak Hour Delay (sec) and Level of Service

Intersection	2022 PM Peak Hour						
	Overall Intersection			Worst Approach			
	Delay	LOS	V/C	Delay	LOS	V/C	Queue Lengths
1. Brownelle/Third	*			NB--9.3	A	0.09	
2. Powerline/6th	*			NB--20.5	C	0.44	
3. Switzler/6th	*			SB-- 29.0	D	0.23	
4. River Road/6th	*			NB--87.4	F	0.95	NB=215
5. Brownelle/6th	20.2	C	0.73	SB--25.0	C	0.47	
6. SB I-82 ramps/6th	17	C	0.73	WB--22.0	C	0.35	WBL = 86, WBT = 147, SB 260
7. NB I-82 ramps/6th	*			NB--214.3	F	2.13	NB=143, EBL 102
8. US 395/6th	53.1	D	0.68	NB--95.8	F	1.21	NBL=698+, WBL=220
9. Columbia/6th	*			SB--12.9	B	0.27	
10. Willamette/6th	*			SB--46.0	E	0.76	SB=148
11. Bud Draper/ 6th	*			SB--12.9	B	0.12	
12. Beach Access/6th	*			SB--10.9	B	0.29	
13. Powerline/Madison	*			EB--10.9	B	0.04	

LEGEND

60.8/E -- 0.05 Delay and Level of Service and V/C ratio using existing lane configurations

* Uncontrolled Movements (major street through) not provided for overall intersection Analysis for Two-way Stop Controlled Intersections

NB = northbound, SB = southbound, WB = westbound, EB = eastbound

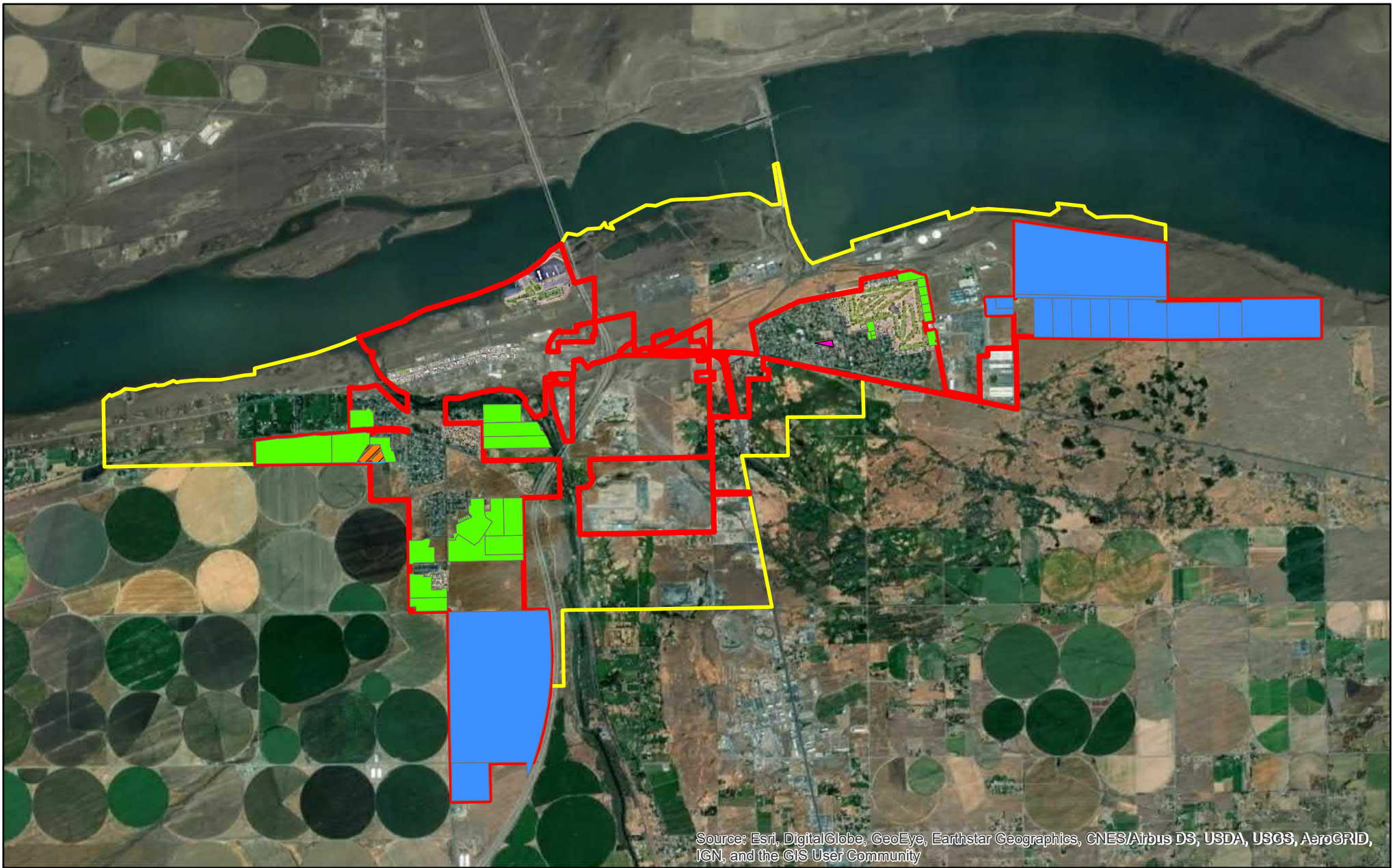





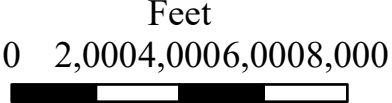

Source: Esri, DigitalGlobe, GeoEye, Earthstar Geographics, CNES/Airbus DS, USDA, USGS, AeroGRID, IGN, and the GIS User Community

ANTICIPATED DEVELOPMENT WITHIN CITY OF UMATILLA



Legend

- | | | | | | |
|--|-------------|---|------------|---|-----------------------|
|  | Residential |  | New School |  | City Limits |
|  | Industrial |  | Commercial |  | Urban Growth Boundary |

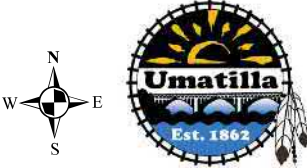

MAP DISCLAIMER: No warranty is made as to the accuracy, reliability or completeness of this data. Map should be used for reference purposes only. Not survey grade or for legal use. Created by Jacob Foutz, on 4/14/2022

Umatilla Transportation Plan

2043 Traffic Forecasts

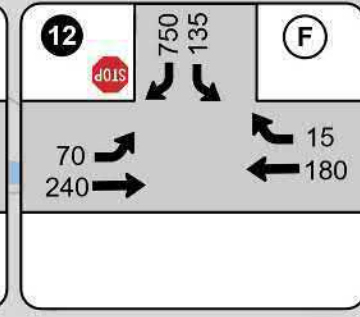
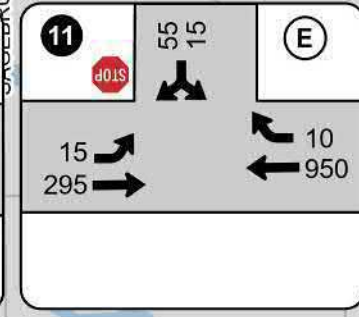
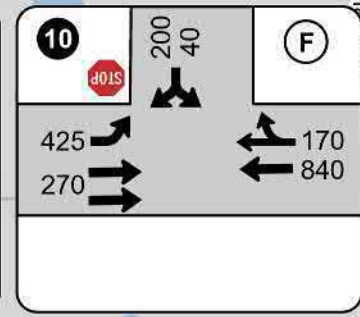
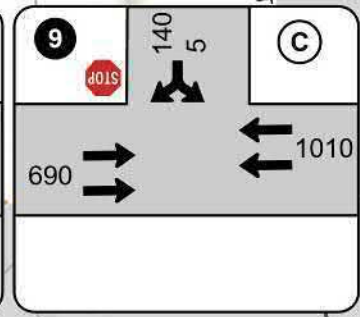
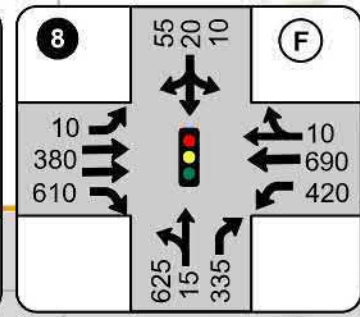
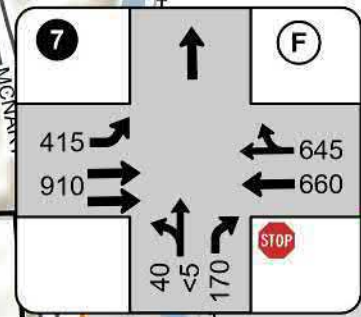
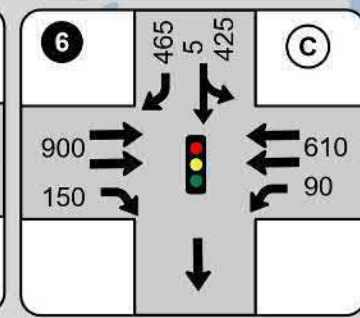
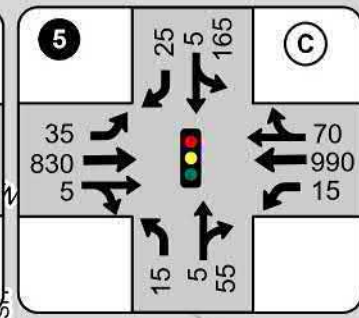
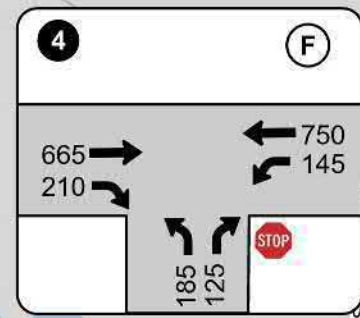
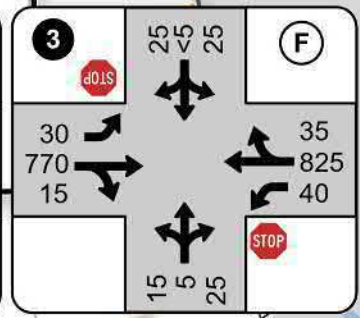
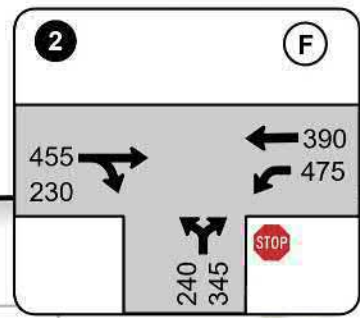
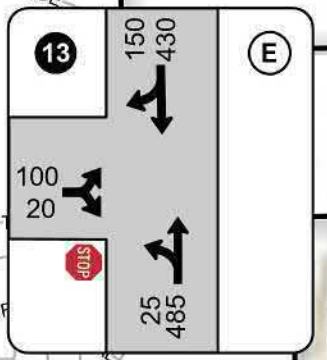
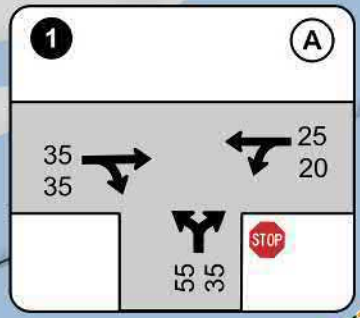
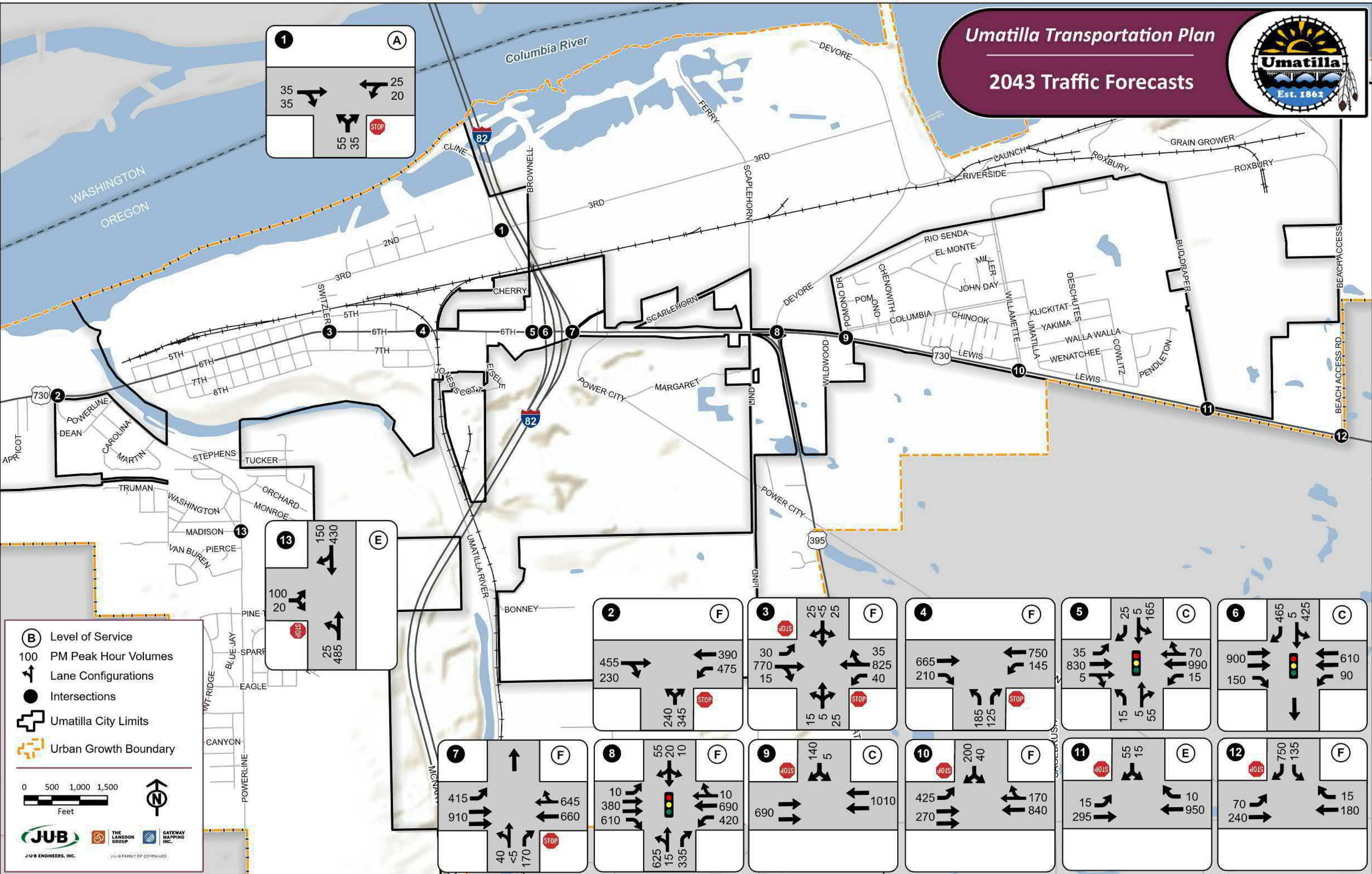
(B) Level of Service

100 PM Peak Hour Volumes

↔ Lane Configurations

● Intersections

⊕ Umatilla City Limits

⊞ Urban Growth Boundary

0 500 1,000 1,500 Feet

JUB J-U-B ENGINEERS, INC.

THE LANGDON GROUP

GATEWAY MAPPING INC.

Summary of 2043 No-Build PM Peak Hour Delay (sec) and Level of Service

Intersection	2043 PM Peak Hour							Year of Failure
	Overall Intersection			Worst Approach				
	Delay	LOS	V/C	Delay	LOS	V/C	Queue	
1. Brownelle/Third	*			NB--9.7	A	0.13		
2. Powerline/6th	*			NB--4717	F	11.18	NB=1868'	2028
3. Switzler/6th	*			SB-- 117.6	F	0.67	SB=78'	2028
4. River Road/6th	*			NB--1218	F	3.50	NB=845'	2022
5. Brownelle/6th	24.1	C	0.9	SB--38.0	D	0.68	WB=469'	
6. SB I-82 ramps/6th	26.7	C	0.9	SB--37.0	D	0.90	WBL = 140', WBT=200', SB 464'	
7. NB I-82 ramps/6th	*			NBL>999, EBL160	F	EBL 1.25	NB=143, EBL 548'	2022
8. US 395/6th	121.8	F	0.89	NB--142.6	F	1.38	NBL=1183+, WBL=771+, EBT=249'	2028
9. Columbia/6th	*			SB--23.1	C	0.48		
10. Willamette/6th	*			SB--7673	F	17.08	SB=925'	2022
11. Bud Draper/ 6th	*			SB--36.8	E	0.44	SB=50'	2038
12. Beach Access/6th	*			SB--97.3	F	1.17	SB=740'	2038
13. Powerline/Madison	*			EB--40.0	E	0.58	EB=80'	2043

LEGEND

60.8/E -- 0.05 Delay and Level of Service and V/C ratio using existing lane configurations

way Stop Controlled Intersections

NB = northbound, SB = southbound, WB = westbound, EB = eastbound

Umatilla Transportation Plan

Alternatives Analysis

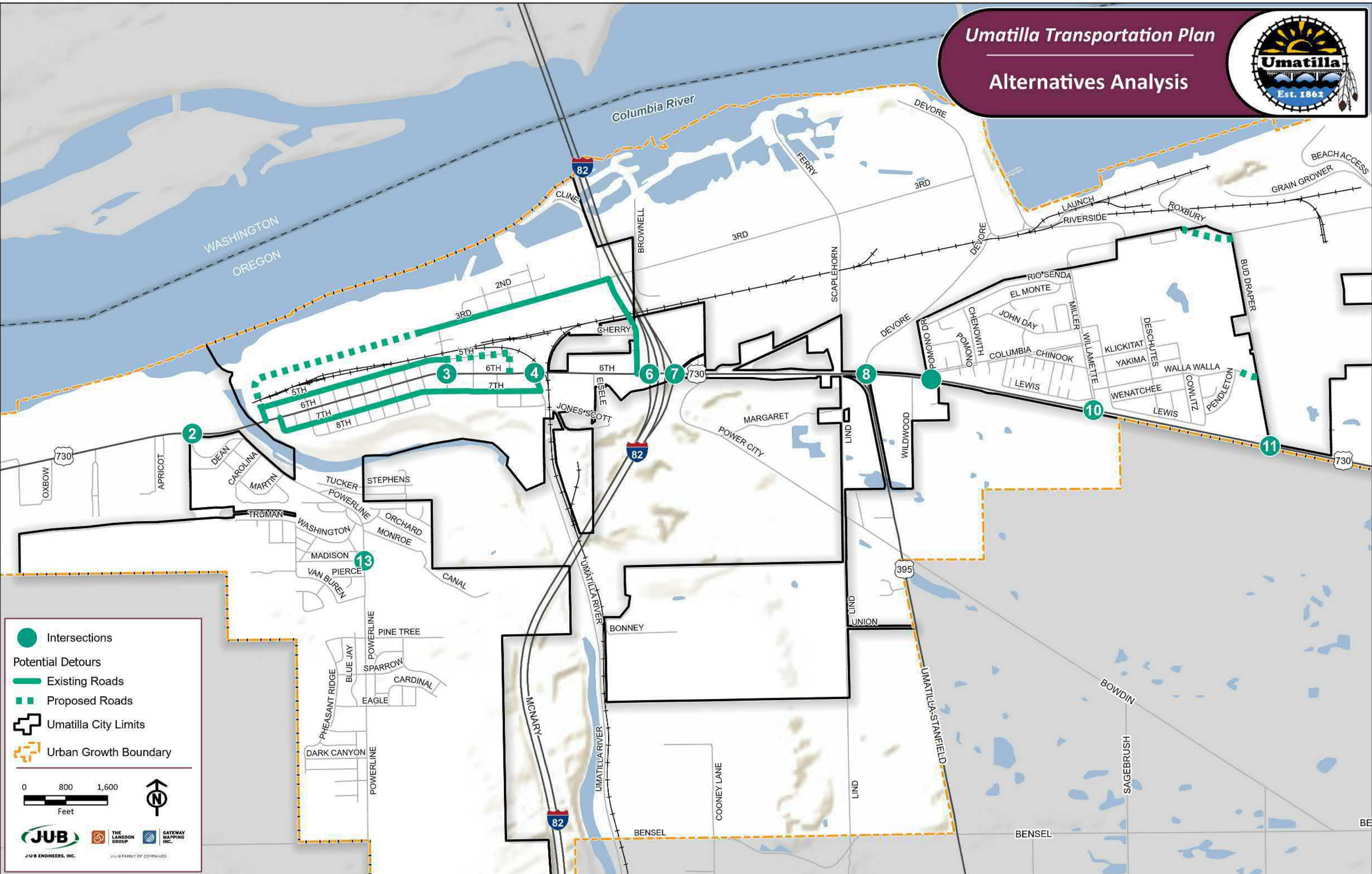

- Intersections
- Potential Detours**
- Existing Roads
- Proposed Roads
- Umatilla City Limits
- Urban Growth Boundary

0 800 1,600
Feet

JUB THE LANGDON GROUP GATEWAY MAPPING INC.
J-U-B ENGINEERS, INC. J-U-B FAMILY OF COMPANIES

**Umatilla Transportation Systems Plan
Potential Mitigation Alternatives for Analysis**

Intersection	Alternatives	Comments
2. Powerline/6th	Roundabout	Potential Interim Improvements: Add NBL, EBR, WB departure (mostly striping)
	Traffic Signal	
3. Switzler/6th	NBL, SBL	Not likely to fix this with turn lanes with the forecast volumes
	Restrict N/S Left Turns during peak hours	Unlikely to meet signal warrants
	Do Nothing (let people decide to go right and U-turn/Left turn)	
4. River Road/6th	Restripe for WB departure lane	Potential Interim Improvements: Add NBL, EBR, WB departure (mostly striping)
	roundabout	
	Traffic Signal	Roundabout has challenges with the overpass structure.
7. NB I-82 ramps/6th	Traffic Signal - 3 potential lane configurations	Queueing challenges
	Roundabout	Roundabout not ideal with significant left turn volume.
8. US 395/6th	Add 2nd NBL	Flyover included in earlier TSP Alternatives
	Add 2nd WBL	Roundabout not felt meaningful since both heavy movements use 3/4 of the roundabout
	Add both 2nd NBL and 2nd WBL	
10. Willamette/6th	Add SBL, EB departure lane	Not likely to fix this with turn lanes with the forecast volumes
	Roundabout	Unlikely to meet signal warrants.
11. Bud Draper/6th	Add SBL	Provides acceptable LOS
	Roundabout	May be meaningful to add 2nd westbound lane to Willamette
12. Beach Access/6th	Extend Storage for SBR, add WB departure lane to receive SBR	May be meaningful to add 2nd westbound lane to Willamette
	Roundabout	Unlikely to meet signal warrants
13. Powerline/Madison	Add EBL, SBR	Unlikely to meet signal warrants
	Roundabout	

Mitigation Alternative 1 at I-82/Northbound Ramps



Mitigation Alt 1 -- LOS and V/C ratios

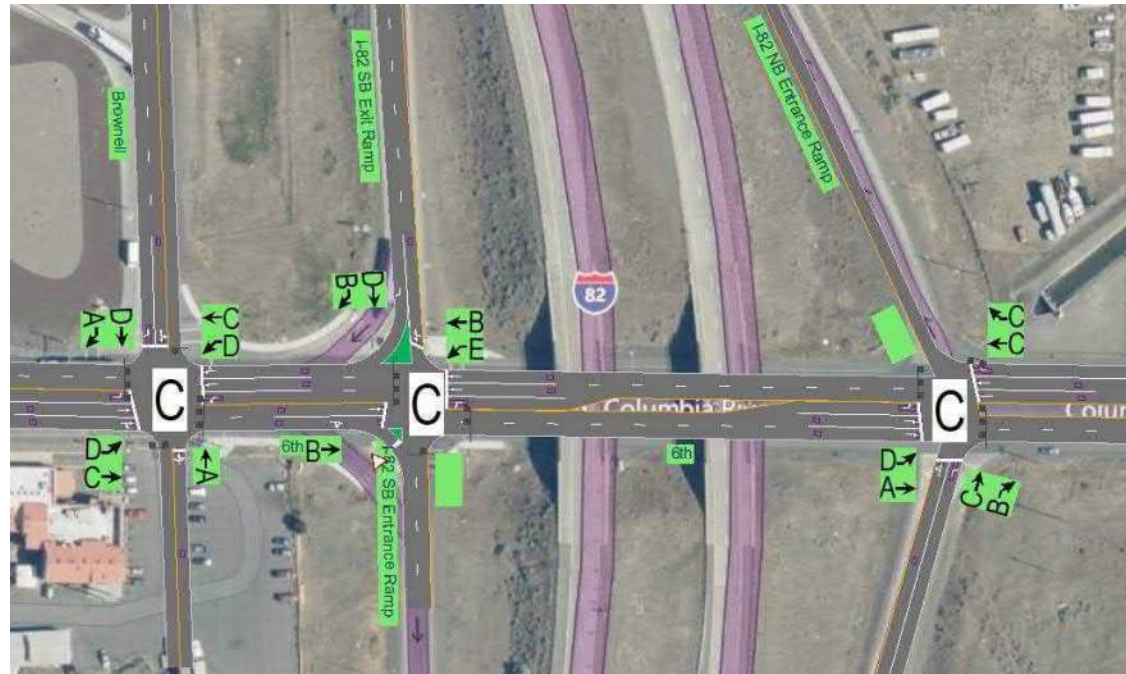

Mitigation Alternative 3 at I-82/Northbound Ramps



Mitigation Alt 3 - LOS and V/C ratios



US 730/US 395 Mitigation Alt 2

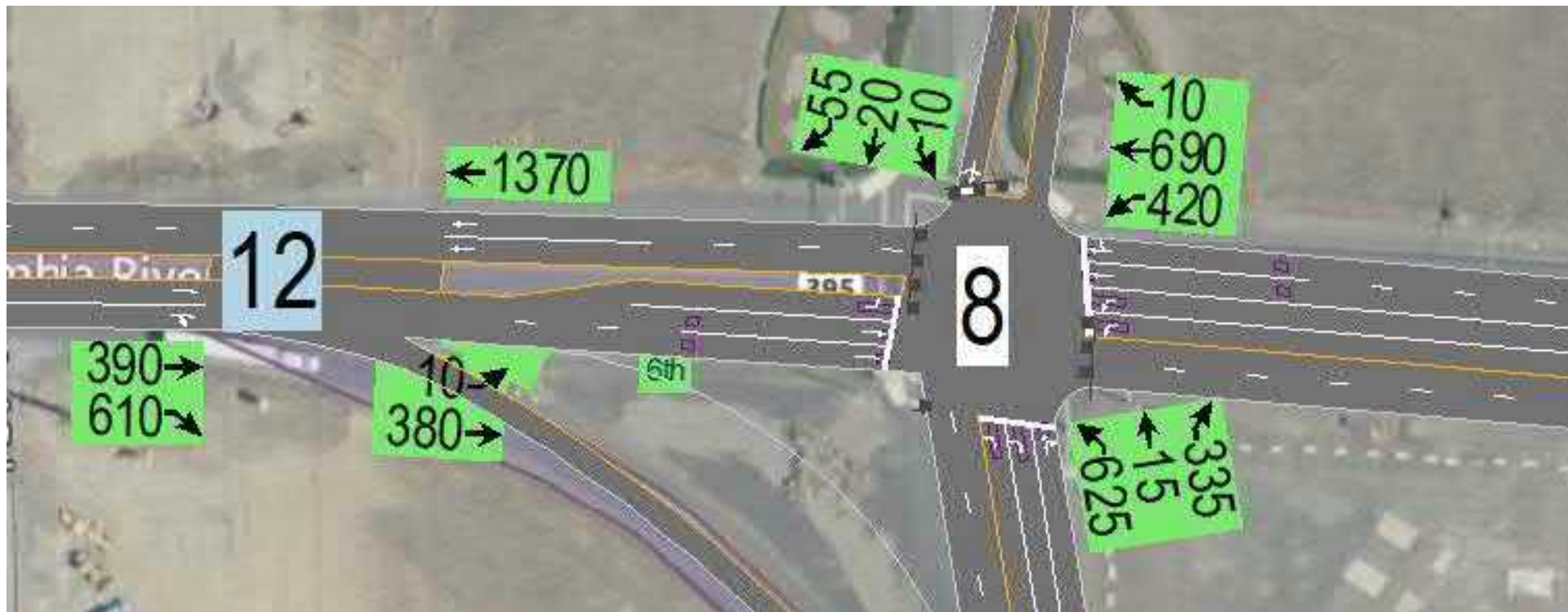

US 730/US 395 Mitigation Alt 2 LOS and V/C ratios

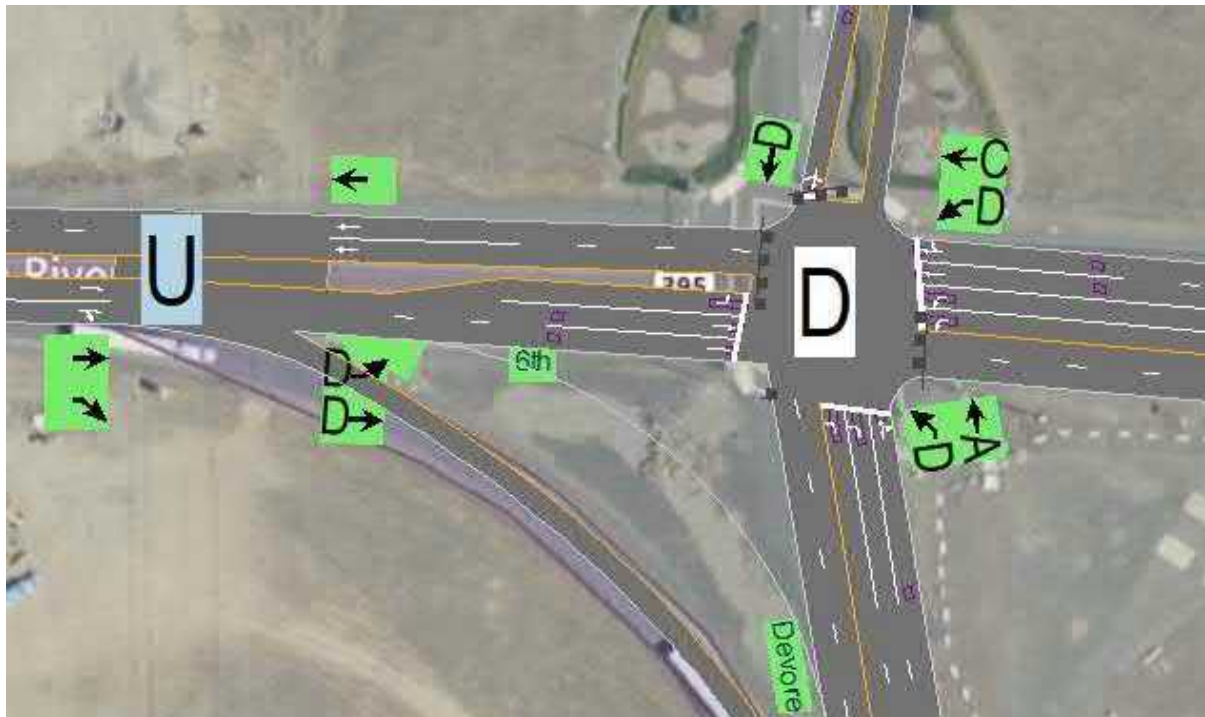

Umatilla Transportation Plan

Future Road Network & Functional Classification System

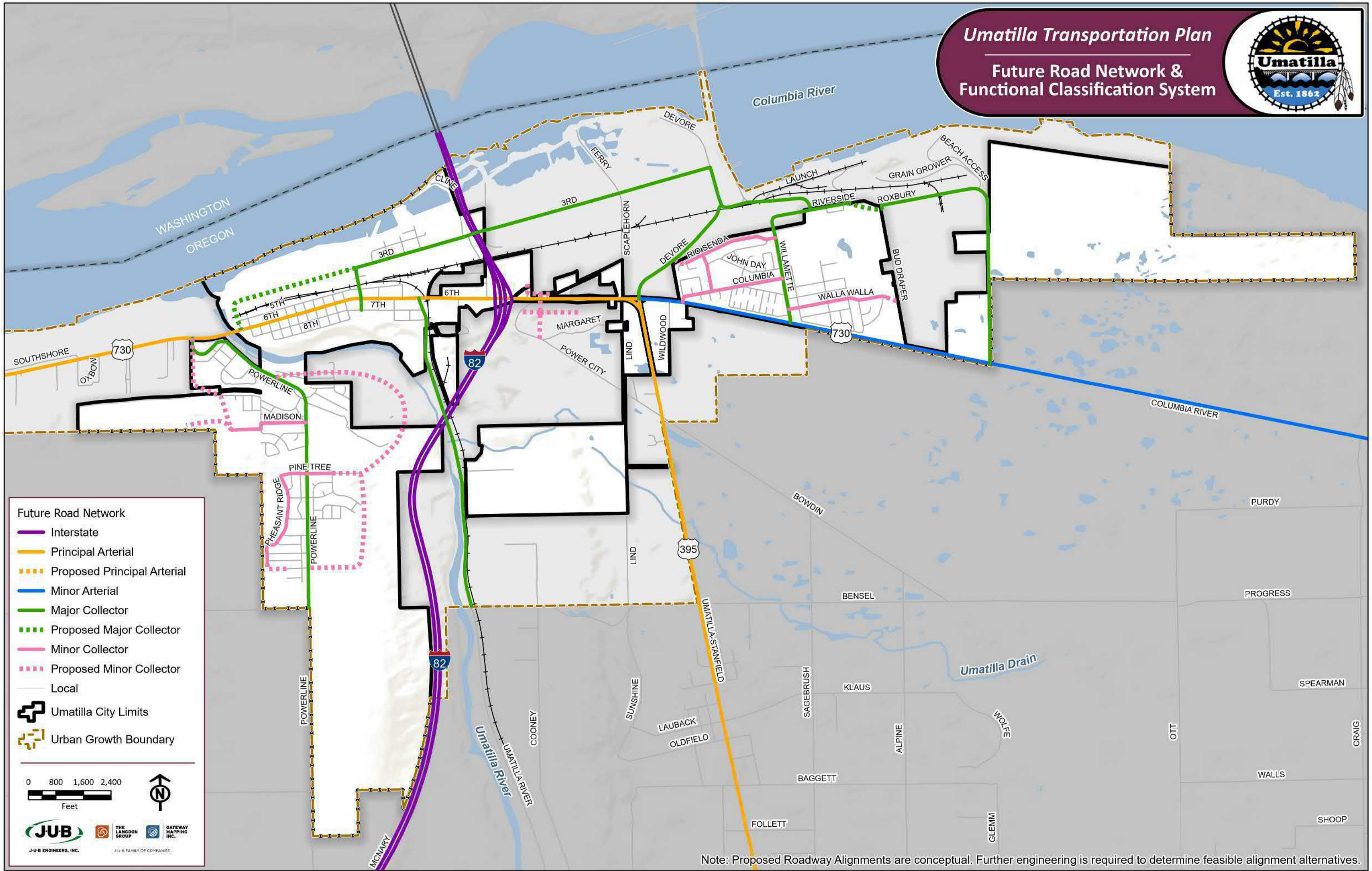

- Future Road Network**
- Interstate
 - Principal Arterial
 - Proposed Principal Arterial
 - Minor Arterial
 - Major Collector
 - Proposed Major Collector
 - Minor Collector
 - Proposed Minor Collector
 - Local
 - Umatilla City Limits
 - Urban Growth Boundary

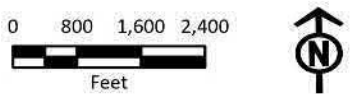

Note: Proposed Roadway Alignments are conceptual. Further engineering is required to determine feasible alignment alternatives.

Umatilla Transportation System Plan
Technical Advisory Committee Meeting #2
November 28, 2022 11:00 AM (held virtually via Teams)

MEETING SUMMARY

1. Introductions

- City of Umatilla City of Umatilla – Brandon Seitz, Jacob Foutz, Scott Coleman, David Stockdale, Scott Green
- J-U-B ENGINEERS, Inc. – Spencer Montgomery, Lisa Sefiken, Elizabeth Smith
- ODOT – Teresa Penninger, Cheryl Jarvis-Smith - ODOT
- Umatilla County – Carol Johnson
- Umatilla School District – Rick Cottrell
- Keith Kennedy – Umatilla Police Department

2. July Open House Public Comments Received

- Open house in July with low attendance
- ~30 comments were received online (Bicycle/Pedestrian, Roadway/Network Connections, Safety, Traffic Congestion)

3. Existing Conditions Overview

- Update on Traffic Volumes and Seasonality
 - Automatic traffic counter on US 730 and I-82 near interchange
 - August is high month for automatic counters
 - Adjust all counts up 12% to represent 30th highest hour, consistent with ODOT methodology
- Capacity Analysis Results

4. Traffic Volumes Forecasting

- Development proposals for South Hill residential areas, TIAs reviewed and combined additional traffic added to network using existing traffic patterns
- East end industrial area development also forecast and backed through network using existing patterns
- Year 2043
- Intermediate Year Forecasts, year of failure identified through capacity analysis

5. Alternatives Analysis

- See table in agenda materials with a summary of alternatives
- Northbound Ramps Alternative 1
 - Under interstate, a traffic light at northbound ramps will help reduce impact from people trying to use the middle lane as an extended queue, should it run the whole width of the interstate?
 - Traffic calming
 - Pedestrian traffic from McNary. Discussion of them being on the north side of US 730 but that long term there should be provision for them on both sides.
 - Westbound right turn lane will negatively impact pedestrian/bicycle traffic
- Multi-modal perspective

- Majority of residents in McNary live north of 730 - #7 is where we need to calm traffic to accommodate ped/bike traffic
- Schools are on the south side of 730 in McNary – how do we get pedestrians to the south side for the schools? Utilize signal protection or 20' separated pathway
- Future Roadway Functionally Classified Network
 - See figure
 - Not all network modifications are illustrated. The modifications will not be removed, but better suited for an appendix.
 - The City's Master Trails Plan has an extensive list of bike/ped/pathway improvements. They are not identified in current network in meeting. Future bike/ped/paths will be included in the final plan.
 - Trails master plan (referenced by TSP) should be the main document
 - More maps for visual guides/figures
 - Value in referencing Old Town access and Vegetative Management document co-authored with the Tribe.
 - Good to mention the past work on studying the Weigh Station, but note that any recommended improvements are not likely to occur during the next 20 years
- Character of Highway 730
 - City has elongated downtown and there is an opportunity to create a better space for ped/bike/transit
 - Add more vegetation, art
 - Electric Charging stations
 - Electric bike parking
- Functional Class Figure – What changes are made?
 - Powerline – Minor to Major
 - ODOT is working to make sure there are consistencies – If changes are made, work with ODOT to get those updates completed.
- Pedestrian Paths
 - Electric Bike Path – That is the preferred pedestrian path for students, creating a completely separate path for anyone biking/walking
 - Shortcut pathways, such as from Devore down to Scaplehorn might help making this new route more attractive and would completely separate non-motorized traffic

6. Next Steps

- Public Participation
 - City suggests putting an Open House item on Council agenda rather than creating a separate meeting – gives face to face opportunity
 - Virtual meeting open for 10-14 days

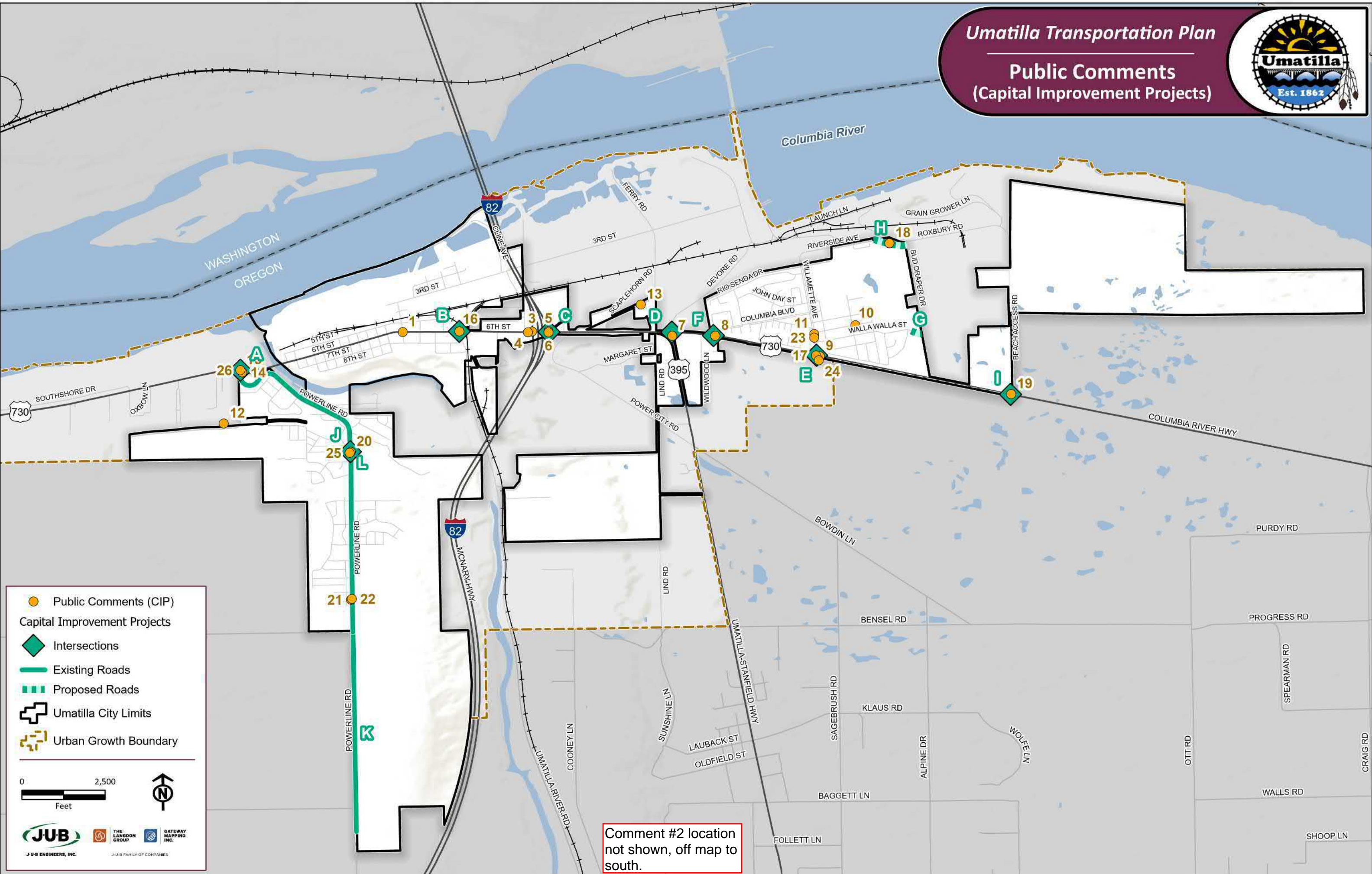

- Public Comments (CIP)
- ◆ Intersections
- Existing Roads
- - - Proposed Roads
- Umatilla City Limits
- Urban Growth Boundary

0 2,500
Feet



JUB THE LANGDON GROUP GATEWAY MAPPING INC.
 J-U-B ENGINEERS, INC. J-U-B FAMILY OF COMPANIES

Comment #2 location not shown, off map to south.

Umatilla Transportation System Plan Public Comments Received after January Open House

ID	Comment
1	Adding a traffic light somewhere else near the school area to create patterns of traffic and to help pedestrians cross more safely
2	Could we figure out an easier way to enter Hermiston from South Hill? Having Elm Street extend over the river and meet with Powerline would be very beneficial for everyone.
3	Traffic Control Lights need better sequencing and the off ramp from I82 EB needs it's own lane, not a merge lane
4	Round-a-bout study. Seems as though round-a-bouts here would produce efficiencies. Take Union Gap's Valley Mall Blvd round-a-bout project for an example. They now have three of them in a combined figure 8 style
5	730 WB getting onto the I82 WB on ramp, needs its own exit lane
6	I82 WB off ramp onto 730 EB, needs its own merge lane, no stop for right turn onto 730
7	NB395 to EB730 needs a free right with dedicated merge lane onto 730 EB
8	With the addition of the coffee stand, the influx of semi trucks stopping at the gas station, mini-mart, this intersection is becoming a mess. Getting to the point a round-a-bout study should be done if not then traffic control devices. The current commented plan isn't horrible but should be thinking further down the road than just the current needs. As what is "planned" would just be suitable for current needs only, no further additional traffic as such will take place
9	With the addition of the coffee stand, the influx of semi trucks stopping at the gas station, mini-mart, this intersection is becoming a mess. Getting to the point a round-a-bout study should be done if not then traffic control devices. The current commented plan isn't horrible but should be thinking further down the road than just the current needs. As what is "planned" would just be suitable for current needs only, no further additional traffic as such will take place
10	Yakima street needs to be marked and labeled as parking on north side only
11	Remove the islands and provide a suicide lane, will give better visibility and reduce impact of vehicles wanting to turn across traffic.
12	A new canal crossing to alleviate the further growth and development of south hill, traffic will need another access point to 730 aside from just powerline
13	Think we should re open the one way exit by the school from McNary to help alleviate traffic on Willamette
14	I would rather see a traffic light here than a roundabout. I think roundabouts would be pretty difficult for semi truck traffic to use.
15	No roundabout!. Instead a right turn lane coming from the west onto Powerline. Also reduce the speed limit down from 40 MPH Also a right turn lane from Powerline onto 730 headed east.
16	Seems to be a good safety measure.

17	Yes
18	Yes
19	Yes
20	Yes
21	Yes
22	Yes
23	improve sidewalks and bike lanes
24	Needs traffic light for McNary
25	Now more than ever with all the growth on south hill, side walks up power line Rd beginning at hwy 730 are a must. Especially with the new school going in. Power line Rd must have sidewalks beginning at hwy 730.
26	B
face-book	I'm still not sure what you have in mind but it would be great to see stop lights where river road meets 730 and one where power line meets 730. I do hope if you find a way to get truck traffic going through Umatilla. I do hope you will do a better job than you did on the side walks making it almost impossible to turn off of 730 with a boat or trailer because you put the sidewalks in the street.
face-book	Something should be done about trucks coming out of the weight station. The constantly block traffic on Brownell.

Appendix J
2043 Build Mitigation Scenario Capacity Analysis
Worksheets

MOVEMENT SUMMARY

Site: Int. 2 [Hwy 730 / P.Line Rd Single In 2043 (Site Folder: General)]

Output produced by SIDRA INTERSECTION Version: 9.1.2.202

2043 Build
 Site Category: (None)
 Roundabout

Vehicle Movement Performance															
Mov ID	Turn	Mov Class	Demand Flows		Arrival Flows		Deg. Satn	Aver. Delay	Level of Service	95% Back Of Queue	Prop. Que	Eff. Stop Rate	Aver. No. of Cycles	Aver. Speed	
			[Total HV]	%	[Total HV]	%	v/c	sec		[Veh.]	[Dist]			mph	
			veh/h		veh/h					veh	ft				
South: Power Line Road NB															
3	L2	All MCs	261	2.0	261	2.0	0.850	28.7	LOS C	17.6	448.1	1.00	1.30	1.95	23.2
18	R2	All MCs	375	2.0	375	2.0	0.850	28.7	LOS C	17.6	448.1	1.00	1.30	1.95	23.4
Approach			636	2.0	636	2.0	0.850	28.7	LOS C	17.6	448.1	1.00	1.30	1.95	23.3
East: Hwy 730 WB															
1	L2	All MCs	516	2.0	516	2.0	0.982	42.2	LOS D	44.2	1123.5	1.00	1.71	2.50	20.4
6	T1	All MCs	424	2.0	424	2.0	0.982	42.2	LOS D	44.2	1123.5	1.00	1.71	2.50	21.3
Approach			940	2.0	940	2.0	0.982	42.2	LOS D	44.2	1123.5	1.00	1.71	2.50	20.8
West: Hwy 730 EB															
2	T1	All MCs	495	2.0	495	2.0	1.034	62.9	LOS F	37.4	949.2	1.00	1.97	3.35	18.1
12	R2	All MCs	250	2.0	250	2.0	1.034	62.9	LOS F	37.4	949.2	1.00	1.97	3.35	17.5
Approach			745	2.0	745	2.0	1.034	62.9	LOS E	37.4	949.2	1.00	1.97	3.35	17.9
All Vehicles			2321	2.0	2321	2.0	1.034	45.1	LOS D	44.2	1123.5	1.00	1.68	2.62	20.4

Site Level of Service (LOS) Method: Delay & v/c (HCM 6). Site LOS Method is specified in the Parameter Settings dialog (Options tab).

Roundabout LOS Method: Same as Signalised Intersections.

Vehicle movement LOS values are based on average delay and v/c ratio (degree of saturation) per movement.

LOS F will result if v/c > 1 irrespective of movement delay value (does not apply for approaches and intersection).

Intersection and Approach LOS values are based on average delay for all movements (v/c not used as specified in HCM 6).

Roundabout Capacity Model: SIDRA HCM.

Delay Model: HCM Delay Formula (Stopline Delay: Geometric Delay is not included).

Queue Model: SIDRA queue estimation methods are used for Back of Queue and Queue at Start of Gap.

Gap-Acceptance Capacity Formula: SIDRA Standard (Akçelik M3D).

HV (%) values are calculated for All Movement Classes of All Heavy Vehicle Model Designation.

Arrival Flows used in performance calculations are adjusted to include any Initial Queued Demand and Upstream Capacity Constraint effects.

SIDRA INTERSECTION 9.1 | Copyright © 2000-2022 Akcelik and Associates Pty Ltd | sidrasolutions.com

Organisation: J.U.B ENGINEERS, INC. | Licence: PLUS / 1PC | Processed: Thursday, January 12, 2023 11:12:31 AM

Project: \\jub.com\central\Clients\OR\UmatillaCity\Projects\07-22-008_TransportationSystemPlan\Planning\Traffic\Sidra\Hwy 730_Powerline Rd.sip9

SITE LAYOUT

Site: Int. 2 [Hwy 730 / P.Line Rd Single In 2043 (Site Folder: General)]

2043 Build
Site Category: (None)
Roundabout

Layout pictures are schematic functional drawings reflecting input data. They are not design drawings.

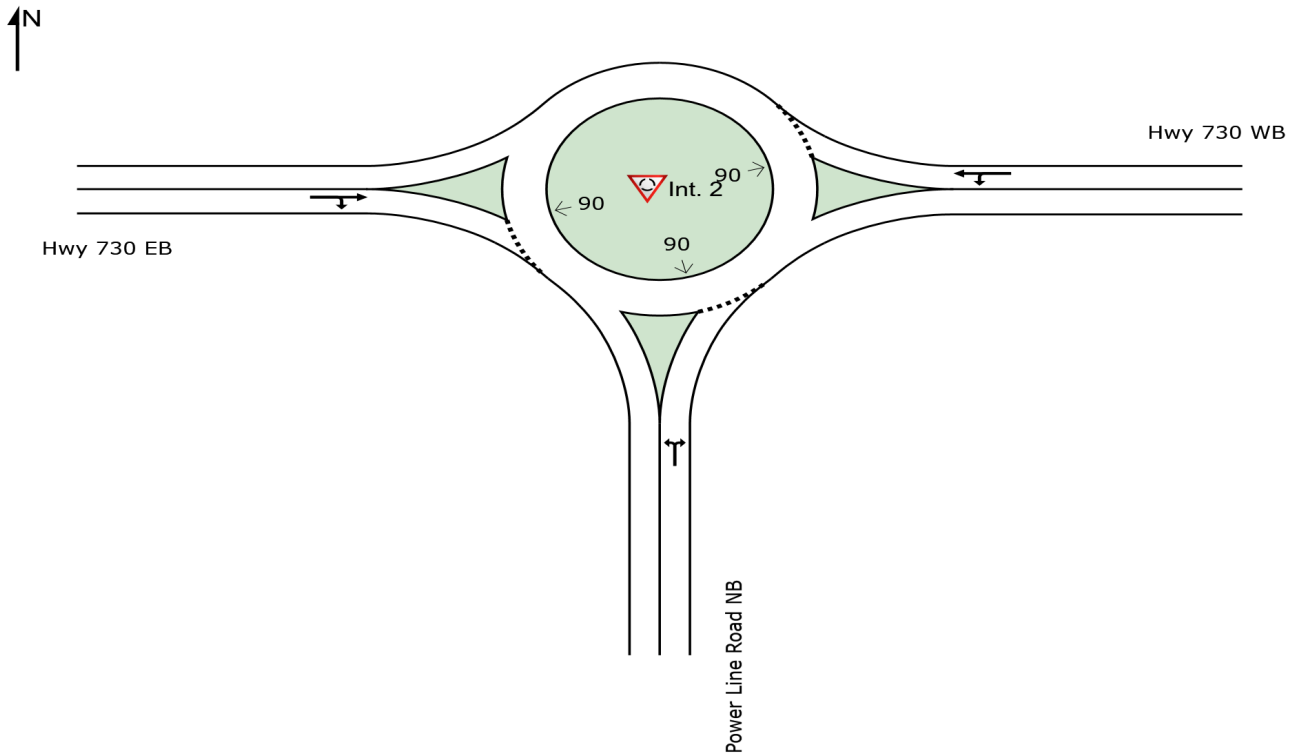

MOVEMENT SUMMARY

Site: Int. 2 [Hwy 730 / P.Line Rd EBR 2043 (Site Folder: General)]

Output produced by SIDRA INTERSECTION Version: 9.1.2.202

2043 Build
 Site Category: (None)
 Roundabout

Vehicle Movement Performance															
Mov ID	Turn	Mov Class	Demand Flows		Arrival Flows		Deg. Satn	Aver. Delay	Level of Service	95% Back Of Queue	Prop. Que	Eff. Stop Rate	Aver. No. of Cycles	Aver. Speed	
			[Total HV]	%	[Total HV]	%	v/c	sec		[Veh.]	[Dist]			mph	
			veh/h		veh/h					veh	ft				
South: Power Line Road NB															
3	L2	All MCs	261	2.0	261	2.0	0.845	28.0	LOS C	17.2	437.3	1.00	1.29	1.94	23.4
18	R2	All MCs	375	2.0	375	2.0	0.845	28.0	LOS C	17.2	437.3	1.00	1.29	1.94	23.6
Approach			636	2.0	636	2.0	0.845	28.0	LOS C	17.2	437.3	1.00	1.29	1.94	23.5
East: Hwy 730 WB															
1	L2	All MCs	516	2.0	516	2.0	0.982	42.2	LOS D	44.2	1123.5	1.00	1.71	2.50	20.4
6	T1	All MCs	424	2.0	424	2.0	0.982	42.2	LOS D	44.2	1123.5	1.00	1.71	2.50	21.3
Approach			940	2.0	940	2.0	0.982	42.2	LOS D	44.2	1123.5	1.00	1.71	2.50	20.8
West: Hwy 730 EB															
2	T1	All MCs	495	2.0	495	2.0	0.547	11.3	LOS B	5.7	144.4	0.90	0.71	1.03	31.0
12	R2	All MCs	250	2.0	250	2.0	0.359	9.8	LOS A	2.6	66.0	0.81	0.61	0.81	29.7
Approach			745	2.0	745	2.0	0.547	10.8	LOS B	5.7	144.4	0.87	0.68	0.96	30.6
All Vehicles			2321	2.0	2321	2.0	0.982	28.2	LOS C	44.2	1123.5	0.96	1.27	1.85	24.0

Site Level of Service (LOS) Method: Delay & v/c (HCM 6). Site LOS Method is specified in the Parameter Settings dialog (Options tab).

Roundabout LOS Method: Same as Signalised Intersections.

Vehicle movement LOS values are based on average delay and v/c ratio (degree of saturation) per movement.

LOS F will result if v/c > 1 irrespective of movement delay value (does not apply for approaches and intersection).

Intersection and Approach LOS values are based on average delay for all movements (v/c not used as specified in HCM 6).

Roundabout Capacity Model: SIDRA HCM.

Delay Model: HCM Delay Formula (Stopline Delay: Geometric Delay is not included).

Queue Model: SIDRA queue estimation methods are used for Back of Queue and Queue at Start of Gap.

Gap-Acceptance Capacity Formula: SIDRA Standard (Akçelik M3D).

HV (%) values are calculated for All Movement Classes of All Heavy Vehicle Model Designation.

Arrival Flows used in performance calculations are adjusted to include any Initial Queued Demand and Upstream Capacity Constraint effects.

SIDRA INTERSECTION 9.1 | Copyright © 2000-2022 Akcelik and Associates Pty Ltd | sidrasolutions.com

Organisation: J.U.B ENGINEERS, INC. | Licence: PLUS / 1PC | Processed: Thursday, January 12, 2023 11:13:42 AM

Project: \\jub.com\central\Clients\OR\UmatillaCity\Projects\07-22-008_TransportationSystemPlan\Planning\Traffic\Sidra\Hwy 730_Powerline Rd.sip9

SITE LAYOUT

Site: Int. 2 [Hwy 730 / P.Line Rd EBR 2043 (Site Folder: General)]

2043 Build
Site Category: (None)
Roundabout

Layout pictures are schematic functional drawings reflecting input data. They are not design drawings.

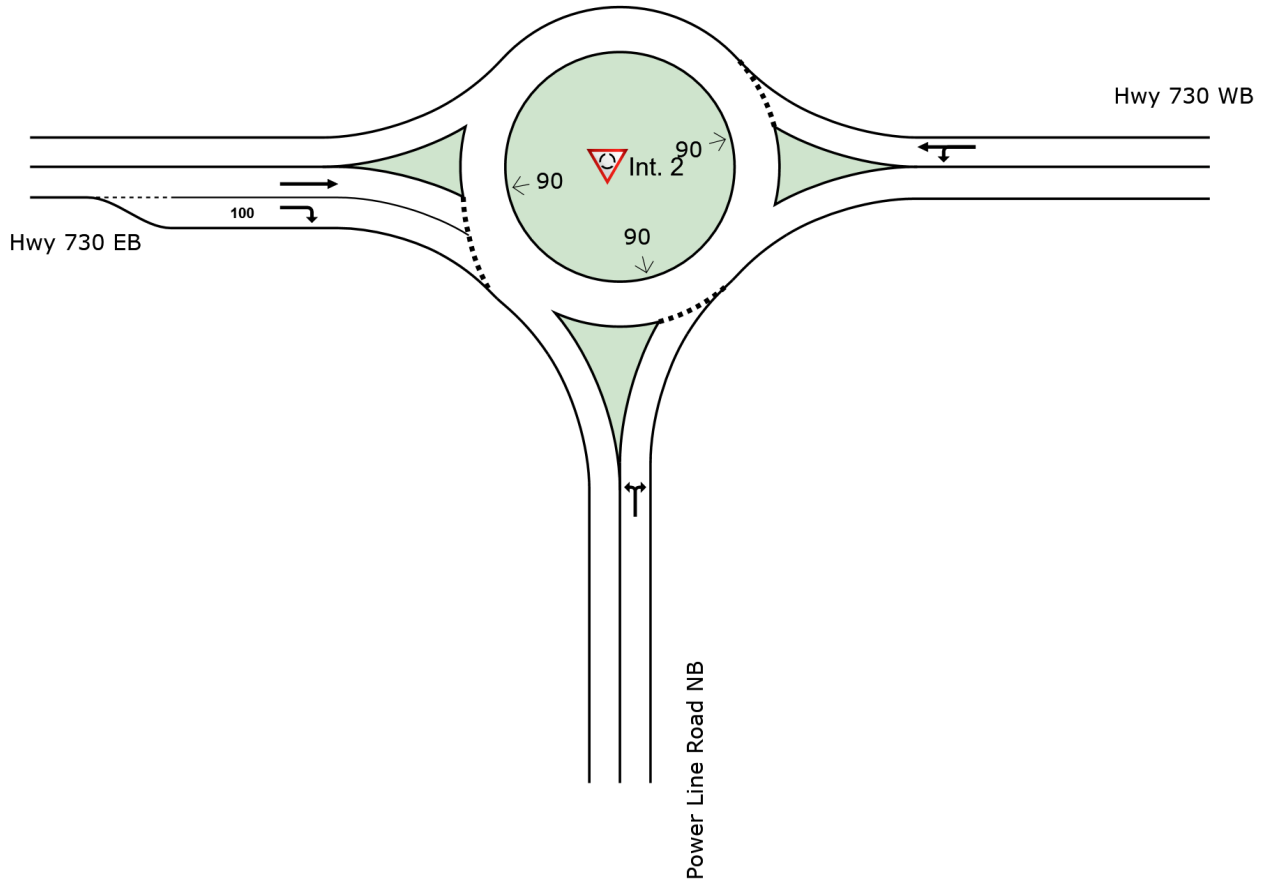

MOVEMENT SUMMARY

Site: Int. 4 [Hwy 730 / Umatilla River Rd (Site Folder: General)]

Output produced by SIDRA INTERSECTION Version: 9.1.2.202

2043 Build
Site Category: (None)
Roundabout

Vehicle Movement Performance															
Mov ID	Turn	Mov Class	Demand Flows		Arrival Flows		Deg. Satn	Aver. Delay	Level of Service	95% Back Of Queue	Prop. Que	Eff. Stop Rate	Aver. No. of Cycles	Aver. Speed	
			[Total HV]	%	[Total HV]	%	v/c	sec		[Veh. veh	Dist]			mph	
South: Umatilla River Road NB															
3	L2	All MCs	201	2.0	201	2.0	0.606	18.6	LOS B	6.1	155.6	0.99	0.96	1.31	21.2
18	R2	All MCs	136	2.0	136	2.0	0.606	18.6	LOS B	6.1	155.6	0.99	0.96	1.31	22.7
Approach			337	2.0	337	2.0	0.606	18.6	LOS B	6.1	155.6	0.99	0.96	1.31	21.7
East: Hwy 730 WB															
1	L2	All MCs	158	2.0	158	2.0	0.932	31.1	LOS C	38.0	964.9	1.00	1.47	1.95	20.5
6	T1	All MCs	815	2.0	815	2.0	0.932	31.1	LOS C	38.0	964.9	1.00	1.47	1.95	19.5
Approach			973	2.0	973	2.0	0.932	31.1	LOS C	38.0	964.9	1.00	1.47	1.95	19.6
West: Hwy 730 EB															
2	T1	All MCs	723	2.0	723	2.0	0.871	22.8	LOS C	27.2	689.9	1.00	1.03	1.45	21.2
12	R2	All MCs	228	2.0	228	2.0	0.871	22.8	LOS C	27.2	689.9	1.00	1.03	1.45	21.1
Approach			951	2.0	951	2.0	0.871	22.8	LOS C	27.2	689.9	1.00	1.03	1.45	21.1
All Vehicles			2261	2.0	2261	2.0	0.932	25.7	LOS C	38.0	964.9	1.00	1.21	1.64	20.5

Site Level of Service (LOS) Method: Delay & v/c (HCM 6). Site LOS Method is specified in the Parameter Settings dialog (Options tab).

Roundabout LOS Method: Same as Signalised Intersections.

Vehicle movement LOS values are based on average delay and v/c ratio (degree of saturation) per movement.

LOS F will result if v/c > 1 irrespective of movement delay value (does not apply for approaches and intersection).

Intersection and Approach LOS values are based on average delay for all movements (v/c not used as specified in HCM 6).

Roundabout Capacity Model: SIDRA HCM.

Delay Model: HCM Delay Formula (Stopline Delay: Geometric Delay is not included).

Queue Model: SIDRA queue estimation methods are used for Back of Queue and Queue at Start of Gap.

Gap-Acceptance Capacity Formula: SIDRA Standard (Akçelik M3D).

HV (%) values are calculated for All Movement Classes of All Heavy Vehicle Model Designation.

Arrival Flows used in performance calculations are adjusted to include any Initial Queued Demand and Upstream Capacity Constraint effects.

SIDRA INTERSECTION 9.1 | Copyright © 2000-2022 Akcelik and Associates Pty Ltd | sidrasolutions.com

Organisation: J.U.B ENGINEERS, INC. | Licence: PLUS / 1PC | Processed: Thursday, January 12, 2023 11:42:26 AM

Project: \\jub.com\central\Clients\OR\UmatillaCity\Projects\07-22-008_TransportationSystemPlan\Planning\Traffic\Sidra\Hwy 730_Umatilla River Rd.sip9

SITE LAYOUT

Site: Int. 4 [Hwy 730 / Umatilla River Rd (Site Folder: General)]

2043 Build
Site Category: (None)
Roundabout

Layout pictures are schematic functional drawings reflecting input data. They are not design drawings.

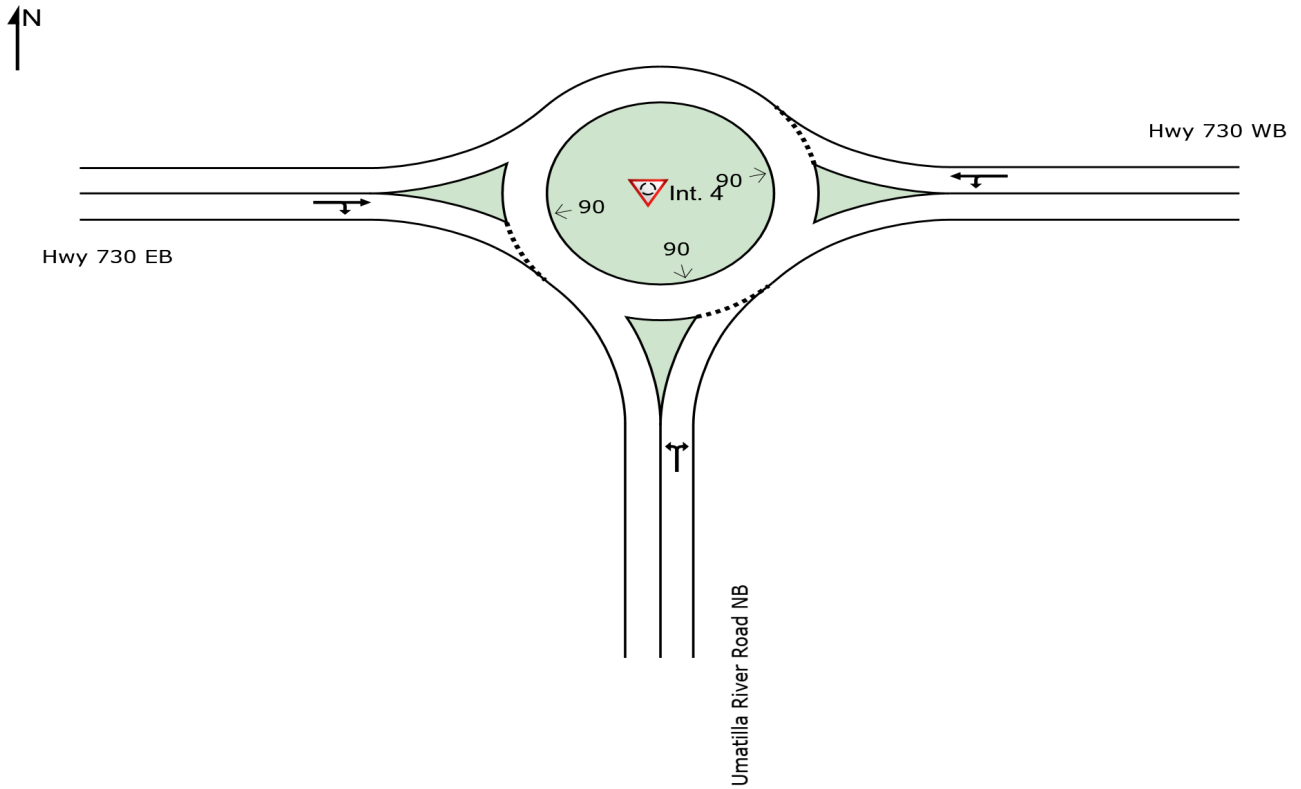

Mitigation Alternative 1 at I-82/Northbound Ramps



Mitigation Alt 1 -- LOS and V/C ratios



Mitigation Alternative 3 at I-82/Northbound Ramps

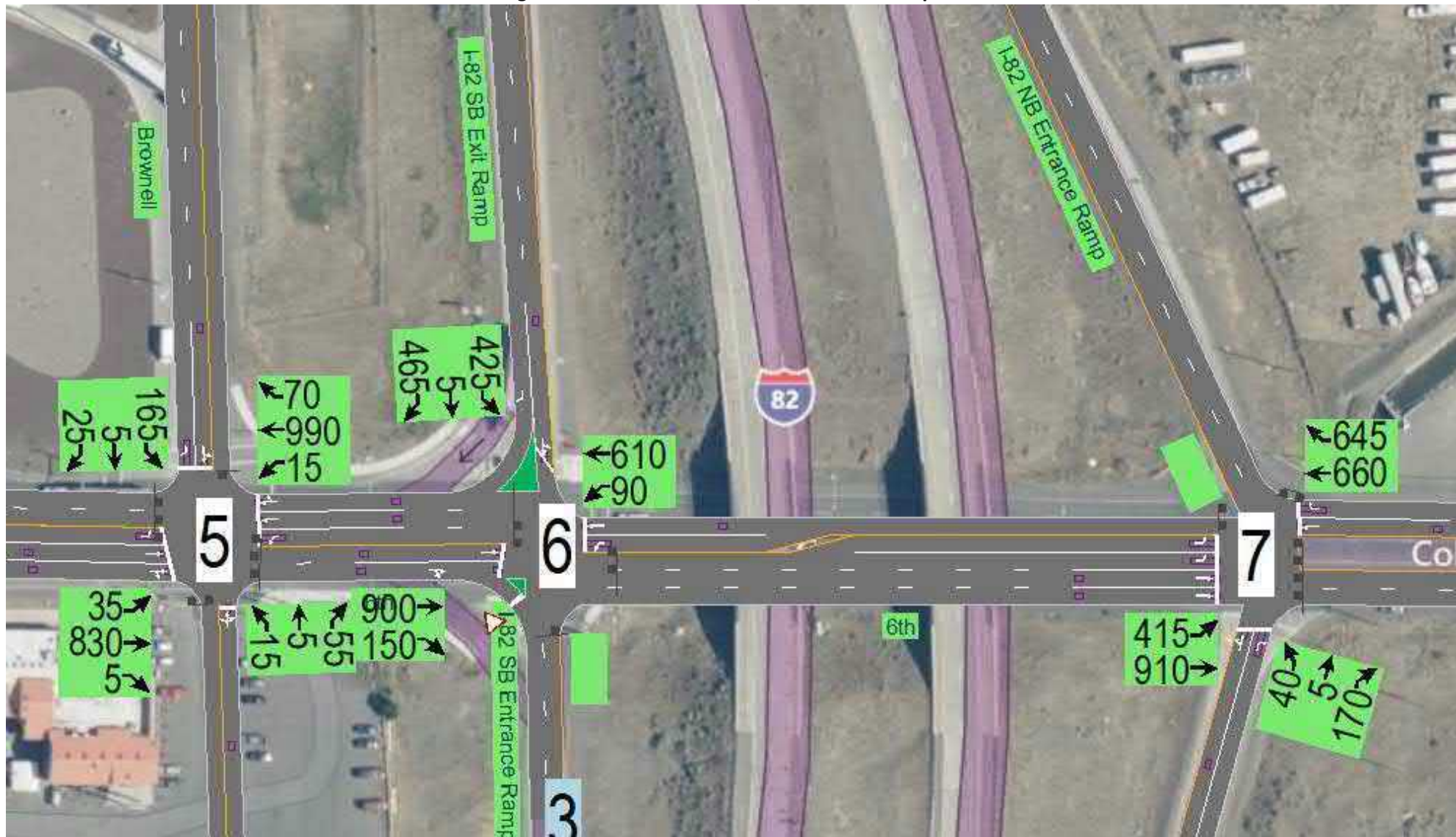

Mitigation Alt 3 - LOS and V/C ratios



US 730/US 395 Mitigation Alt 2

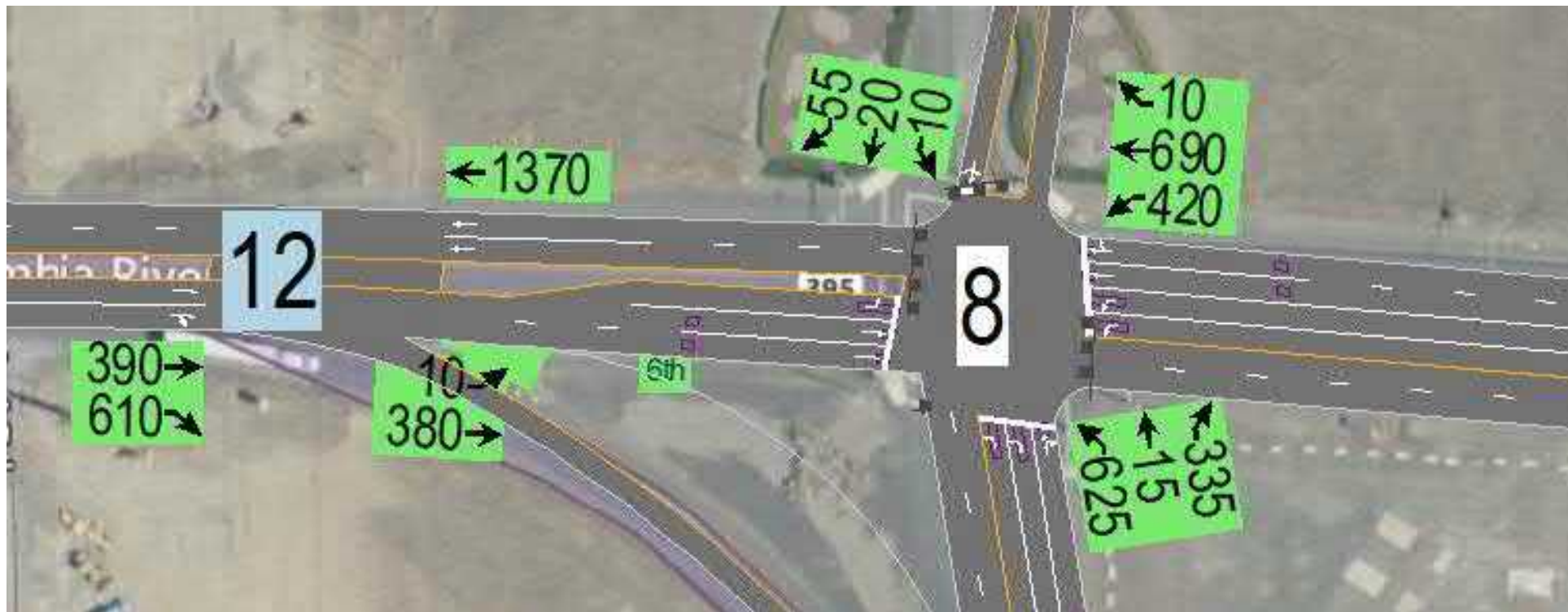

US 730/US 395 Mitigation Alt 2 LOS and V/C ratios

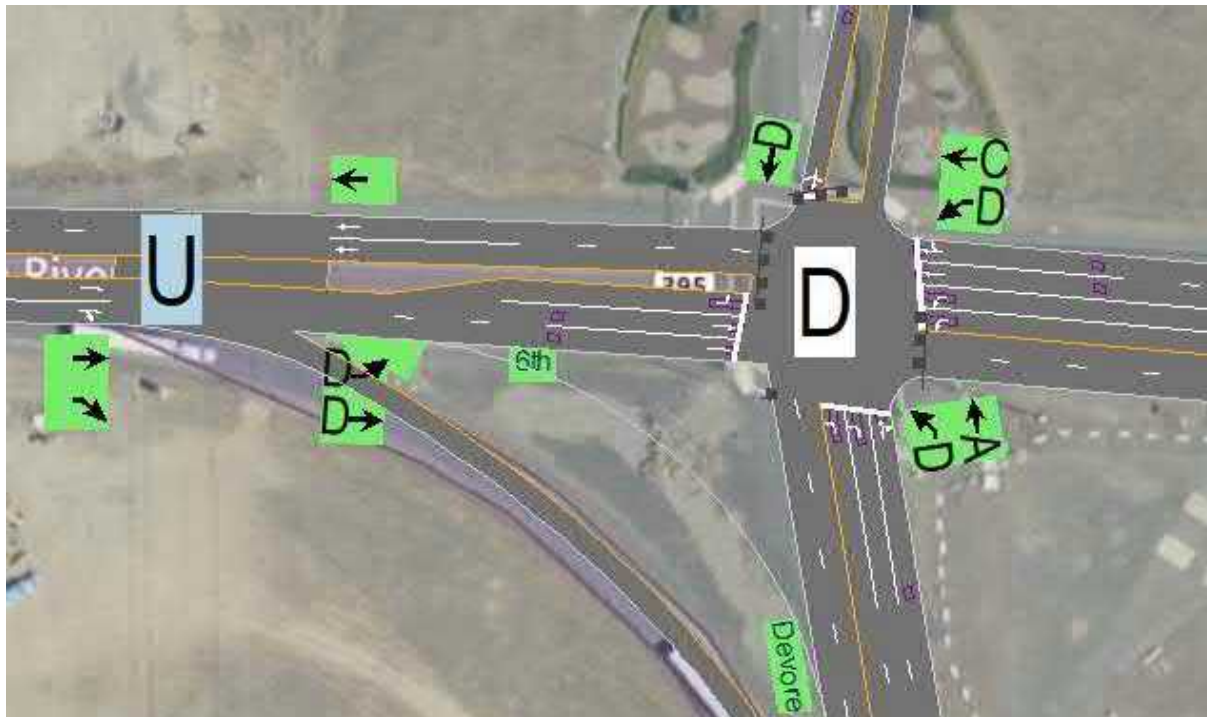

Lanes, Volumes, Timings
2: Powerline & Hwy 730

11/08/2022



Lane Group	EBT	EBR	WBL	WBT	NBL	NBR
Lane Configurations						
Traffic Volume (vph)	455	230	475	390	240	345
Future Volume (vph)	455	230	475	390	240	345
Ideal Flow (vphpl)	1900	1900	1900	1900	1900	1900
Storage Length (ft)		100	300		0	150
Storage Lanes		0	1		1	0
Taper Length (ft)			100		25	
Lane Util. Factor	1.00	1.00	1.00	1.00	1.00	1.00
Frt	0.955				0.920	
Flt Protected			0.950		0.980	
Satd. Flow (prot)	1779	0	1770	1863	1679	0
Flt Permitted			0.114		0.980	
Satd. Flow (perm)	1779	0	212	1863	1679	0
Right Turn on Red		Yes				Yes
Satd. Flow (RTOR)	31				84	
Link Speed (mph)	40			40	35	
Link Distance (ft)	728			823	449	
Travel Time (s)	12.4			14.0	8.7	
Peak Hour Factor	0.92	0.92	0.92	0.92	0.92	0.92
Adj. Flow (vph)	495	250	516	424	261	375
Shared Lane Traffic (%)						
Lane Group Flow (vph)	745	0	516	424	636	0
Enter Blocked Intersection	No	No	No	No	No	No
Lane Alignment	Left	Right	Left	Left	Left	Right
Median Width(ft)	12			12	12	
Link Offset(ft)	0			0	0	
Crosswalk Width(ft)	16			16	16	
Two way Left Turn Lane						
Headway Factor	1.00	1.00	1.00	1.00	1.00	1.00
Turning Speed (mph)		9	15		15	9
Number of Detectors	2		1	2	1	
Detector Template	Thru		Left	Thru	Left	
Leading Detector (ft)	100		20	100	20	
Trailing Detector (ft)	0		0	0	0	
Detector 1 Position(ft)	0		0	0	0	
Detector 1 Size(ft)	6		20	6	20	
Detector 1 Type	Cl+Ex		Cl+Ex	Cl+Ex	Cl+Ex	
Detector 1 Channel						
Detector 1 Extend (s)	0.0		0.0	0.0	0.0	
Detector 1 Queue (s)	0.0		0.0	0.0	0.0	
Detector 1 Delay (s)	0.0		0.0	0.0	0.0	
Detector 2 Position(ft)	94			94		
Detector 2 Size(ft)	6			6		
Detector 2 Type	Cl+Ex			Cl+Ex		
Detector 2 Channel						
Detector 2 Extend (s)	0.0			0.0		
Turn Type	NA		pm+pt	NA	Prot	
Protected Phases	4		3	8	2	
Permitted Phases			8			

Lanes, Volumes, Timings
2: Powerline & Hwy 730

11/08/2022



Lane Group	EBT	EBR	WBL	WBT	NBL	NBR
Detector Phase	4		3	8	2	
Switch Phase						
Minimum Initial (s)	5.0		5.0	5.0	5.0	
Minimum Split (s)	22.5		9.5	22.5	22.5	
Total Split (s)	35.0		22.0	57.0	33.0	
Total Split (%)	38.9%		24.4%	63.3%	36.7%	
Maximum Green (s)	30.5		17.5	52.5	28.5	
Yellow Time (s)	3.5		3.5	3.5	3.5	
All-Red Time (s)	1.0		1.0	1.0	1.0	
Lost Time Adjust (s)	0.0		0.0	0.0	0.0	
Total Lost Time (s)	4.5		4.5	4.5	4.5	
Lead/Lag	Lag		Lead			
Lead-Lag Optimize?	Yes		Yes			
Vehicle Extension (s)	3.0		3.0	3.0	3.0	
Recall Mode	None		None	None	C-Max	
Walk Time (s)	7.0			7.0	7.0	
Flash Dont Walk (s)	11.0			11.0	11.0	
Pedestrian Calls (#/hr)	0			0	0	
Act Effct Green (s)	30.5		52.5	52.5	28.5	
Actuated g/C Ratio	0.34		0.58	0.58	0.32	
v/c Ratio	1.20		1.21	0.39	1.08	
Control Delay	131.6		140.5	11.4	88.3	
Queue Delay	0.0		0.0	0.0	0.0	
Total Delay	131.6		140.5	11.4	88.3	
LOS	F		F	B	F	
Approach Delay	131.6			82.3	88.3	
Approach LOS	F			F	F	
Queue Length 50th (ft)	~508		~313	120	~374	
Queue Length 95th (ft)	#730		#510	182	#584	
Internal Link Dist (ft)	648			743	369	
Turn Bay Length (ft)			300			
Base Capacity (vph)	623		426	1086	589	
Starvation Cap Reductn	0		0	0	0	
Spillback Cap Reductn	0		0	0	0	
Storage Cap Reductn	0		0	0	0	
Reduced v/c Ratio	1.20		1.21	0.39	1.08	

Intersection Summary

Area Type: Other
 Cycle Length: 90
 Actuated Cycle Length: 90
 Offset: 0 (0%), Referenced to phase 2:NBL and 6:, Start of Green
 Natural Cycle: 90
 Control Type: Actuated-Coordinated
 Maximum v/c Ratio: 1.21
 Intersection Signal Delay: 99.8
 Intersection LOS: F
 Intersection Capacity Utilization 110.0%
 ICU Level of Service H
 Analysis Period (min) 15
 ~ Volume exceeds capacity, queue is theoretically infinite.

Lanes, Volumes, Timings

2: Powerline & Hwy 730

11/08/2022

Queue shown is maximum after two cycles.

95th percentile volume exceeds capacity, queue may be longer.

Queue shown is maximum after two cycles.

Splits and Phases: 2: Powerline & Hwy 730



Lanes, Volumes, Timings

4:

11/08/2022

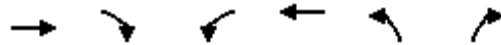

Lane Group	EBT	EBR	WBL	WBT	NBL	NBR
Lane Configurations	↑	↑	↓	↑	↓	
Traffic Volume (vph)	665	210	145	750	185	125
Future Volume (vph)	665	210	145	750	185	125
Ideal Flow (vphpl)	1900	1900	1900	1900	1900	1900
Storage Length (ft)		127	150		0	30
Storage Lanes		1	1		1	0
Taper Length (ft)			75		25	
Lane Util. Factor	1.00	1.00	1.00	1.00	1.00	1.00
Frt		0.850			0.946	
Flt Protected			0.950		0.971	
Satd. Flow (prot)	1863	1583	1770	1863	1711	0
Flt Permitted			0.127		0.971	
Satd. Flow (perm)	1863	1583	237	1863	1711	0
Right Turn on Red		Yes				Yes
Satd. Flow (RTOR)		184			53	
Link Speed (mph)	45			45	45	
Link Distance (ft)	1042			902	649	
Travel Time (s)	15.8			13.7	9.8	
Peak Hour Factor	0.92	0.92	0.92	0.92	0.92	0.92
Adj. Flow (vph)	723	228	158	815	201	136
Shared Lane Traffic (%)						
Lane Group Flow (vph)	723	228	158	815	337	0
Enter Blocked Intersection	No	No	No	No	No	No
Lane Alignment	Left	Right	Left	Left	Left	Right
Median Width(ft)	12			12	12	
Link Offset(ft)	0			0	0	
Crosswalk Width(ft)	16			16	16	
Two way Left Turn Lane	Yes					
Headway Factor	1.00	1.00	1.00	1.00	1.00	1.00
Turning Speed (mph)		9	15		15	9
Number of Detectors	2	1	1	2	1	
Detector Template	Thru	Right	Left	Thru	Left	
Leading Detector (ft)	100	20	20	100	20	
Trailing Detector (ft)	0	0	0	0	0	
Detector 1 Position(ft)	0	0	0	0	0	
Detector 1 Size(ft)	6	20	20	6	20	
Detector 1 Type	Cl+Ex	Cl+Ex	Cl+Ex	Cl+Ex	Cl+Ex	
Detector 1 Channel						
Detector 1 Extend (s)	0.0	0.0	0.0	0.0	0.0	
Detector 1 Queue (s)	0.0	0.0	0.0	0.0	0.0	
Detector 1 Delay (s)	0.0	0.0	0.0	0.0	0.0	
Detector 2 Position(ft)	94			94		
Detector 2 Size(ft)	6			6		
Detector 2 Type	Cl+Ex			Cl+Ex		
Detector 2 Channel						
Detector 2 Extend (s)	0.0			0.0		
Turn Type	NA	Perm	pm+pt	NA	Prot	
Protected Phases	4		3	8	2	
Permitted Phases		4	8			

Lanes, Volumes, Timings

4:

11/08/2022

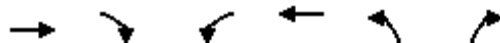

Lane Group	EBT	EBR	WBL	WBT	NBL	NBR
Detector Phase	4	4	3	8	2	
Switch Phase						
Minimum Initial (s)	5.0	5.0	5.0	5.0	5.0	
Minimum Split (s)	22.5	22.5	9.5	22.5	22.5	
Total Split (s)	32.0	32.0	9.5	41.5	23.5	
Total Split (%)	49.2%	49.2%	14.6%	63.8%	36.2%	
Maximum Green (s)	27.5	27.5	5.0	37.0	19.0	
Yellow Time (s)	3.5	3.5	3.5	3.5	3.5	
All-Red Time (s)	1.0	1.0	1.0	1.0	1.0	
Lost Time Adjust (s)	0.0	0.0	0.0	0.0	0.0	
Total Lost Time (s)	4.5	4.5	4.5	4.5	4.5	
Lead/Lag	Lag	Lag	Lead			
Lead-Lag Optimize?	Yes	Yes	Yes			
Vehicle Extension (s)	3.0	3.0	3.0	3.0	3.0	
Recall Mode	None	None	None	None	C-Max	
Walk Time (s)	7.0	7.0		7.0	7.0	
Flash Dont Walk (s)	11.0	11.0		11.0	11.0	
Pedestrian Calls (#/hr)	0	0		0	0	
Act Effct Green (s)	26.9	26.9	36.4	36.4	19.6	
Actuated g/C Ratio	0.41	0.41	0.56	0.56	0.30	
v/c Ratio	0.94	0.30	0.63	0.78	0.61	
Control Delay	41.1	4.6	20.6	17.8	22.1	
Queue Delay	0.0	0.0	0.0	0.0	0.0	
Total Delay	41.1	4.6	20.6	17.8	22.1	
LOS	D	A	C	B	C	
Approach Delay	32.4			18.3	22.1	
Approach LOS	C			B	C	
Queue Length 50th (ft)	259	10	27	222	96	
Queue Length 95th (ft)	#469	47	#79	367	175	
Internal Link Dist (ft)	962			822	569	
Turn Bay Length (ft)		127	150			
Base Capacity (vph)	788	775	250	1060	553	
Starvation Cap Reductn	0	0	0	0	0	
Spillback Cap Reductn	0	0	0	0	0	
Storage Cap Reductn	0	0	0	0	0	
Reduced v/c Ratio	0.92	0.29	0.63	0.77	0.61	

Intersection Summary

Area Type: Other
 Cycle Length: 65
 Actuated Cycle Length: 65
 Offset: 0 (0%), Referenced to phase 2:NBL and 6:, Start of Green
 Natural Cycle: 65
 Control Type: Actuated-Coordinated
 Maximum v/c Ratio: 0.94
 Intersection Signal Delay: 24.8
 Intersection LOS: C
 Intersection Capacity Utilization 72.2%
 ICU Level of Service C
 Analysis Period (min) 15
 # 95th percentile volume exceeds capacity, queue may be longer.

Lanes, Volumes, Timings

4:

11/08/2022

Queue shown is maximum after two cycles.

Splits and Phases: 4:

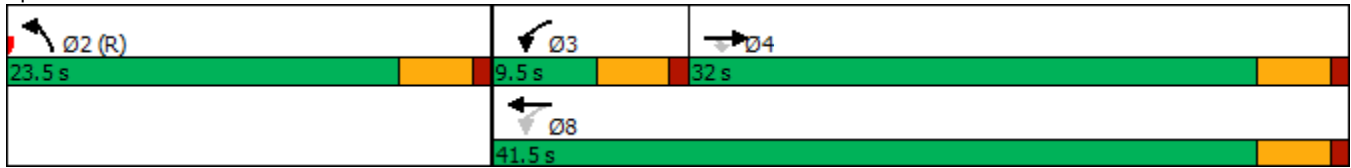

Lanes, Volumes, Timings
5: 6th & Brownell

11/08/2022

Lane Group	EBL	EBT	EBR	WBL	WBT	WBR	NBL	NBT	NBR	SBL	SBT	SBR
Lane Configurations												
Traffic Volume (vph)	35	830	5	15	990	70	15	5	55	165	5	25
Future Volume (vph)	35	830	5	15	990	70	15	5	55	165	5	25
Ideal Flow (vphpl)	1900	1900	1900	1900	1900	1900	1900	1900	1900	1900	1900	1900
Storage Length (ft)	165		0	0		0	0		0	0		0
Storage Lanes	1		0	1		0	0		0	0		1
Taper Length (ft)	135			25			25			25		
Lane Util. Factor	1.00	0.95	0.95	1.00	0.95	0.95	1.00	1.00	1.00	1.00	1.00	1.00
Frt		0.999			0.990			0.901				0.850
Flt Protected	0.950			0.950				0.990			0.954	
Satd. Flow (prot)	1703	3402	0	1556	3081	0	0	1599	0	0	1119	997
Flt Permitted	0.950			0.950				0.934			0.697	
Satd. Flow (perm)	1703	3402	0	1556	3081	0	0	1508	0	0	817	997
Right Turn on Red			Yes			Yes			Yes			Yes
Satd. Flow (RTOR)		1			10			65				69
Link Speed (mph)		35			35			30				30
Link Distance (ft)		1078			236			248				460
Travel Time (s)		21.0			4.6			5.6				10.5
Peak Hour Factor	0.81	0.81	0.81	0.89	0.89	0.89	0.84	0.84	0.84	0.93	0.93	0.93
Heavy Vehicles (%)	6%	6%	6%	16%	16%	16%	6%	6%	6%	62%	62%	62%
Adj. Flow (vph)	43	1025	6	17	1112	79	18	6	65	177	5	27
Shared Lane Traffic (%)												
Lane Group Flow (vph)	43	1031	0	17	1191	0	0	89	0	0	182	27
Enter Blocked Intersection	No	No	No	No	No	No	No	No	No	No	No	No
Lane Alignment	Left	Left	Right	Left	Left	Right	Left	Left	Right	Left	Left	Right
Median Width(ft)		12			12			0				0
Link Offset(ft)		0			0			0				0
Crosswalk Width(ft)		16			16			16				16
Two way Left Turn Lane												
Headway Factor	1.00	1.00	1.00	1.00	1.00	1.00	1.00	1.00	1.00	1.00	1.00	1.00
Turning Speed (mph)	15		9	15		9	15		9	15		9
Number of Detectors	1	2		1	2		1	2		1	2	1
Detector Template	Left	Thru		Left	Thru		Left	Thru		Left	Thru	Right
Leading Detector (ft)	20	100		20	100		20	100		20	100	20
Trailing Detector (ft)	0	0		0	0		0	0		0	0	0
Detector 1 Position(ft)	0	0		0	0		0	0		0	0	0
Detector 1 Size(ft)	20	6		20	6		20	6		20	6	20
Detector 1 Type	Cl+Ex	Cl+Ex		Cl+Ex	Cl+Ex		Cl+Ex	Cl+Ex		Cl+Ex	Cl+Ex	Cl+Ex
Detector 1 Channel												
Detector 1 Extend (s)	0.0	0.0		0.0	0.0		0.0	0.0		0.0	0.0	0.0
Detector 1 Queue (s)	0.0	0.0		0.0	0.0		0.0	0.0		0.0	0.0	0.0
Detector 1 Delay (s)	0.0	0.0		0.0	0.0		0.0	0.0		0.0	0.0	0.0
Detector 2 Position(ft)		94			94			94				94
Detector 2 Size(ft)		6			6			6				6
Detector 2 Type		Cl+Ex			Cl+Ex			Cl+Ex				Cl+Ex
Detector 2 Channel												
Detector 2 Extend (s)		0.0			0.0			0.0				0.0
Turn Type	Prot	NA		Prot	NA		Perm	NA		Perm	NA	Perm
Protected Phases	1	6		5	2			4				8

Lanes, Volumes, Timings
5: 6th & Brownell

11/08/2022



Lane Group	EBL	EBT	EBR	WBL	WBT	WBR	NBL	NBT	NBR	SBL	SBT	SBR
Permitted Phases							4			8		8
Detector Phase	1	6		5	2		4	4		8	8	8
Switch Phase												
Minimum Initial (s)	7.0	10.0		7.0	10.0		7.0	7.0		7.0	7.0	7.0
Minimum Split (s)	13.0	40.5		13.0	36.5		36.5	36.5		37.0	37.0	37.0
Total Split (s)	13.0	45.0		13.0	45.0		37.0	37.0		37.0	37.0	37.0
Total Split (%)	13.7%	47.4%		13.7%	47.4%		38.9%	38.9%		38.9%	38.9%	38.9%
Maximum Green (s)	8.5	40.5		8.5	40.5		32.5	32.5		32.5	32.5	32.5
Yellow Time (s)	4.0	4.0		4.0	4.0		4.0	4.0		4.0	4.0	4.0
All-Red Time (s)	0.5	0.5		0.5	0.5		0.5	0.5		0.5	0.5	0.5
Lost Time Adjust (s)	0.0	0.0		0.0	0.0			0.0			0.0	0.0
Total Lost Time (s)	4.5	4.5		4.5	4.5			4.5			4.5	4.5
Lead/Lag	Lead	Lag		Lead	Lag							
Lead-Lag Optimize?	Yes	Yes		Yes	Yes							
Vehicle Extension (s)	3.5	5.6		3.5	4.6		3.5	3.5		5.0	5.0	5.0
Minimum Gap (s)	2.0	3.6		2.0	2.6		2.0	2.0		5.0	5.0	5.0
Time Before Reduce (s)	10.0	10.0		10.0	10.0		15.0	15.0		5.0	5.0	5.0
Time To Reduce (s)	10.0	10.0		10.0	10.0		15.0	15.0		5.0	5.0	5.0
Recall Mode	None	Min		None	Min		None	None		None	None	None
Walk Time (s)		7.0			7.0		7.0	7.0		7.0	7.0	7.0
Flash Dont Walk (s)		29.0			22.0		23.0	23.0		25.0	25.0	25.0
Pedestrian Calls (#/hr)		0			0		0	0		0	0	0
Act Effct Green (s)	7.9	40.8		8.3	43.3			31.2			31.2	31.2
Actuated g/C Ratio	0.09	0.45		0.09	0.48			0.34			0.34	0.34
v/c Ratio	0.29	0.68		0.12	0.81			0.16			0.65	0.07
Control Delay	46.2	23.8		51.7	21.5			9.4			39.1	0.4
Queue Delay	0.0	0.5		0.0	0.0			0.0			0.0	0.0
Total Delay	46.2	24.3		51.7	21.5			9.4			39.1	0.4
LOS	D	C		D	C			A			D	A
Approach Delay		25.2			21.9			9.4			34.1	
Approach LOS		C			C			A			C	
Queue Length 50th (ft)	25	262		11	356			10			92	0
Queue Length 95th (ft)	52	287		m21	#476			38			#186	1
Internal Link Dist (ft)		998			156			168			380	
Turn Bay Length (ft)	165											
Base Capacity (vph)	160	1524		146	1471			583			293	402
Starvation Cap Reductn	0	0		0	0			0			0	0
Spillback Cap Reductn	0	161		0	0			2			0	0
Storage Cap Reductn	0	0		0	0			0			0	0
Reduced v/c Ratio	0.27	0.76		0.12	0.81			0.15			0.62	0.07

Intersection Summary

Area Type:	Other
Cycle Length:	95
Actuated Cycle Length:	91.1
Natural Cycle:	95
Control Type:	Actuated-Uncoordinated
Maximum v/c Ratio:	0.90
Intersection Signal Delay:	23.8
Intersection LOS:	C

Lanes, Volumes, Timings

5: 6th & Brownell

11/08/2022

Intersection Capacity Utilization 53.2% ICU Level of Service A

Analysis Period (min) 15

95th percentile volume exceeds capacity, queue may be longer.

Queue shown is maximum after two cycles.

















m Volume for 95th percentile queue is metered by upstream signal.

Splits and Phases: 5: 6th & Brownell



Lanes, Volumes, Timings
6: I-82 SB Entrance Ramp/I-82 SB Exit Ramp & 6th

11/08/2022

												
Lane Group	EBL	EBT	EBR	WBL	WBT	WBR	NBL	NBT	NBR	SBL	SBT	SBR
Lane Configurations												
Traffic Volume (vph)	0	900	150	90	610	0	0	0	0	425	5	465
Future Volume (vph)	0	900	150	90	610	0	0	0	0	425	5	465
Ideal Flow (vphpl)	1900	1900	1900	1900	1900	1900	1900	1900	1900	1900	1900	1900
Storage Length (ft)	0		0	110		0	0		0	0		0
Storage Lanes	0		0	1		0	0		0	0		1
Taper Length (ft)	25			45			25			25		
Lane Util. Factor	1.00	0.95	0.95	1.00	0.95	1.00	1.00	1.00	1.00	1.00	1.00	1.00
Frt		0.979										0.850
Flt Protected				0.950							0.953	
Satd. Flow (prot)	0	3047	0	1687	3374	0	0	0	0	0	1548	1380
Flt Permitted				0.950							0.953	
Satd. Flow (perm)	0	3047	0	1687	3374	0	0	0	0	0	1548	1380
Right Turn on Red			Yes			Yes			Yes			Yes
Satd. Flow (RTOR)		25										303
Link Speed (mph)		35			35			45				45
Link Distance (ft)		236			481			189				496
Travel Time (s)		4.6			9.4			2.9				7.5
Peak Hour Factor	0.85	0.85	0.85	0.91	0.91	0.91	0.92	0.92	0.92	0.93	0.93	0.93
Heavy Vehicles (%)	16%	16%	16%	7%	7%	7%	2%	2%	2%	17%	17%	17%
Adj. Flow (vph)	0	1059	176	99	670	0	0	0	0	457	5	500
Shared Lane Traffic (%)												
Lane Group Flow (vph)	0	1235	0	99	670	0	0	0	0	0	462	500
Enter Blocked Intersection	No	No	No	No	No	No	No	No	No	No	No	No
Lane Alignment	Left	Right	Right	Left	Right	R NA	Left	Left	Right	Left	Left	Right
Median Width(ft)		12			12			0				0
Link Offset(ft)		0			0			0				0
Crosswalk Width(ft)		16			16			16				16
Two way Left Turn Lane												
Headway Factor	1.00	1.00	1.00	1.00	1.00	1.00	1.00	1.00	1.00	1.00	1.00	1.00
Turning Speed (mph)	15		9	15		9	15		9	15		9
Number of Detectors		2		1	2					1	2	1
Detector Template		Thru		Left	Thru					Left	Thru	Right
Leading Detector (ft)		100		20	100					20	100	20
Trailing Detector (ft)		0		0	0					0	0	0
Detector 1 Position(ft)		0		0	0					0	0	0
Detector 1 Size(ft)		6		20	6					20	6	20
Detector 1 Type		Cl+Ex		Cl+Ex	Cl+Ex					Cl+Ex	Cl+Ex	Cl+Ex
Detector 1 Channel												
Detector 1 Extend (s)		0.0		0.0	0.0					0.0	0.0	0.0
Detector 1 Queue (s)		0.0		0.0	0.0					0.0	0.0	0.0
Detector 1 Delay (s)		0.0		0.0	0.0					0.0	0.0	0.0
Detector 2 Position(ft)		94			94							94
Detector 2 Size(ft)		6			6							6
Detector 2 Type		Cl+Ex			Cl+Ex							Cl+Ex
Detector 2 Channel												
Detector 2 Extend (s)		0.0			0.0							0.0
Turn Type		NA		Prot	NA					Perm	NA	Perm
Protected Phases		6		5	2							8

Lane Group	Ø1	Ø4
Lane Configurations		
Traffic Volume (vph)		
Future Volume (vph)		
Ideal Flow (vphpl)		
Storage Length (ft)		
Storage Lanes		
Taper Length (ft)		
Lane Util. Factor		
Frt		
Flt Protected		
Satd. Flow (prot)		
Flt Permitted		
Satd. Flow (perm)		
Right Turn on Red		
Satd. Flow (RTOR)		
Link Speed (mph)		
Link Distance (ft)		
Travel Time (s)		
Peak Hour Factor		
Heavy Vehicles (%)		
Adj. Flow (vph)		
Shared Lane Traffic (%)		
Lane Group Flow (vph)		
Enter Blocked Intersection		
Lane Alignment		
Median Width(ft)		
Link Offset(ft)		
Crosswalk Width(ft)		
Two way Left Turn Lane		
Headway Factor		
Turning Speed (mph)		
Number of Detectors		
Detector Template		
Leading Detector (ft)		
Trailing Detector (ft)		
Detector 1 Position(ft)		
Detector 1 Size(ft)		
Detector 1 Type		
Detector 1 Channel		
Detector 1 Extend (s)		
Detector 1 Queue (s)		
Detector 1 Delay (s)		
Detector 2 Position(ft)		
Detector 2 Size(ft)		
Detector 2 Type		
Detector 2 Channel		
Detector 2 Extend (s)		
Turn Type		
Protected Phases	1	4

Lanes, Volumes, Timings
6: I-82 SB Entrance Ramp/I-82 SB Exit Ramp & 6th

11/08/2022



Lane Group	EBL	EBT	EBR	WBL	WBT	WBR	NBL	NBT	NBR	SBL	SBT	SBR
Permitted Phases										8		8
Detector Phase		6		5	2					8	8	8
Switch Phase												
Minimum Initial (s)		10.0		7.0	10.0					7.0	7.0	7.0
Minimum Split (s)		40.5		13.0	36.5					37.0	37.0	37.0
Total Split (s)		45.0		13.0	45.0					37.0	37.0	37.0
Total Split (%)		47.4%		13.7%	47.4%					38.9%	38.9%	38.9%
Maximum Green (s)		40.5		8.5	40.5					32.5	32.5	32.5
Yellow Time (s)		4.0		4.0	4.0					4.0	4.0	4.0
All-Red Time (s)		0.5		0.5	0.5					0.5	0.5	0.5
Lost Time Adjust (s)		0.0		0.0	0.0						0.0	0.0
Total Lost Time (s)		4.5		4.5	4.5						4.5	4.5
Lead/Lag		Lag		Lead	Lag							
Lead-Lag Optimize?		Yes		Yes	Yes							
Vehicle Extension (s)		5.6		3.5	4.6					5.0	5.0	5.0
Minimum Gap (s)		3.6		2.0	2.6					5.0	5.0	5.0
Time Before Reduce (s)		10.0		10.0	10.0					5.0	5.0	5.0
Time To Reduce (s)		10.0		10.0	10.0					5.0	5.0	5.0
Recall Mode		Min		None	Min					None	None	None
Walk Time (s)		7.0			7.0					7.0	7.0	7.0
Flash Dont Walk (s)		29.0			22.0					25.0	25.0	25.0
Pedestrian Calls (#/hr)		0			0					0	0	0
Act Effct Green (s)		40.8		8.3	43.3						31.2	31.2
Actuated g/C Ratio		0.45		0.09	0.48						0.34	0.34
v/c Ratio		0.90		0.65	0.42						0.87	0.74
Control Delay		19.6		62.8	18.0						47.8	18.2
Queue Delay		0.0		0.0	0.1						0.0	0.7
Total Delay		19.6		62.8	18.1						47.8	19.0
LOS		B		E	B						D	B
Approach Delay		19.6			23.9						32.8	
Approach LOS		B			C						C	
Queue Length 50th (ft)		87		59	147						258	101
Queue Length 95th (ft)		#455		#132	197						#439	236
Internal Link Dist (ft)		156			401			109			416	
Turn Bay Length (ft)				110								
Base Capacity (vph)		1379		158	1605						556	690
Starvation Cap Reductn		1		0	0						0	0
Spillback Cap Reductn		0		0	210						0	43
Storage Cap Reductn		0		0	0						0	0
Reduced v/c Ratio		0.90		0.63	0.48						0.83	0.77

Intersection Summary

Area Type:	Other
Cycle Length:	95
Actuated Cycle Length:	91.1
Natural Cycle:	95
Control Type:	Actuated-Uncoordinated
Maximum v/c Ratio:	0.90
Intersection Signal Delay:	25.0
Intersection LOS:	C

Lanes, Volumes, Timings
 6: I-82 SB Entrance Ramp/I-82 SB Exit Ramp & 6th

11/08/2022

Lane Group	Ø1	Ø4
Permitted Phases		
Detector Phase		
Switch Phase		
Minimum Initial (s)	7.0	7.0
Minimum Split (s)	13.0	36.5
Total Split (s)	13.0	37.0
Total Split (%)	14%	39%
Maximum Green (s)	8.5	32.5
Yellow Time (s)	4.0	4.0
All-Red Time (s)	0.5	0.5
Lost Time Adjust (s)		
Total Lost Time (s)		
Lead/Lag	Lead	
Lead-Lag Optimize?	Yes	
Vehicle Extension (s)	3.5	3.5
Minimum Gap (s)	2.0	2.0
Time Before Reduce (s)	10.0	15.0
Time To Reduce (s)	10.0	15.0
Recall Mode	None	None
Walk Time (s)		7.0
Flash Dont Walk (s)		23.0
Pedestrian Calls (#/hr)		0
Act Effct Green (s)		
Actuated g/C Ratio		
v/c Ratio		
Control Delay		
Queue Delay		
Total Delay		
LOS		
Approach Delay		
Approach LOS		
Queue Length 50th (ft)		
Queue Length 95th (ft)		
Internal Link Dist (ft)		
Turn Bay Length (ft)		
Base Capacity (vph)		
Starvation Cap Reductn		
Spillback Cap Reductn		
Storage Cap Reductn		
Reduced v/c Ratio		
Intersection Summary		

Lanes, Volumes, Timings

6: I-82 SB Entrance Ramp/I-82 SB Exit Ramp & 6th

11/08/2022

Intersection Capacity Utilization 70.6% ICU Level of Service C

Analysis Period (min) 15

95th percentile volume exceeds capacity, queue may be longer.

Queue shown is maximum after two cycles.

Splits and Phases: 6: I-82 SB Entrance Ramp/I-82 SB Exit Ramp & 6th

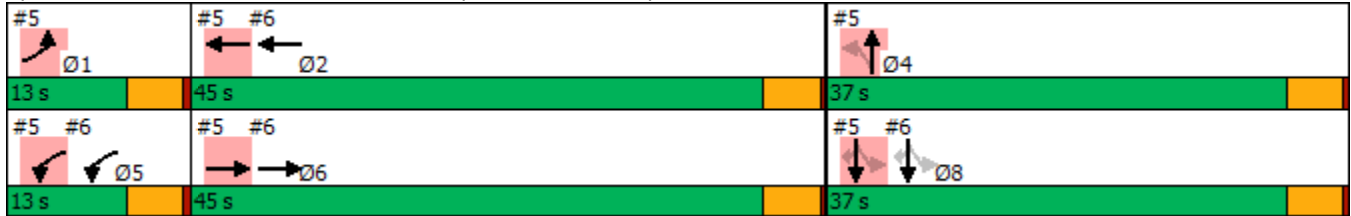

Lanes, Volumes, Timings

7: I-82 NB Exit Ramp/I-82 NB Entrance Ramp & 6th

11/08/2022

Lane Group	EBL	EBT	EBR	WBL	WBT	WBR	NBL	NBT	NBR	SBL	SBT	SBR
Lane Configurations												
Traffic Volume (vph)	415	910	0	0	660	645	40	5	170	0	0	0
Future Volume (vph)	415	910	0	0	660	645	40	5	170	0	0	0
Ideal Flow (vphpl)	1900	1900	1900	1900	1900	1900	1900	1900	1900	1900	1900	1900
Storage Length (ft)	110		0	0		250	0		215	0		0
Storage Lanes	1		0	0		1	0		1	0		0
Taper Length (ft)	70			25			25			25		
Lane Util. Factor	1.00	0.95	1.00	1.00	0.95	1.00	1.00	1.00	1.00	1.00	1.00	1.00
Frt						0.850			0.850			
Flt Protected	0.950							0.957				
Satd. Flow (prot)	1719	3438	0	0	3438	1538	0	1478	1313	0	0	0
Flt Permitted	0.173							0.957				
Satd. Flow (perm)	313	3438	0	0	3438	1538	0	1478	1313	0	0	0
Right Turn on Red			Yes			Yes			Yes			Yes
Satd. Flow (RTOR)						539			128			
Link Speed (mph)		35			45			45				45
Link Distance (ft)		481			3338			681				572
Travel Time (s)		9.4			50.6			10.3				8.7
Peak Hour Factor	0.80	0.80	0.80	0.85	0.85	0.85	0.82	0.82	0.82	0.92	0.92	0.92
Heavy Vehicles (%)	5%	5%	5%	5%	5%	5%	23%	23%	23%	2%	2%	2%
Adj. Flow (vph)	519	1138	0	0	776	759	49	6	207	0	0	0
Shared Lane Traffic (%)												
Lane Group Flow (vph)	519	1138	0	0	776	759	0	55	207	0	0	0
Enter Blocked Intersection	No	No	No	No	No	No	No	No	No	No	No	No
Lane Alignment	Left	Left	Right	Left	Left	Right	Left	Left	Right	Left	Left	Right
Median Width(ft)		12			12			0				0
Link Offset(ft)		0			0			0				0
Crosswalk Width(ft)		16			16			16				16
Two way Left Turn Lane												
Headway Factor	1.00	1.00	1.00	1.00	1.00	1.00	1.00	1.00	1.00	1.00	1.00	1.00
Turning Speed (mph)	15		9	15		9	15		9	15		9
Number of Detectors	1	2			2	1	1	2	1			
Detector Template	Left	Thru			Thru	Right	Left	Thru	Right			
Leading Detector (ft)	20	100			100	20	20	100	20			
Trailing Detector (ft)	0	0			0	0	0	0	0			
Detector 1 Position(ft)	0	0			0	0	0	0	0			
Detector 1 Size(ft)	20	6			6	20	20	6	20			
Detector 1 Type	Cl+Ex	Cl+Ex			Cl+Ex	Cl+Ex	Cl+Ex	Cl+Ex	Cl+Ex			
Detector 1 Channel												
Detector 1 Extend (s)	0.0	0.0			0.0	0.0	0.0	0.0	0.0			
Detector 1 Queue (s)	0.0	0.0			0.0	0.0	0.0	0.0	0.0			
Detector 1 Delay (s)	0.0	0.0			0.0	0.0	0.0	0.0	0.0			
Detector 2 Position(ft)		94			94			94				
Detector 2 Size(ft)		6			6			6				
Detector 2 Type		Cl+Ex			Cl+Ex			Cl+Ex				
Detector 2 Channel												
Detector 2 Extend (s)		0.0			0.0			0.0				
Turn Type	pm+pt	NA			NA	Perm	Perm	NA	Perm			
Protected Phases	7	4			8			2				

Lanes, Volumes, Timings

7: I-82 NB Exit Ramp/I-82 NB Entrance Ramp & 6th

11/08/2022



Lane Group	EBL	EBT	EBR	WBL	WBT	WBR	NBL	NBT	NBR	SBL	SBT	SBR
Permitted Phases	4					8	2		2			
Detector Phase	7	4			8	8	2	2	2			
Switch Phase												
Minimum Initial (s)	5.0	5.0			5.0	5.0	5.0	5.0	5.0			
Minimum Split (s)	9.5	22.5			22.5	22.5	22.5	22.5	22.5			
Total Split (s)	30.6	71.0			40.4	40.4	24.0	24.0	24.0			
Total Split (%)	32.2%	74.7%			42.5%	42.5%	25.3%	25.3%	25.3%			
Maximum Green (s)	26.1	66.5			35.9	35.9	19.5	19.5	19.5			
Yellow Time (s)	3.5	3.5			3.5	3.5	3.5	3.5	3.5			
All-Red Time (s)	1.0	1.0			1.0	1.0	1.0	1.0	1.0			
Lost Time Adjust (s)	0.0	0.0			0.0	0.0		0.0	0.0			
Total Lost Time (s)	4.5	4.5			4.5	4.5		4.5	4.5			
Lead/Lag	Lead				Lag	Lag						
Lead-Lag Optimize?	Yes				Yes	Yes						
Vehicle Extension (s)	3.0	3.0			3.0	3.0	3.0	3.0	3.0			
Recall Mode	None	None			None	None	C-Max	C-Max	C-Max			
Walk Time (s)		7.0			7.0	7.0	7.0	7.0	7.0			
Flash Dont Walk (s)		11.0			11.0	11.0	11.0	11.0	11.0			
Pedestrian Calls (#/hr)		0			0	0	0	0	0			
Act Effct Green (s)	61.6	61.6			31.6	31.6		24.4	24.4			
Actuated g/C Ratio	0.65	0.65			0.33	0.33		0.26	0.26			
v/c Ratio	0.89	0.51			0.68	0.87		0.15	0.48			
Control Delay	38.7	9.3			30.1	20.1		31.6	17.6			
Queue Delay	0.0	0.5			0.0	0.0		0.0	0.0			
Total Delay	38.7	9.8			30.1	20.1		31.6	17.6			
LOS	D	A			C	C		C	B			
Approach Delay		18.9			25.2			20.5				
Approach LOS		B			C			C				
Queue Length 50th (ft)	208	158			205	125		27	39			
Queue Length 95th (ft)	268	148			236	245		56	93			
Internal Link Dist (ft)		401			3258			601			492	
Turn Bay Length (ft)	110					250			215			
Base Capacity (vph)	589	2406			1299	916		379	432			
Starvation Cap Reductn	0	721			0	0		0	0			
Spillback Cap Reductn	0	0			0	0		0	0			
Storage Cap Reductn	0	0			0	0		0	0			
Reduced v/c Ratio	0.88	0.68			0.60	0.83		0.15	0.48			

Intersection Summary

Area Type:	Other
Cycle Length:	95
Actuated Cycle Length:	95
Offset:	0 (0%), Referenced to phase 2:NBTL and 6:, Start of Green
Natural Cycle:	90
Control Type:	Actuated-Coordinated
Maximum v/c Ratio:	0.89
Intersection Signal Delay:	21.8
Intersection LOS:	C
Intersection Capacity Utilization:	78.3%
ICU Level of Service:	D
Analysis Period (min):	15

Lanes, Volumes, Timings

7: I-82 NB Exit Ramp/I-82 NB Entrance Ramp & 6th





















11/08/2022

Splits and Phases: 7: I-82 NB Exit Ramp/I-82 NB Entrance Ramp & 6th



Lanes, Volumes, Timings
8: Devore & 6th

11/08/2022

												
Lane Group	EBL	EBT	EBR	WBL	WBT	WBR	NBL	NBT	NBR	SBL	SBT	SBR
Lane Configurations												
Traffic Volume (vph)	10	380	0	420	690	10	625	15	335	10	20	55
Future Volume (vph)	10	380	0	420	690	10	625	15	335	10	20	55
Ideal Flow (vphpl)	1900	1900	1900	1900	1900	1900	1900	1900	1900	1900	1900	1900
Storage Length (ft)	125		0	145		0	0		0	0		0
Storage Lanes	1		0	1		0	1		1	0		0
Taper Length (ft)	60			88			25			25		
Lane Util. Factor	1.00	0.95	1.00	0.97	1.00	1.00	0.95	0.95	1.00	1.00	1.00	1.00
Frt					0.998				0.850		0.913	
Flt Protected	0.950			0.950			0.950	0.955			0.994	
Satd. Flow (prot)	1770	3539	0	3433	1859	0	1681	1690	1583	0	1690	0
Flt Permitted	0.950			0.950			0.950	0.955			0.994	
Satd. Flow (perm)	1770	3539	0	3433	1859	0	1681	1690	1583	0	1690	0
Right Turn on Red			Yes			Yes			Yes			Yes
Satd. Flow (RTOR)					1				372			58
Link Speed (mph)		45			45			45				45
Link Distance (ft)		343			889			455				382
Travel Time (s)		5.2			13.5			6.9				5.8
Peak Hour Factor	0.82	0.82	0.82	0.72	0.72	0.72	0.90	0.90	0.90	0.42	0.42	0.42
Adj. Flow (vph)	12	463	0	583	958	14	694	17	372	24	48	131
Shared Lane Traffic (%)							49%					
Lane Group Flow (vph)	12	463	0	583	972	0	354	357	372	0	203	0
Enter Blocked Intersection	No	No	No	No	No	No	No	No	No	No	No	No
Lane Alignment	Left	Left	Right	Left	Left	Right	Left	Left	Right	Left	Left	Right
Median Width(ft)		24			24			12				12
Link Offset(ft)		0			0			0				0
Crosswalk Width(ft)		16			16			16				16
Two way Left Turn Lane												
Headway Factor	1.00	1.00	1.00	1.00	1.00	1.00	1.00	1.00	1.00	1.00	1.00	1.00
Turning Speed (mph)	15		9	15		9	15		9	15		9
Number of Detectors	1	2		1	2		1	2	1	1		2
Detector Template	Left	Thru		Left	Thru		Left	Thru	Right	Left		Thru
Leading Detector (ft)	20	100		20	100		20	100	20	20		100
Trailing Detector (ft)	0	0		0	0		0	0	0	0		0
Detector 1 Position(ft)	0	0		0	0		0	0	0	0		0
Detector 1 Size(ft)	20	6		20	6		20	6	20	20		6
Detector 1 Type	Cl+Ex	Cl+Ex		Cl+Ex	Cl+Ex		Cl+Ex	Cl+Ex	Cl+Ex	Cl+Ex		Cl+Ex
Detector 1 Channel												
Detector 1 Extend (s)	0.0	0.0		0.0	0.0		0.0	0.0	0.0	0.0		0.0
Detector 1 Queue (s)	0.0	0.0		0.0	0.0		0.0	0.0	0.0	0.0		0.0
Detector 1 Delay (s)	0.0	0.0		0.0	0.0		0.0	0.0	0.0	0.0		0.0
Detector 2 Position(ft)		94			94			94				94
Detector 2 Size(ft)		6			6			6				6
Detector 2 Type		Cl+Ex			Cl+Ex			Cl+Ex				Cl+Ex
Detector 2 Channel												
Detector 2 Extend (s)		0.0			0.0			0.0				0.0
Turn Type	Prot	NA		Prot	NA		Split	NA	Perm	Split		NA
Protected Phases	5	2		1	6		8	8		4		4
Permitted Phases									8			

Lanes, Volumes, Timings

8: Devore & 6th

11/08/2022



Lane Group	EBL	EBT	EBR	WBL	WBT	WBR	NBL	NBT	NBR	SBL	SBT	SBR
Detector Phase	5	2		1	6		8	8	8	4	4	
Switch Phase												
Minimum Initial (s)	8.0	10.0		8.0	10.0		8.0	8.0	8.0	7.0	7.0	
Minimum Split (s)	13.0	36.5		13.0	31.5		46.5	46.5	46.5	36.5	36.5	
Total Split (s)	13.0	45.0		17.0	49.0		46.5	46.5	46.5	36.5	36.5	
Total Split (%)	9.0%	31.0%		11.7%	33.8%		32.1%	32.1%	32.1%	25.2%	25.2%	
Maximum Green (s)	8.5	39.5		12.5	43.5		41.0	41.0	41.0	32.0	32.0	
Yellow Time (s)	4.0	5.0		4.0	5.0		5.0	5.0	5.0	4.0	4.0	
All-Red Time (s)	0.5	0.5		0.5	0.5		0.5	0.5	0.5	0.5	0.5	
Lost Time Adjust (s)	0.0	0.0		0.0	0.0		0.0	0.0	0.0		0.0	
Total Lost Time (s)	4.5	5.5		4.5	5.5		5.5	5.5	5.5		4.5	
Lead/Lag	Lead	Lag		Lead	Lag							
Lead-Lag Optimize?	Yes	Yes		Yes	Yes							
Vehicle Extension (s)	2.5	7.0		3.5	5.4		3.5	3.5	3.5	2.5	2.5	
Minimum Gap (s)	1.0	3.4		2.5	3.4		1.5	1.5	1.5	1.0	1.0	
Time Before Reduce (s)	5.0	15.0		5.0	15.0		10.0	10.0	10.0	5.0	5.0	
Time To Reduce (s)	5.0	15.0		5.0	15.0		10.0	10.0	10.0	5.0	5.0	
Recall Mode	None	Min		None	Min		None	None	None	None	None	
Walk Time (s)		7.0			7.0		7.0	7.0	7.0	7.0	7.0	
Flash Dont Walk (s)		24.0			19.0		34.0	34.0	34.0	25.0	25.0	
Pedestrian Calls (#/hr)		0			0		0	0	0	0	0	
Act Effct Green (s)	8.3	31.5		12.9	45.0		28.9	28.9	28.9		15.0	
Actuated g/C Ratio	0.08	0.29		0.12	0.41		0.27	0.27	0.27		0.14	
v/c Ratio	0.09	0.45		1.43	1.27		0.80	0.80	0.54		0.72	
Control Delay	58.2	35.0		243.7	160.1		52.5	52.6	6.6		48.5	
Queue Delay	0.0	0.0		0.0	0.0		0.0	0.0	0.0		0.0	
Total Delay	58.2	35.0		243.7	160.1		52.5	52.6	6.6		48.5	
LOS	E	D		F	F		D	D	A		D	
Approach Delay		35.6			191.5			36.8			48.5	
Approach LOS		D			F			D			D	
Queue Length 50th (ft)	7	133		~258	~777		221	223	0		90	
Queue Length 95th (ft)	30	208		#390	#1103		418	420	76		61	
Internal Link Dist (ft)		263			809			375			302	
Turn Bay Length (ft)	125			145								
Base Capacity (vph)	142	1327		407	768		654	657	843		553	
Starvation Cap Reductn	0	0		0	0		0	0	0		0	
Spillback Cap Reductn	0	0		0	0		0	0	0		0	
Storage Cap Reductn	0	0		0	0		0	0	0		0	
Reduced v/c Ratio	0.08	0.35		1.43	1.27		0.54	0.54	0.44		0.37	

Intersection Summary

Area Type:	Other
Cycle Length:	145
Actuated Cycle Length:	109
Natural Cycle:	145
Control Type:	Actuated-Uncoordinated
Maximum v/c Ratio:	1.43
Intersection Signal Delay:	109.9
Intersection Capacity Utilization:	80.9%
Intersection LOS:	F
ICU Level of Service:	D

Lanes, Volumes, Timings

8: Devore & 6th

11/08/2022

Analysis Period (min) 15

~ Volume exceeds capacity, queue is theoretically infinite.

Queue shown is maximum after two cycles.

95th percentile volume exceeds capacity, queue may be longer.

Queue shown is maximum after two cycles.

Splits and Phases: 8: Devore & 6th

↙ Ø1	→ Ø2	↘ Ø4	↖ Ø8
17 s	45 s	36.5 s	46.5 s
↗ Ø5	← Ø6		
13 s	49 s		

Lanes, Volumes, Timings

12: 6th

11/08/2022

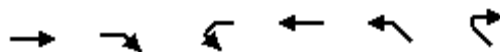

Lane Group	EBT	EBR	WBL	WBT	NWL	NWR
Lane Configurations	↑↑			↑↑		
Traffic Volume (vph)	390	610	0	1370	0	0
Future Volume (vph)	390	610	0	1370	0	0
Ideal Flow (vphpl)	1900	1900	1900	1900	1900	1900
Lane Util. Factor	0.95	0.95	1.00	0.95	1.00	1.00
Frt	0.909					
Flt Protected						
Satd. Flow (prot)	3011	0	0	3438	0	0
Flt Permitted						
Satd. Flow (perm)	3011	0	0	3438	0	0
Link Speed (mph)	45			45	45	
Link Distance (ft)	3338			343	639	
Travel Time (s)	50.6			5.2	9.7	
Peak Hour Factor	0.82	0.82	0.72	0.72	0.92	0.92
Heavy Vehicles (%)	9%	9%	5%	5%	2%	2%
Adj. Flow (vph)	476	744	0	1903	0	0
Shared Lane Traffic (%)						
Lane Group Flow (vph)	1220	0	0	1903	0	0
Enter Blocked Intersection	No	No	No	No	No	No
Lane Alignment	Left	Right	Left	Left	Left	Right
Median Width(ft)	12			12	0	
Link Offset(ft)	0			0	0	
Crosswalk Width(ft)	16			16	16	
Two way Left Turn Lane						
Headway Factor	1.00	1.00	1.00	1.00	1.00	1.00
Turning Speed (mph)	9		15	15		9
Sign Control	Free			Free	Free	







Intersection Summary

Area Type:	Other
Control Type:	Unsignalized
Intersection Capacity Utilization	41.2% ICU Level of Service A
Analysis Period (min)	15

Lanes, Volumes, Timings

13: Devore

11/08/2022

						
Lane Group	NBL	NBT	SBT	SBR	SEL	SER
Lane Configurations		↑↑	↑			↗
Traffic Volume (vph)	0	649	232	0	0	397
Future Volume (vph)	0	649	232	0	0	397
Ideal Flow (vphpl)	1900	1900	1900	1900	1900	1900
Lane Util. Factor	1.00	0.95	1.00	1.00	1.00	1.00
Fr _t						0.865
Fl _t Protected						
Satd. Flow (prot)	0	3471	1827	0	0	1508
Fl _t Permitted						
Satd. Flow (perm)	0	3471	1827	0	0	1508
Link Speed (mph)		45	45		45	
Link Distance (ft)		235	455		639	
Travel Time (s)		3.6	6.9		9.7	
Peak Hour Factor	0.90	0.90	0.92	0.92	0.82	0.82
Heavy Vehicles (%)	4%	4%	4%	4%	9%	9%
Adj. Flow (vph)	0	721	252	0	0	484
Shared Lane Traffic (%)						
Lane Group Flow (vph)	0	721	252	0	0	484
Enter Blocked Intersection	No	No	No	No	No	No
Lane Alignment	Left	Left	L NA	Right	Left	R NA
Median Width(ft)		0	0		0	
Link Offset(ft)		0	0		0	
Crosswalk Width(ft)		16	16		16	
Two way Left Turn Lane						
Headway Factor	1.00	1.00	1.00	1.00	1.00	1.00
Turning Speed (mph)	15			9	15	9
Sign Control		Free	Free		Free	
Intersection Summary						
Area Type:	Other					
Control Type:	Unsignalized					
Intersection Capacity Utilization	43.5%			ICU Level of Service A		
Analysis Period (min)	15					

Lanes, Volumes, Timings
2: Powerline & Hwy 730

11/08/2022



Lane Group	EBT	EBR	WBL	WBT	NBL	NBR
Lane Configurations	↑	↑	↑	↑	↑	↑
Traffic Volume (vph)	455	230	475	390	240	345
Future Volume (vph)	455	230	475	390	240	345
Ideal Flow (vphpl)	1900	1900	1900	1900	1900	1900
Storage Length (ft)		100	180		0	150
Storage Lanes		1	1		1	1
Taper Length (ft)			100		25	
Lane Util. Factor	1.00	1.00	1.00	1.00	1.00	1.00
Frt		0.850				0.850
Flt Protected			0.950		0.950	
Satd. Flow (prot)	1863	1583	1770	1863	1770	1583
Flt Permitted			0.142		0.950	
Satd. Flow (perm)	1863	1583	265	1863	1770	1583
Right Turn on Red		Yes				Yes
Satd. Flow (RTOR)		164				375
Link Speed (mph)	40			40	35	
Link Distance (ft)	728			823	449	
Travel Time (s)	12.4			14.0	8.7	
Peak Hour Factor	0.92	0.92	0.92	0.92	0.92	0.92
Adj. Flow (vph)	495	250	516	424	261	375
Shared Lane Traffic (%)						
Lane Group Flow (vph)	495	250	516	424	261	375
Enter Blocked Intersection	No	No	No	No	No	No
Lane Alignment	Left	Right	Left	Left	Left	Right
Median Width(ft)	12			12	12	
Link Offset(ft)	0			0	0	
Crosswalk Width(ft)	16			16	16	
Two way Left Turn Lane						
Headway Factor	1.00	1.00	1.00	1.00	1.00	1.00
Turning Speed (mph)		9	15		15	9
Number of Detectors	2	1	1	2	1	1
Detector Template	Thru	Right	Left	Thru	Left	Right
Leading Detector (ft)	100	20	20	100	20	20
Trailing Detector (ft)	0	0	0	0	0	0
Detector 1 Position(ft)	0	0	0	0	0	0
Detector 1 Size(ft)	6	20	20	6	20	20
Detector 1 Type	Cl+Ex	Cl+Ex	Cl+Ex	Cl+Ex	Cl+Ex	Cl+Ex
Detector 1 Channel						
Detector 1 Extend (s)	0.0	0.0	0.0	0.0	0.0	0.0
Detector 1 Queue (s)	0.0	0.0	0.0	0.0	0.0	0.0
Detector 1 Delay (s)	0.0	0.0	0.0	0.0	0.0	0.0
Detector 2 Position(ft)	94			94		
Detector 2 Size(ft)	6			6		
Detector 2 Type	Cl+Ex			Cl+Ex		
Detector 2 Channel						
Detector 2 Extend (s)	0.0			0.0		
Turn Type	NA	Perm	pm+pt	NA	Prot	Perm
Protected Phases	4		3	8	2	
Permitted Phases		4	8			2

Lanes, Volumes, Timings
2: Powerline & Hwy 730

11/08/2022



Lane Group	EBT	EBR	WBL	WBT	NBL	NBR
Detector Phase	4	4	3	8	2	2
Switch Phase						
Minimum Initial (s)	5.0	5.0	5.0	5.0	5.0	5.0
Minimum Split (s)	22.5	22.5	9.5	22.5	22.5	22.5
Total Split (s)	29.0	29.0	26.0	55.0	25.0	25.0
Total Split (%)	36.3%	36.3%	32.5%	68.8%	31.3%	31.3%
Maximum Green (s)	24.5	24.5	21.5	50.5	20.5	20.5
Yellow Time (s)	3.5	3.5	3.5	3.5	3.5	3.5
All-Red Time (s)	1.0	1.0	1.0	1.0	1.0	1.0
Lost Time Adjust (s)	0.0	0.0	0.0	0.0	0.0	0.0
Total Lost Time (s)	4.5	4.5	4.5	4.5	4.5	4.5
Lead/Lag	Lag	Lag	Lead			
Lead-Lag Optimize?	Yes	Yes	Yes			
Vehicle Extension (s)	3.0	3.0	3.0	3.0	3.0	3.0
Recall Mode	None	None	None	None	C-Max	C-Max
Walk Time (s)	7.0	7.0		7.0	7.0	7.0
Flash Dont Walk (s)	11.0	11.0		11.0	11.0	11.0
Pedestrian Calls (#/hr)	0	0		0	0	0
Act Effct Green (s)	23.6	23.6	49.0	49.0	22.0	22.0
Actuated g/C Ratio	0.30	0.30	0.61	0.61	0.28	0.28
v/c Ratio	0.90	0.43	0.93	0.37	0.54	0.53
Control Delay	49.0	10.7	44.6	8.6	30.3	6.0
Queue Delay	0.0	0.0	0.0	0.0	0.0	0.0
Total Delay	49.0	10.7	44.6	8.6	30.3	6.0
LOS	D	B	D	A	C	A
Approach Delay	36.1			28.4	16.0	
Approach LOS	D			C	B	
Queue Length 50th (ft)	232	31	190	90	114	0
Queue Length 95th (ft)	#403	90	#377	140	189	64
Internal Link Dist (ft)	648			743	369	
Turn Bay Length (ft)		100	180			150
Base Capacity (vph)	570	598	566	1176	486	706
Starvation Cap Reductn	0	0	0	0	0	0
Spillback Cap Reductn	0	0	0	0	0	0
Storage Cap Reductn	0	0	0	0	0	0
Reduced v/c Ratio	0.87	0.42	0.91	0.36	0.54	0.53

Intersection Summary

Area Type: Other
 Cycle Length: 80
 Actuated Cycle Length: 80
 Offset: 0 (0%), Referenced to phase 2:NBL and 6:, Start of Green
 Natural Cycle: 80
 Control Type: Actuated-Coordinated
 Maximum v/c Ratio: 0.93
 Intersection Signal Delay: 27.5
 Intersection LOS: C
 Intersection Capacity Utilization 74.8%
 ICU Level of Service D
 Analysis Period (min) 15
 # 95th percentile volume exceeds capacity, queue may be longer.

Lanes, Volumes, Timings
 2: Powerline & Hwy 730

11/08/2022

Queue shown is maximum after two cycles.

Splits and Phases: 2: Powerline & Hwy 730



Lanes, Volumes, Timings

4:

11/08/2022

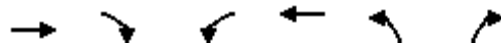

Lane Group	EBT	EBR	WBL	WBT	NBL	NBR
Lane Configurations	↑	↗	↖	↑	↘	↗
Traffic Volume (vph)	665	210	145	750	185	125
Future Volume (vph)	665	210	145	750	185	125
Ideal Flow (vphpl)	1900	1900	1900	1900	1900	1900
Storage Length (ft)		127	150		0	30
Storage Lanes		1	1		1	1
Taper Length (ft)			75		25	
Lane Util. Factor	1.00	1.00	1.00	1.00	1.00	1.00
Frt		0.850				0.850
Flt Protected			0.950		0.950	
Satd. Flow (prot)	1863	1583	1770	1863	1770	1583
Flt Permitted			0.127		0.950	
Satd. Flow (perm)	1863	1583	237	1863	1770	1583
Right Turn on Red		Yes				Yes
Satd. Flow (RTOR)		184				116
Link Speed (mph)	45			45	45	
Link Distance (ft)	1042			902	649	
Travel Time (s)	15.8			13.7	9.8	
Peak Hour Factor	0.92	0.92	0.92	0.92	0.92	0.92
Adj. Flow (vph)	723	228	158	815	201	136
Shared Lane Traffic (%)						
Lane Group Flow (vph)	723	228	158	815	201	136
Enter Blocked Intersection	No	No	No	No	No	No
Lane Alignment	Left	Right	Left	Left	Left	Right
Median Width(ft)	12			12	12	
Link Offset(ft)	0			0	0	
Crosswalk Width(ft)	16			16	16	
Two way Left Turn Lane	Yes					
Headway Factor	1.00	1.00	1.00	1.00	1.00	1.00
Turning Speed (mph)		9	15		15	9
Number of Detectors	2	1	1	2	1	1
Detector Template	Thru	Right	Left	Thru	Left	Right
Leading Detector (ft)	100	20	20	100	20	20
Trailing Detector (ft)	0	0	0	0	0	0
Detector 1 Position(ft)	0	0	0	0	0	0
Detector 1 Size(ft)	6	20	20	6	20	20
Detector 1 Type	Cl+Ex	Cl+Ex	Cl+Ex	Cl+Ex	Cl+Ex	Cl+Ex
Detector 1 Channel						
Detector 1 Extend (s)	0.0	0.0	0.0	0.0	0.0	0.0
Detector 1 Queue (s)	0.0	0.0	0.0	0.0	0.0	0.0
Detector 1 Delay (s)	0.0	0.0	0.0	0.0	0.0	0.0
Detector 2 Position(ft)	94			94		
Detector 2 Size(ft)	6			6		
Detector 2 Type	Cl+Ex			Cl+Ex		
Detector 2 Channel						
Detector 2 Extend (s)	0.0			0.0		
Turn Type	NA	Perm	pm+pt	NA	Prot	Perm
Protected Phases	4		3	8	2	
Permitted Phases		4	8			2

Lanes, Volumes, Timings

4:

11/08/2022

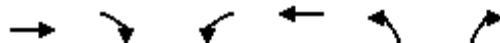

Lane Group	EBT	EBR	WBL	WBT	NBL	NBR
Detector Phase	4	4	3	8	2	2
Switch Phase						
Minimum Initial (s)	5.0	5.0	5.0	5.0	5.0	5.0
Minimum Split (s)	22.5	22.5	9.5	22.5	22.5	22.5
Total Split (s)	32.0	32.0	9.5	41.5	23.5	23.5
Total Split (%)	49.2%	49.2%	14.6%	63.8%	36.2%	36.2%
Maximum Green (s)	27.5	27.5	5.0	37.0	19.0	19.0
Yellow Time (s)	3.5	3.5	3.5	3.5	3.5	3.5
All-Red Time (s)	1.0	1.0	1.0	1.0	1.0	1.0
Lost Time Adjust (s)	0.0	0.0	0.0	0.0	0.0	0.0
Total Lost Time (s)	4.5	4.5	4.5	4.5	4.5	4.5
Lead/Lag	Lag	Lag	Lead			
Lead-Lag Optimize?	Yes	Yes	Yes			
Vehicle Extension (s)	3.0	3.0	3.0	3.0	3.0	3.0
Recall Mode	None	None	None	None	C-Max	C-Max
Walk Time (s)	7.0	7.0		7.0	7.0	7.0
Flash Dont Walk (s)	11.0	11.0		11.0	11.0	11.0
Pedestrian Calls (#/hr)	0	0		0	0	0
Act Effct Green (s)	26.9	26.9	36.4	36.4	19.6	19.6
Actuated g/C Ratio	0.41	0.41	0.56	0.56	0.30	0.30
v/c Ratio	0.94	0.30	0.63	0.78	0.38	0.24
Control Delay	41.1	4.6	20.6	17.8	20.8	6.6
Queue Delay	0.0	0.0	0.0	0.0	0.0	0.0
Total Delay	41.1	4.6	20.6	17.8	20.8	6.6
LOS	D	A	C	B	C	A
Approach Delay	32.4			18.3	15.1	
Approach LOS	C			B	B	
Queue Length 50th (ft)	259	10	27	222	63	6
Queue Length 95th (ft)	#469	47	#79	367	116	41
Internal Link Dist (ft)	962			822	569	
Turn Bay Length (ft)		127	150			30
Base Capacity (vph)	788	775	250	1060	534	559
Starvation Cap Reductn	0	0	0	0	0	0
Spillback Cap Reductn	0	0	0	0	0	0
Storage Cap Reductn	0	0	0	0	0	0
Reduced v/c Ratio	0.92	0.29	0.63	0.77	0.38	0.24

Intersection Summary

Area Type: Other
 Cycle Length: 65
 Actuated Cycle Length: 65
 Offset: 0 (0%), Referenced to phase 2:NBL and 6:, Start of Green
 Natural Cycle: 65
 Control Type: Actuated-Coordinated
 Maximum v/c Ratio: 0.94
 Intersection Signal Delay: 23.7
 Intersection LOS: C
 Intersection Capacity Utilization 64.5%
 ICU Level of Service C
 Analysis Period (min) 15
 # 95th percentile volume exceeds capacity, queue may be longer.

Lanes, Volumes, Timings

4:

11/08/2022





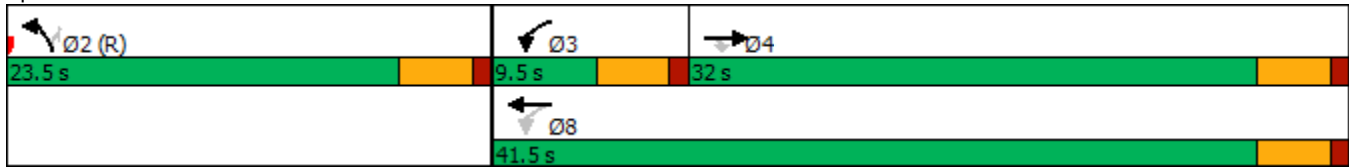













Queue shown is maximum after two cycles.

Splits and Phases: 4:



Lanes, Volumes, Timings
5: 6th & Brownell

11/08/2022

												
Lane Group	EBL	EBT	EBR	WBL	WBT	WBR	NBL	NBT	NBR	SBL	SBT	SBR
Lane Configurations												
Traffic Volume (vph)	35	830	5	15	990	70	15	5	55	165	5	25
Future Volume (vph)	35	830	5	15	990	70	15	5	55	165	5	25
Ideal Flow (vphpl)	1900	1900	1900	1900	1900	1900	1900	1900	1900	1900	1900	1900
Storage Length (ft)	165		0	0		0	0		0	0		0
Storage Lanes	1		0	1		0	0		0	0		1
Taper Length (ft)	135			25			25			25		
Lane Util. Factor	1.00	0.95	0.95	1.00	0.95	0.95	1.00	1.00	1.00	1.00	1.00	1.00
Frt		0.999			0.990			0.901				0.850
Flt Protected	0.950			0.950				0.990			0.954	
Satd. Flow (prot)	1703	3402	0	1556	3081	0	0	1599	0	0	1119	997
Flt Permitted	0.950			0.950				0.934			0.698	
Satd. Flow (perm)	1703	3402	0	1556	3081	0	0	1508	0	0	819	997
Right Turn on Red			Yes			Yes			Yes			Yes
Satd. Flow (RTOR)		1			10			65				69
Link Speed (mph)		35			35			30				30
Link Distance (ft)		1078			236			248				460
Travel Time (s)		21.0			4.6			5.6				10.5
Peak Hour Factor	0.81	0.81	0.81	0.89	0.89	0.89	0.84	0.84	0.84	0.93	0.93	0.93
Heavy Vehicles (%)	6%	6%	6%	16%	16%	16%	6%	6%	6%	62%	62%	62%
Adj. Flow (vph)	43	1025	6	17	1112	79	18	6	65	177	5	27
Shared Lane Traffic (%)												
Lane Group Flow (vph)	43	1031	0	17	1191	0	0	89	0	0	182	27
Enter Blocked Intersection	No	No	No	No	No	No	No	No	No	No	No	No
Lane Alignment	Left	Left	Right	Left	Left	Right	Left	Left	Right	Left	Left	Right
Median Width(ft)		12			12			0				0
Link Offset(ft)		0			0			0				0
Crosswalk Width(ft)		16			16			16				16
Two way Left Turn Lane												
Headway Factor	1.00	1.00	1.00	1.00	1.00	1.00	1.00	1.00	1.00	1.00	1.00	1.00
Turning Speed (mph)	15		9	15		9	15		9	15		9
Number of Detectors	1	2		1	2		1	2		1	2	1
Detector Template	Left	Thru		Left	Thru		Left	Thru		Left	Thru	Right
Leading Detector (ft)	20	100		20	100		20	100		20	100	20
Trailing Detector (ft)	0	0		0	0		0	0		0	0	0
Detector 1 Position(ft)	0	0		0	0		0	0		0	0	0
Detector 1 Size(ft)	20	6		20	6		20	6		20	6	20
Detector 1 Type	Cl+Ex	Cl+Ex		Cl+Ex	Cl+Ex		Cl+Ex	Cl+Ex		Cl+Ex	Cl+Ex	Cl+Ex
Detector 1 Channel												
Detector 1 Extend (s)	0.0	0.0		0.0	0.0		0.0	0.0		0.0	0.0	0.0
Detector 1 Queue (s)	0.0	0.0		0.0	0.0		0.0	0.0		0.0	0.0	0.0
Detector 1 Delay (s)	0.0	0.0		0.0	0.0		0.0	0.0		0.0	0.0	0.0
Detector 2 Position(ft)		94			94			94				94
Detector 2 Size(ft)		6			6			6				6
Detector 2 Type		Cl+Ex			Cl+Ex			Cl+Ex				Cl+Ex
Detector 2 Channel												
Detector 2 Extend (s)		0.0			0.0			0.0				0.0
Turn Type	Prot	NA		Prot	NA		Perm	NA		Perm	NA	Perm
Protected Phases	1	6		5	2			4				8

Lanes, Volumes, Timings
5: 6th & Brownell

11/08/2022



Lane Group	EBL	EBT	EBR	WBL	WBT	WBR	NBL	NBT	NBR	SBL	SBT	SBR
Permitted Phases							4			8		8
Detector Phase	1	6		5	2		4	4		8	8	8
Switch Phase												
Minimum Initial (s)	7.0	10.0		7.0	10.0		7.0	7.0		7.0	7.0	7.0
Minimum Split (s)	13.0	40.5		13.0	36.5		36.5	36.5		37.0	37.0	37.0
Total Split (s)	13.0	43.0		15.0	45.0		37.0	37.0		37.0	37.0	37.0
Total Split (%)	13.7%	45.3%		15.8%	47.4%		38.9%	38.9%		38.9%	38.9%	38.9%
Maximum Green (s)	8.5	38.5		10.5	40.5		32.5	32.5		32.5	32.5	32.5
Yellow Time (s)	4.0	4.0		4.0	4.0		4.0	4.0		4.0	4.0	4.0
All-Red Time (s)	0.5	0.5		0.5	0.5		0.5	0.5		0.5	0.5	0.5
Lost Time Adjust (s)	0.0	0.0		0.0	0.0			0.0			0.0	0.0
Total Lost Time (s)	4.5	4.5		4.5	4.5			4.5			4.5	4.5
Lead/Lag	Lead	Lag		Lead	Lag							
Lead-Lag Optimize?	Yes	Yes		Yes	Yes							
Vehicle Extension (s)	3.5	5.6		3.5	4.6		3.5	3.5		5.0	5.0	5.0
Minimum Gap (s)	2.0	3.6		2.0	2.6		2.0	2.0		5.0	5.0	5.0
Time Before Reduce (s)	10.0	10.0		10.0	10.0		15.0	15.0		5.0	5.0	5.0
Time To Reduce (s)	10.0	10.0		10.0	10.0		15.0	15.0		5.0	5.0	5.0
Recall Mode	None	Min		None	Min		None	None		None	None	None
Walk Time (s)		7.0			7.0		7.0	7.0		7.0	7.0	7.0
Flash Dont Walk (s)		29.0			22.0		23.0	23.0		25.0	25.0	25.0
Pedestrian Calls (#/hr)		0			0		0	0		0	0	0
Act Effct Green (s)	7.9	38.9		9.6	42.8			31.2			31.2	31.2
Actuated g/C Ratio	0.09	0.43		0.11	0.47			0.34			0.34	0.34
v/c Ratio	0.29	0.70		0.10	0.81			0.16			0.65	0.07
Control Delay	46.0	25.7		51.0	21.6			9.4			38.6	0.4
Queue Delay	0.0	0.7		0.0	0.0			0.0			0.0	0.0
Total Delay	46.0	26.3		51.0	21.6			9.4			38.6	0.4
LOS	D	C		D	C			A			D	A
Approach Delay		27.1			22.0			9.4			33.6	
Approach LOS		C			C			A			C	
Queue Length 50th (ft)	25	272		11	356			10			92	0
Queue Length 95th (ft)	52	299		m22	#476			38			#186	1
Internal Link Dist (ft)		998			156			168			380	
Turn Bay Length (ft)	165											
Base Capacity (vph)	161	1463		182	1479			588			297	405
Starvation Cap Reductn	0	0		0	0			0			0	0
Spillback Cap Reductn	0	164		0	0			2			0	0
Storage Cap Reductn	0	0		0	0			0			0	0
Reduced v/c Ratio	0.27	0.79		0.09	0.81			0.15			0.61	0.07

Intersection Summary

Area Type:	Other
Cycle Length:	95
Actuated Cycle Length:	90.5
Natural Cycle:	95
Control Type:	Actuated-Uncoordinated
Maximum v/c Ratio:	0.93
Intersection Signal Delay:	24.6
Intersection LOS:	C

Lanes, Volumes, Timings

5: 6th & Brownell

11/08/2022

Intersection Capacity Utilization 53.2% ICU Level of Service A

Analysis Period (min) 15

95th percentile volume exceeds capacity, queue may be longer.

Queue shown is maximum after two cycles.





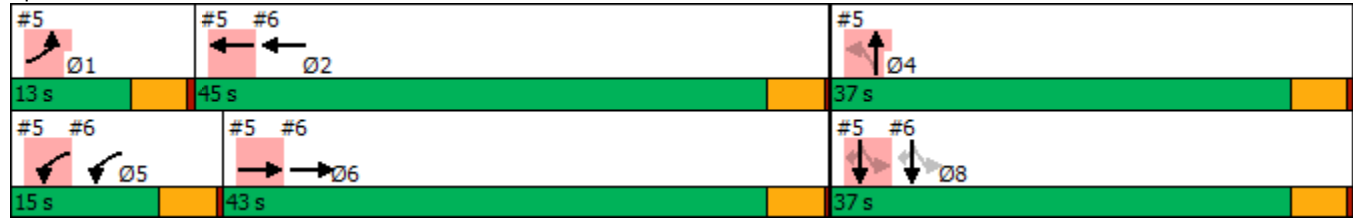











m Volume for 95th percentile queue is metered by upstream signal.

Splits and Phases: 5: 6th & Brownell



Lanes, Volumes, Timings
6: I-82 SB Entrance Ramp/I-82 SB Exit Ramp & 6th

11/08/2022

												
Lane Group	EBL	EBT	EBR	WBL	WBT	WBR	NBL	NBT	NBR	SBL	SBT	SBR
Lane Configurations												
Traffic Volume (vph)	0	900	150	90	610	0	0	0	0	425	5	465
Future Volume (vph)	0	900	150	90	610	0	0	0	0	425	5	465
Ideal Flow (vphpl)	1900	1900	1900	1900	1900	1900	1900	1900	1900	1900	1900	1900
Storage Length (ft)	0		0	125		0	0		0	0		0
Storage Lanes	0		0	1		0	0		0	0		1
Taper Length (ft)	25			45			25			25		
Lane Util. Factor	1.00	0.95	0.95	1.00	0.95	1.00	1.00	1.00	1.00	1.00	1.00	1.00
Frt		0.979										0.850
Flt Protected				0.950							0.953	
Satd. Flow (prot)	0	3047	0	1687	3374	0	0	0	0	0	1548	1380
Flt Permitted				0.950							0.953	
Satd. Flow (perm)	0	3047	0	1687	3374	0	0	0	0	0	1548	1380
Right Turn on Red			Yes			Yes			Yes			Yes
Satd. Flow (RTOR)		24										310
Link Speed (mph)		35			35			45				45
Link Distance (ft)		236			481			189				496
Travel Time (s)		4.6			9.4			2.9				7.5
Peak Hour Factor	0.85	0.85	0.85	0.91	0.91	0.91	0.92	0.92	0.92	0.93	0.93	0.93
Heavy Vehicles (%)	16%	16%	16%	7%	7%	7%	2%	2%	2%	17%	17%	17%
Adj. Flow (vph)	0	1059	176	99	670	0	0	0	0	457	5	500
Shared Lane Traffic (%)												
Lane Group Flow (vph)	0	1235	0	99	670	0	0	0	0	0	462	500
Enter Blocked Intersection	No	No	No	No	No	No	No	No	No	No	No	No
Lane Alignment	Left	Right	Right	Left	Right	R NA	Left	Left	Right	Left	Left	Right
Median Width(ft)		12			12			0				0
Link Offset(ft)		0			0			0				0
Crosswalk Width(ft)		16			16			16				16
Two way Left Turn Lane												
Headway Factor	1.00	1.00	1.00	1.00	1.00	1.00	1.00	1.00	1.00	1.00	1.00	1.00
Turning Speed (mph)	15		9	15		9	15		9	15		9
Number of Detectors		2		1	2					1	2	1
Detector Template		Thru		Left	Thru					Left	Thru	Right
Leading Detector (ft)		100		20	100					20	100	20
Trailing Detector (ft)		0		0	0					0	0	0
Detector 1 Position(ft)		0		0	0					0	0	0
Detector 1 Size(ft)		6		20	6					20	6	20
Detector 1 Type		Cl+Ex		Cl+Ex	Cl+Ex					Cl+Ex	Cl+Ex	Cl+Ex
Detector 1 Channel												
Detector 1 Extend (s)		0.0		0.0	0.0					0.0	0.0	0.0
Detector 1 Queue (s)		0.0		0.0	0.0					0.0	0.0	0.0
Detector 1 Delay (s)		0.0		0.0	0.0					0.0	0.0	0.0
Detector 2 Position(ft)		94			94							94
Detector 2 Size(ft)		6			6							6
Detector 2 Type		Cl+Ex			Cl+Ex							Cl+Ex
Detector 2 Channel												
Detector 2 Extend (s)		0.0			0.0							0.0
Turn Type		NA		Prot	NA					Perm	NA	Perm
Protected Phases		6		5	2							8

Lanes, Volumes, Timings

6: I-82 SB Entrance Ramp/I-82 SB Exit Ramp & 6th

11/08/2022

Lane Group	Ø1	Ø4
Lane Configurations		
Traffic Volume (vph)		
Future Volume (vph)		
Ideal Flow (vphpl)		
Storage Length (ft)		
Storage Lanes		
Taper Length (ft)		
Lane Util. Factor		
Frt		
Flt Protected		
Satd. Flow (prot)		
Flt Permitted		
Satd. Flow (perm)		
Right Turn on Red		
Satd. Flow (RTOR)		
Link Speed (mph)		
Link Distance (ft)		
Travel Time (s)		
Peak Hour Factor		
Heavy Vehicles (%)		
Adj. Flow (vph)		
Shared Lane Traffic (%)		
Lane Group Flow (vph)		
Enter Blocked Intersection		
Lane Alignment		
Median Width(ft)		
Link Offset(ft)		
Crosswalk Width(ft)		
Two way Left Turn Lane		
Headway Factor		
Turning Speed (mph)		
Number of Detectors		
Detector Template		
Leading Detector (ft)		
Trailing Detector (ft)		
Detector 1 Position(ft)		
Detector 1 Size(ft)		
Detector 1 Type		
Detector 1 Channel		
Detector 1 Extend (s)		
Detector 1 Queue (s)		
Detector 1 Delay (s)		
Detector 2 Position(ft)		
Detector 2 Size(ft)		
Detector 2 Type		
Detector 2 Channel		
Detector 2 Extend (s)		
Turn Type		
Protected Phases	1	4

Lanes, Volumes, Timings
 6: I-82 SB Entrance Ramp/I-82 SB Exit Ramp & 6th

11/08/2022



Lane Group	EBL	EBT	EBR	WBL	WBT	WBR	NBL	NBT	NBR	SBL	SBT	SBR
Permitted Phases										8		8
Detector Phase		6		5	2					8	8	8
Switch Phase												
Minimum Initial (s)		10.0		7.0	10.0					7.0	7.0	7.0
Minimum Split (s)		40.5		13.0	36.5					37.0	37.0	37.0
Total Split (s)		43.0		15.0	45.0					37.0	37.0	37.0
Total Split (%)		45.3%		15.8%	47.4%					38.9%	38.9%	38.9%
Maximum Green (s)		38.5		10.5	40.5					32.5	32.5	32.5
Yellow Time (s)		4.0		4.0	4.0					4.0	4.0	4.0
All-Red Time (s)		0.5		0.5	0.5					0.5	0.5	0.5
Lost Time Adjust (s)		0.0		0.0	0.0						0.0	0.0
Total Lost Time (s)		4.5		4.5	4.5						4.5	4.5
Lead/Lag		Lag		Lead	Lag							
Lead-Lag Optimize?		Yes		Yes	Yes							
Vehicle Extension (s)		5.6		3.5	4.6					5.0	5.0	5.0
Minimum Gap (s)		3.6		2.0	2.6					5.0	5.0	5.0
Time Before Reduce (s)		10.0		10.0	10.0					5.0	5.0	5.0
Time To Reduce (s)		10.0		10.0	10.0					5.0	5.0	5.0
Recall Mode		Min		None	Min					None	None	None
Walk Time (s)		7.0			7.0					7.0	7.0	7.0
Flash Dont Walk (s)		29.0			22.0					25.0	25.0	25.0
Pedestrian Calls (#/hr)		0			0					0	0	0
Act Effct Green (s)		38.9		9.6	42.8						31.2	31.2
Actuated g/C Ratio		0.43		0.11	0.47						0.34	0.34
v/c Ratio		0.93		0.56	0.42						0.87	0.74
Control Delay		23.6		52.6	18.0						47.0	17.5
Queue Delay		0.0		0.0	0.1						0.0	0.7
Total Delay		23.7		52.6	18.1						47.0	18.2
LOS		C		D	B						D	B
Approach Delay		23.7			22.6						32.0	
Approach LOS		C			C						C	
Queue Length 50th (ft)		87		57	147						258	97
Queue Length 95th (ft)		#458		110	197						#439	231
Internal Link Dist (ft)		156			401			109			416	
Turn Bay Length (ft)				125								
Base Capacity (vph)		1324		197	1614						562	698
Starvation Cap Reductn		1		0	0						0	0
Spillback Cap Reductn		0		0	210						0	43
Storage Cap Reductn		0		0	0						0	0
Reduced v/c Ratio		0.93		0.50	0.48						0.82	0.76

Intersection Summary

Area Type:	Other
Cycle Length:	95
Actuated Cycle Length:	90.5
Natural Cycle:	95
Control Type:	Actuated-Uncoordinated
Maximum v/c Ratio:	0.93
Intersection Signal Delay:	26.1
Intersection LOS:	C

Lanes, Volumes, Timings

6: I-82 SB Entrance Ramp/I-82 SB Exit Ramp & 6th

11/08/2022

Lane Group	Ø1	Ø4
Permitted Phases		
Detector Phase		
Switch Phase		
Minimum Initial (s)	7.0	7.0
Minimum Split (s)	13.0	36.5
Total Split (s)	13.0	37.0
Total Split (%)	14%	39%
Maximum Green (s)	8.5	32.5
Yellow Time (s)	4.0	4.0
All-Red Time (s)	0.5	0.5
Lost Time Adjust (s)		
Total Lost Time (s)		
Lead/Lag	Lead	
Lead-Lag Optimize?	Yes	
Vehicle Extension (s)	3.5	3.5
Minimum Gap (s)	2.0	2.0
Time Before Reduce (s)	10.0	15.0
Time To Reduce (s)	10.0	15.0
Recall Mode	None	None
Walk Time (s)		7.0
Flash Dont Walk (s)		23.0
Pedestrian Calls (#/hr)		0
Act Effct Green (s)		
Actuated g/C Ratio		
v/c Ratio		
Control Delay		
Queue Delay		
Total Delay		
LOS		
Approach Delay		
Approach LOS		
Queue Length 50th (ft)		
Queue Length 95th (ft)		
Internal Link Dist (ft)		
Turn Bay Length (ft)		
Base Capacity (vph)		
Starvation Cap Reductn		
Spillback Cap Reductn		
Storage Cap Reductn		
Reduced v/c Ratio		
Intersection Summary		

Lanes, Volumes, Timings

6: I-82 SB Entrance Ramp/I-82 SB Exit Ramp & 6th

11/08/2022

Intersection Capacity Utilization 70.6% ICU Level of Service C

Analysis Period (min) 15

95th percentile volume exceeds capacity, queue may be longer.

Queue shown is maximum after two cycles.



















Splits and Phases: 6: I-82 SB Entrance Ramp/I-82 SB Exit Ramp & 6th



Lanes, Volumes, Timings

7: I-82 NB Exit Ramp/I-82 NB Entrance Ramp & 6th

11/08/2022

												
Lane Group	EBL	EBT	EBR	WBL	WBT	WBR	NBL	NBT	NBR	SBL	SBT	SBR
Lane Configurations												
Traffic Volume (vph)	415	910	0	0	660	645	40	5	170	0	0	0
Future Volume (vph)	415	910	0	0	660	645	40	5	170	0	0	0
Ideal Flow (vphpl)	1900	1900	1900	1900	1900	1900	1900	1900	1900	1900	1900	1900
Storage Length (ft)	250		0	0		0	0		215	0		0
Storage Lanes	1		0	0		0	0		1	0		0
Taper Length (ft)	45			25			25			25		
Lane Util. Factor	0.97	1.00	1.00	1.00	0.95	0.95	1.00	1.00	1.00	1.00	1.00	1.00
Frt					0.926				0.850			
Flt Protected	0.950							0.957				
Satd. Flow (prot)	3335	1810	0	0	3184	0	0	1478	1313	0	0	0
Flt Permitted	0.950							0.957				
Satd. Flow (perm)	3335	1810	0	0	3184	0	0	1478	1313	0	0	0
Right Turn on Red			Yes			Yes			Yes			Yes
Satd. Flow (RTOR)					349				136			
Link Speed (mph)		35			45			45			45	
Link Distance (ft)		481			3338			681			572	
Travel Time (s)		9.4			50.6			10.3			8.7	
Peak Hour Factor	0.80	0.80	0.80	0.85	0.85	0.85	0.82	0.82	0.82	0.92	0.92	0.92
Heavy Vehicles (%)	5%	5%	5%	5%	5%	5%	23%	23%	23%	2%	2%	2%
Adj. Flow (vph)	519	1138	0	0	776	759	49	6	207	0	0	0
Shared Lane Traffic (%)												
Lane Group Flow (vph)	519	1138	0	0	1535	0	0	55	207	0	0	0
Enter Blocked Intersection	No	No	No	No	No	No	No	No	No	No	No	No
Lane Alignment	Left	Left	Right	Left	Left	Right	Left	Left	Right	Left	Left	Right
Median Width(ft)		24			24			0			0	
Link Offset(ft)		0			0			0			0	
Crosswalk Width(ft)		16			16			16			16	
Two way Left Turn Lane												
Headway Factor	1.00	1.00	1.00	1.00	1.00	1.00	1.00	1.00	1.00	1.00	1.00	1.00
Turning Speed (mph)	15		9	15		9	15		9	15		9
Number of Detectors	1	2			2		1	2	1			
Detector Template	Left	Thru			Thru		Left	Thru	Right			
Leading Detector (ft)	20	100			100		20	100	20			
Trailing Detector (ft)	0	0			0		0	0	0			
Detector 1 Position(ft)	0	0			0		0	0	0			
Detector 1 Size(ft)	20	6			6		20	6	20			
Detector 1 Type	Cl+Ex	Cl+Ex			Cl+Ex		Cl+Ex	Cl+Ex	Cl+Ex			
Detector 1 Channel												
Detector 1 Extend (s)	0.0	0.0			0.0		0.0	0.0	0.0			
Detector 1 Queue (s)	0.0	0.0			0.0		0.0	0.0	0.0			
Detector 1 Delay (s)	0.0	0.0			0.0		0.0	0.0	0.0			
Detector 2 Position(ft)		94			94			94				
Detector 2 Size(ft)		6			6			6				
Detector 2 Type		Cl+Ex			Cl+Ex			Cl+Ex				
Detector 2 Channel												
Detector 2 Extend (s)		0.0			0.0			0.0				
Turn Type	Prot	NA			NA		Perm	NA	Perm			
Protected Phases	7	4			8			2				

Lanes, Volumes, Timings

7: I-82 NB Exit Ramp/I-82 NB Entrance Ramp & 6th

11/08/2022

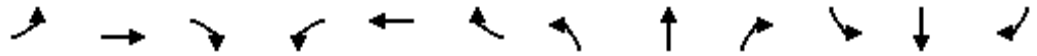

Lane Group	EBL	EBT	EBR	WBL	WBT	WBR	NBL	NBT	NBR	SBL	SBT	SBR
Permitted Phases							2		2			
Detector Phase	7	4			8		2	2	2			
Switch Phase												
Minimum Initial (s)	5.0	5.0			5.0		5.0	5.0	5.0			
Minimum Split (s)	9.5	22.5			22.5		22.5	22.5	22.5			
Total Split (s)	24.0	73.0			49.0		22.0	22.0	22.0			
Total Split (%)	25.3%	76.8%			51.6%		23.2%	23.2%	23.2%			
Maximum Green (s)	19.5	68.5			44.5		17.5	17.5	17.5			
Yellow Time (s)	3.5	3.5			3.5		3.5	3.5	3.5			
All-Red Time (s)	1.0	1.0			1.0		1.0	1.0	1.0			
Lost Time Adjust (s)	0.0	0.0			0.0			0.0	0.0			
Total Lost Time (s)	4.5	4.5			4.5			4.5	4.5			
Lead/Lag	Lead				Lag							
Lead-Lag Optimize?	Yes				Yes							
Vehicle Extension (s)	3.0	3.0			3.0		3.0	3.0	3.0			
Recall Mode	None	None			None		C-Max	C-Max	C-Max			
Walk Time (s)		7.0			7.0		7.0	7.0	7.0			
Flash Dont Walk (s)		11.0			11.0		11.0	11.0	11.0			
Pedestrian Calls (#/hr)		0			0		0	0	0			
Act Effct Green (s)	18.3	66.7			43.9			19.3	19.3			
Actuated g/C Ratio	0.19	0.70			0.46			0.20	0.20			
v/c Ratio	0.81	0.90			0.93			0.18	0.55			
Control Delay	47.4	22.3			29.3			34.8	19.5			
Queue Delay	0.0	29.0			0.0			0.0	0.0			
Total Delay	47.4	51.2			29.3			34.8	19.5			
LOS	D	D			C			C	B			
Approach Delay		50.0			29.3			22.7				
Approach LOS		D			C			C				
Queue Length 50th (ft)	153	437			358			28	37			
Queue Length 95th (ft)	181	488			418			57	90			
Internal Link Dist (ft)		401			3258			601			492	
Turn Bay Length (ft)	250								215			
Base Capacity (vph)	684	1305			1683			301	375			
Starvation Cap Reductn	0	225			0			0	0			
Spillback Cap Reductn	0	0			0			0	0			
Storage Cap Reductn	0	0			0			0	0			
Reduced v/c Ratio	0.76	1.05			0.91			0.18	0.55			

Intersection Summary

Area Type: Other
 Cycle Length: 95
 Actuated Cycle Length: 95
 Offset: 0 (0%), Referenced to phase 2:NBTL and 6:, Start of Green
 Natural Cycle: 90
 Control Type: Actuated-Coordinated
 Maximum v/c Ratio: 0.93
 Intersection Signal Delay: 38.8
 Intersection Capacity Utilization 108.7%
 Analysis Period (min) 15
 Intersection LOS: D
 ICU Level of Service G

Lanes, Volumes, Timings

7: I-82 NB Exit Ramp/I-82 NB Entrance Ramp & 6th

11/08/2022

Splits and Phases: 7: I-82 NB Exit Ramp/I-82 NB Entrance Ramp & 6th

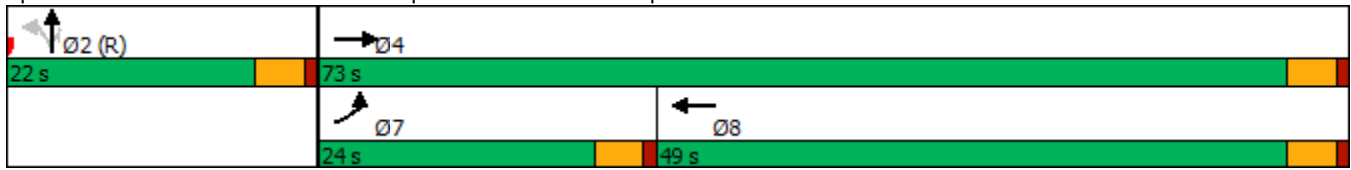

Lanes, Volumes, Timings
8: Devore & 6th

11/08/2022

Lane Group	EBL	EBT	EBR	WBL	WBT	WBR	NBL	NBT	NBR	SBL	SBT	SBR
Lane Configurations												
Traffic Volume (vph)	10	380	0	420	690	10	625	15	335	10	20	55
Future Volume (vph)	10	380	0	420	690	10	625	15	335	10	20	55
Ideal Flow (vphpl)	1900	1900	1900	1900	1900	1900	1900	1900	1900	1900	1900	1900
Storage Length (ft)	125		0	145		0	0		0	0		0
Storage Lanes	1		0	2		0	2		0	0		0
Taper Length (ft)	60			88			25			25		
Lane Util. Factor	1.00	0.95	1.00	0.97	0.95	0.95	0.97	1.00	1.00	1.00	1.00	1.00
Frt					0.998			0.857				0.913
Flt Protected	0.950			0.950			0.950					0.994
Satd. Flow (prot)	1770	3539	0	3433	3532	0	3433	1596	0	0	1690	0
Flt Permitted	0.950			0.950			0.950					0.910
Satd. Flow (perm)	1770	3539	0	3433	3532	0	3433	1596	0	0	1548	0
Right Turn on Red			Yes			Yes			Yes			Yes
Satd. Flow (RTOR)					1			372				67
Link Speed (mph)		45			45			45				45
Link Distance (ft)		343			889			455				382
Travel Time (s)		5.2			13.5			6.9				5.8
Peak Hour Factor	0.82	0.82	0.82	0.72	0.72	0.72	0.90	0.90	0.90	0.42	0.42	0.42
Adj. Flow (vph)	12	463	0	583	958	14	694	17	372	24	48	131
Shared Lane Traffic (%)												
Lane Group Flow (vph)	12	463	0	583	972	0	694	389	0	0	203	0
Enter Blocked Intersection	No	No	No	No	No	No	No	No	No	No	No	No
Lane Alignment	Left	Left	Right	Left	Left	Right	Left	Left	Right	Left	Left	Right
Median Width(ft)		24			24			24				24
Link Offset(ft)		0			0			0				0
Crosswalk Width(ft)		16			16			16				16
Two way Left Turn Lane												
Headway Factor	1.00	1.00	1.00	1.00	1.00	1.00	1.00	1.00	1.00	1.00	1.00	1.00
Turning Speed (mph)	15		9	15		9	15		9	15		9
Number of Detectors	1	2		1	2		1	2		1	2	
Detector Template	Left	Thru		Left	Thru		Left	Thru		Left	Thru	
Leading Detector (ft)	20	100		20	100		20	100		20	100	
Trailing Detector (ft)	0	0		0	0		0	0		0	0	
Detector 1 Position(ft)	0	0		0	0		0	0		0	0	
Detector 1 Size(ft)	20	6		20	6		20	6		20	6	
Detector 1 Type	Cl+Ex	Cl+Ex		Cl+Ex	Cl+Ex		Cl+Ex	Cl+Ex		Cl+Ex	Cl+Ex	
Detector 1 Channel												
Detector 1 Extend (s)	0.0	0.0		0.0	0.0		0.0	0.0		0.0	0.0	
Detector 1 Queue (s)	0.0	0.0		0.0	0.0		0.0	0.0		0.0	0.0	
Detector 1 Delay (s)	0.0	0.0		0.0	0.0		0.0	0.0		0.0	0.0	
Detector 2 Position(ft)		94			94			94				94
Detector 2 Size(ft)		6			6			6				6
Detector 2 Type		Cl+Ex			Cl+Ex			Cl+Ex				Cl+Ex
Detector 2 Channel												
Detector 2 Extend (s)		0.0			0.0			0.0				0.0
Turn Type	Prot	NA		Prot	NA		Prot	NA		Perm	NA	
Protected Phases	5	2		1	6		3	8				4
Permitted Phases										4		

Lanes, Volumes, Timings
8: Devore & 6th

11/08/2022



Lane Group	EBL	EBT	EBR	WBL	WBT	WBR	NBL	NBT	NBR	SBL	SBT	SBR
Detector Phase	5	2		1	6		3	8		4	4	
Switch Phase												
Minimum Initial (s)	8.0	10.0		8.0	10.0		5.0	8.0		7.0	7.0	
Minimum Split (s)	13.0	36.5		13.0	31.5		9.5	46.5		36.5	36.5	
Total Split (s)	13.0	37.0		26.0	50.0		30.5	67.0		36.5	36.5	
Total Split (%)	10.0%	28.5%		20.0%	38.5%		23.5%	51.5%		28.1%	28.1%	
Maximum Green (s)	8.5	31.5		21.5	44.5		26.0	61.5		32.0	32.0	
Yellow Time (s)	4.0	5.0		4.0	5.0		3.5	5.0		4.0	4.0	
All-Red Time (s)	0.5	0.5		0.5	0.5		1.0	0.5		0.5	0.5	
Lost Time Adjust (s)	0.0	0.0		0.0	0.0		0.0	0.0			0.0	
Total Lost Time (s)	4.5	5.5		4.5	5.5		4.5	5.5			4.5	
Lead/Lag	Lead	Lag		Lead	Lag		Lead			Lag	Lag	
Lead-Lag Optimize?	Yes	Yes		Yes	Yes		Yes			Yes	Yes	
Vehicle Extension (s)	2.5	7.0		3.5	5.4		3.0	3.5		2.5	2.5	
Minimum Gap (s)	1.0	3.4		2.5	3.4		3.0	1.5		1.0	1.0	
Time Before Reduce (s)	5.0	15.0		5.0	15.0		0.0	10.0		5.0	5.0	
Time To Reduce (s)	5.0	15.0		5.0	15.0		0.0	10.0		5.0	5.0	
Recall Mode	None	Min		None	Min		None	None		None	None	
Walk Time (s)		7.0			7.0			7.0		7.0	7.0	
Flash Dont Walk (s)		24.0			19.0			34.0		25.0	25.0	
Pedestrian Calls (#/hr)		0			0			0		0	0	
Act Effct Green (s)	8.1	23.5		21.7	47.6		26.2	44.3			14.5	
Actuated g/C Ratio	0.08	0.22		0.21	0.45		0.25	0.42			0.14	
v/c Ratio	0.09	0.59		0.82	0.61		0.81	0.44			0.75	
Control Delay	51.4	40.1		52.1	25.2		47.1	4.2			46.5	
Queue Delay	0.0	0.0		0.0	0.0		0.0	0.0			0.0	
Total Delay	51.4	40.1		52.1	25.2		47.1	4.2			46.5	
LOS	D	D		D	C		D	A			D	
Approach Delay		40.4			35.3			31.7			46.5	
Approach LOS		D			D			C			D	
Queue Length 50th (ft)	7	145		189	238		220	6			87	
Queue Length 95th (ft)	26	194		231	310		#391	65			48	
Internal Link Dist (ft)		263			809			375			302	
Turn Bay Length (ft)	125			145								
Base Capacity (vph)	144	1070		708	1602		856	1094			521	
Starvation Cap Reductn	0	0		0	0		0	0			0	
Spillback Cap Reductn	0	0		0	0		0	0			0	
Storage Cap Reductn	0	0		0	0		0	0			0	
Reduced v/c Ratio	0.08	0.43		0.82	0.61		0.81	0.36			0.39	

Intersection Summary

Area Type:	Other
Cycle Length:	130
Actuated Cycle Length:	105.1
Natural Cycle:	130
Control Type:	Actuated-Uncoordinated
Maximum v/c Ratio:	0.82
Intersection Signal Delay:	35.6
Intersection LOS:	D
Intersection Capacity Utilization:	63.5%
ICU Level of Service:	B

Lanes, Volumes, Timings

8: Devore & 6th

11/08/2022

Analysis Period (min) 15

95th percentile volume exceeds capacity, queue may be longer.

Queue shown is maximum after two cycles.

Splits and Phases: 8: Devore & 6th

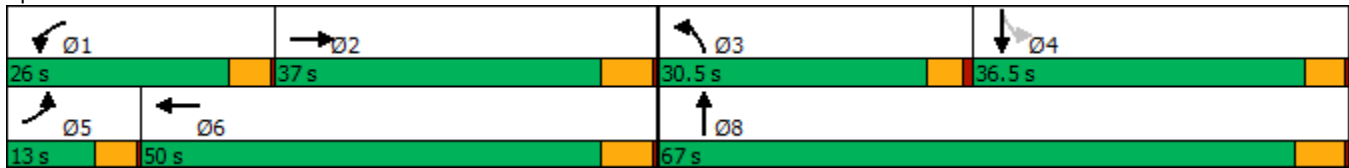

Lanes, Volumes, Timings

12: 6th

11/08/2022

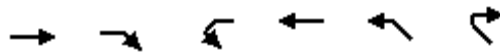

Lane Group	EBT	EBR	WBL	WBT	NWL	NWR
Lane Configurations	↑↑			↑↑		
Traffic Volume (vph)	390	610	0	1370	0	0
Future Volume (vph)	390	610	0	1370	0	0
Ideal Flow (vphpl)	1900	1900	1900	1900	1900	1900
Lane Util. Factor	0.95	0.95	1.00	0.95	1.00	1.00
Frt	0.909					
Flt Protected						
Satd. Flow (prot)	3011	0	0	3438	0	0
Flt Permitted						
Satd. Flow (perm)	3011	0	0	3438	0	0
Link Speed (mph)	45		45		45	
Link Distance (ft)	3338		343		639	
Travel Time (s)	50.6		5.2		9.7	
Peak Hour Factor	0.82	0.82	0.72	0.72	0.92	0.92
Heavy Vehicles (%)	9%	9%	5%	5%	2%	2%
Adj. Flow (vph)	476	744	0	1903	0	0
Shared Lane Traffic (%)						
Lane Group Flow (vph)	1220	0	0	1903	0	0
Enter Blocked Intersection	No	No	No	No	No	No
Lane Alignment	Left	Right	Left	Left	Left	Right
Median Width(ft)	12		12		0	
Link Offset(ft)	0		0		0	
Crosswalk Width(ft)	16		16		16	
Two way Left Turn Lane						
Headway Factor	1.00	1.00	1.00	1.00	1.00	1.00
Turning Speed (mph)	9		15		15	
Sign Control	Free		Free		Free	







Intersection Summary

Area Type:	Other
Control Type:	Unsignalized
Intersection Capacity Utilization	41.2% ICU Level of Service A
Analysis Period (min)	15

Lanes, Volumes, Timings

13: Devore

11/08/2022

						
Lane Group	NBL	NBT	SBT	SBR	SEL	SER
Lane Configurations		↑↑	↑↑			↗
Traffic Volume (vph)	0	649	232	0	0	397
Future Volume (vph)	0	649	232	0	0	397
Ideal Flow (vphpl)	1900	1900	1900	1900	1900	1900
Lane Util. Factor	1.00	0.95	0.95	1.00	1.00	1.00
Fr _t						0.865
Fl _t Protected						
Satd. Flow (prot)	0	3471	3471	0	0	1508
Fl _t Permitted						
Satd. Flow (perm)	0	3471	3471	0	0	1508
Link Speed (mph)		45	45		45	
Link Distance (ft)		235	455		639	
Travel Time (s)		3.6	6.9		9.7	
Peak Hour Factor	0.90	0.90	0.92	0.92	0.82	0.82
Heavy Vehicles (%)	4%	4%	4%	4%	9%	9%
Adj. Flow (vph)	0	721	252	0	0	484
Shared Lane Traffic (%)						
Lane Group Flow (vph)	0	721	252	0	0	484
Enter Blocked Intersection	No	No	No	No	No	No
Lane Alignment	Left	Left	L NA	Right	Left	R NA
Median Width(ft)		0	0		0	
Link Offset(ft)		0	0		0	
Crosswalk Width(ft)		16	16		16	
Two way Left Turn Lane						
Headway Factor	1.00	1.00	1.00	1.00	1.00	1.00
Turning Speed (mph)	15			9	15	9
Sign Control		Free	Free		Free	
Intersection Summary						
Area Type:	Other					
Control Type:	Unsignalized					
Intersection Capacity Utilization	37.7%			ICU Level of Service A		
Analysis Period (min)	15					

Lanes, Volumes, Timings
2: Powerline & Hwy 730

11/22/2022

	→	↘	↙	←	↖	↗
Lane Group	EBT	EBR	WBL	WBT	NBL	NBR
Lane Configurations	↑	↗	↙	↑	↖	↗
Traffic Volume (vph)	455	230	475	390	240	345
Future Volume (vph)	455	230	475	390	240	345
Ideal Flow (vphpl)	1900	1900	1900	1900	1900	1900
Lane Width (ft)	12	12	12	12	12	12
Grade (%)	0%			0%	0%	
Storage Length (ft)		100	180		0	150
Storage Lanes		1	1		1	1
Taper Length (ft)			100		25	
Lane Util. Factor	1.00	1.00	1.00	1.00	1.00	1.00
Ped Bike Factor						
Frt		0.850				0.850
Flt Protected			0.950		0.950	
Satd. Flow (prot)	1863	1583	1770	1863	1770	1583
Flt Permitted			0.142		0.950	
Satd. Flow (perm)	1863	1583	265	1863	1770	1583
Right Turn on Red		Yes				Yes
Satd. Flow (RTOR)		164				375
Link Speed (mph)	40			40	35	
Link Distance (ft)	728			823	449	
Travel Time (s)	12.4			14.0	8.7	
Confl. Peds. (#/hr)						
Confl. Bikes (#/hr)						
Peak Hour Factor	0.92	0.92	0.92	0.92	0.92	0.92
Growth Factor	100%	100%	100%	100%	100%	100%
Heavy Vehicles (%)	2%	2%	2%	2%	2%	2%
Bus Blockages (#/hr)	0	0	0	0	0	0
Parking (#/hr)						
Mid-Block Traffic (%)	0%			0%	0%	
Adj. Flow (vph)	495	250	516	424	261	375
Shared Lane Traffic (%)						
Lane Group Flow (vph)	495	250	516	424	261	375
Enter Blocked Intersection	No	No	No	No	No	No
Lane Alignment	Left	Right	Left	Left	Left	Right
Median Width(ft)	12			12	12	
Link Offset(ft)	0			0	0	
Crosswalk Width(ft)	16			16	16	
Two way Left Turn Lane						
Headway Factor	1.00	1.00	1.00	1.00	1.00	1.00
Turning Speed (mph)		9	15		15	9
Number of Detectors	2	1	1	2	1	1
Detector Template	Thru	Right	Left	Thru	Left	Right
Leading Detector (ft)	100	20	20	100	20	20
Trailing Detector (ft)	0	0	0	0	0	0
Turn Type	NA	Perm	pm+pt	NA	Prot	Perm
Protected Phases	4		3	8	2	
Permitted Phases		4	8			2
Detector Phase	4	4	3	8	2	2
Switch Phase						

Lanes, Volumes, Timings
2: Powerline & Hwy 730

11/22/2022



Lane Group	EBT	EBR	WBL	WBT	NBL	NBR
Minimum Initial (s)	5.0	5.0	5.0	5.0	5.0	5.0
Minimum Split (s)	22.5	22.5	9.5	22.5	22.5	22.5
Total Split (s)	29.0	29.0	26.0	55.0	25.0	25.0
Total Split (%)	36.3%	36.3%	32.5%	68.8%	31.3%	31.3%
Maximum Green (s)	24.5	24.5	21.5	50.5	20.5	20.5
Yellow Time (s)	3.5	3.5	3.5	3.5	3.5	3.5
All-Red Time (s)	1.0	1.0	1.0	1.0	1.0	1.0
Lost Time Adjust (s)	0.0	0.0	0.0	0.0	0.0	0.0
Total Lost Time (s)	4.5	4.5	4.5	4.5	4.5	4.5
Lead/Lag	Lag	Lag	Lead			
Lead-Lag Optimize?	Yes	Yes	Yes			
Vehicle Extension (s)	3.0	3.0	3.0	3.0	3.0	3.0
Minimum Gap (s)	3.0	3.0	3.0	3.0	3.0	3.0
Time Before Reduce (s)	0.0	0.0	0.0	0.0	0.0	0.0
Time To Reduce (s)	0.0	0.0	0.0	0.0	0.0	0.0
Recall Mode	None	None	None	None	C-Max	C-Max
Walk Time (s)	7.0	7.0		7.0	7.0	7.0
Flash Dont Walk (s)	11.0	11.0		11.0	11.0	11.0
Pedestrian Calls (#/hr)	0	0		0	0	0
Act Effct Green (s)	23.6	23.6	49.0	49.0	22.0	22.0
Actuated g/C Ratio	0.30	0.30	0.61	0.61	0.28	0.28
v/c Ratio	0.90	0.43	0.93	0.37	0.54	0.53
Control Delay	49.0	10.7	44.6	8.6	30.3	6.0
Queue Delay	0.0	0.0	0.0	0.0	0.0	0.0
Total Delay	49.0	10.7	44.6	8.6	30.3	6.0
LOS	D	B	D	A	C	A
Approach Delay	36.1			28.4	16.0	
Approach LOS	D			C	B	
Queue Length 50th (ft)	232	31	190	90	114	0
Queue Length 95th (ft)	#403	90	#377	140	189	64
Internal Link Dist (ft)	648			743	369	
Turn Bay Length (ft)		100	180			150
Base Capacity (vph)	570	598	566	1176	486	706
Starvation Cap Reductn	0	0	0	0	0	0
Spillback Cap Reductn	0	0	0	0	0	0
Storage Cap Reductn	0	0	0	0	0	0
Reduced v/c Ratio	0.87	0.42	0.91	0.36	0.54	0.53

Intersection Summary

Area Type:	Other
Cycle Length:	80
Actuated Cycle Length:	80
Offset:	0 (0%), Referenced to phase 2:NBL and 6:, Start of Green
Natural Cycle:	80
Control Type:	Actuated-Coordinated
Maximum v/c Ratio:	0.93
Intersection Signal Delay:	27.5
Intersection LOS:	C
Intersection Capacity Utilization:	74.8%
ICU Level of Service:	D
Analysis Period (min):	15

Lanes, Volumes, Timings

2: Powerline & Hwy 730

11/22/2022

95th percentile volume exceeds capacity, queue may be longer.
 Queue shown is maximum after two cycles.

Splits and Phases: 2: Powerline & Hwy 730

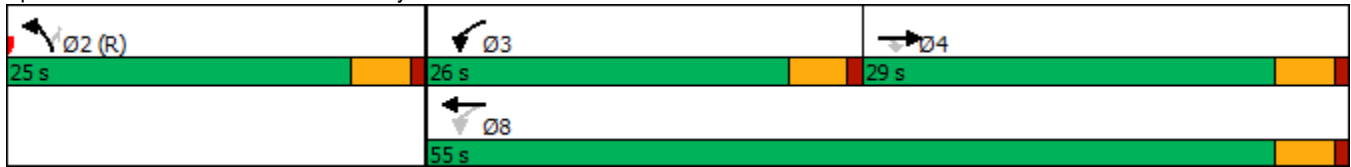

Lanes, Volumes, Timings

4:

11/22/2022

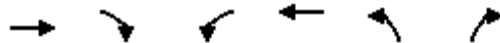

Lane Group	EBT	EBR	WBL	WBT	NBL	NBR
Lane Configurations	↑	↗	↘	↑	↘	↗
Traffic Volume (vph)	665	210	145	750	185	125
Future Volume (vph)	665	210	145	750	185	125
Ideal Flow (vphpl)	1900	1900	1900	1900	1900	1900
Lane Width (ft)	12	12	12	12	12	12
Grade (%)	0%			0%	0%	
Storage Length (ft)		127	150		0	30
Storage Lanes		1	1		1	1
Taper Length (ft)			75		25	
Lane Util. Factor	1.00	1.00	1.00	1.00	1.00	1.00
Ped Bike Factor						
Frt		0.850				0.850
Flt Protected			0.950		0.950	
Satd. Flow (prot)	1863	1583	1770	1863	1770	1583
Flt Permitted			0.127		0.950	
Satd. Flow (perm)	1863	1583	237	1863	1770	1583
Right Turn on Red		Yes				Yes
Satd. Flow (RTOR)		184				116
Link Speed (mph)	45			45	45	
Link Distance (ft)	1042			902	649	
Travel Time (s)	15.8			13.7	9.8	
Confl. Peds. (#/hr)						
Confl. Bikes (#/hr)						
Peak Hour Factor	0.92	0.92	0.92	0.92	0.92	0.92
Growth Factor	100%	100%	100%	100%	100%	100%
Heavy Vehicles (%)	2%	2%	2%	2%	2%	2%
Bus Blockages (#/hr)	0	0	0	0	0	0
Parking (#/hr)						
Mid-Block Traffic (%)	0%			0%	0%	
Adj. Flow (vph)	723	228	158	815	201	136
Shared Lane Traffic (%)						
Lane Group Flow (vph)	723	228	158	815	201	136
Enter Blocked Intersection	No	No	No	No	No	No
Lane Alignment	Left	Right	Left	Left	Left	Right
Median Width(ft)	12			12	12	
Link Offset(ft)	0			0	0	
Crosswalk Width(ft)	16			16	16	
Two way Left Turn Lane	Yes					
Headway Factor	1.00	1.00	1.00	1.00	1.00	1.00
Turning Speed (mph)		9	15		15	9
Number of Detectors	2	1	1	2	1	1
Detector Template	Thru	Right	Left	Thru	Left	Right
Leading Detector (ft)	100	20	20	100	20	20
Trailing Detector (ft)	0	0	0	0	0	0
Turn Type	NA	Perm	pm+pt	NA	Prot	Perm
Protected Phases	4		3	8	2	
Permitted Phases		4	8			2
Detector Phase	4	4	3	8	2	2
Switch Phase						

Lanes, Volumes, Timings

4:

11/22/2022

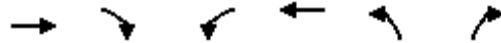

Lane Group	EBT	EBR	WBL	WBT	NBL	NBR
Minimum Initial (s)	5.0	5.0	5.0	5.0	5.0	5.0
Minimum Split (s)	22.5	22.5	9.5	22.5	22.5	22.5
Total Split (s)	32.0	32.0	9.5	41.5	23.5	23.5
Total Split (%)	49.2%	49.2%	14.6%	63.8%	36.2%	36.2%
Maximum Green (s)	27.5	27.5	5.0	37.0	19.0	19.0
Yellow Time (s)	3.5	3.5	3.5	3.5	3.5	3.5
All-Red Time (s)	1.0	1.0	1.0	1.0	1.0	1.0
Lost Time Adjust (s)	0.0	0.0	0.0	0.0	0.0	0.0
Total Lost Time (s)	4.5	4.5	4.5	4.5	4.5	4.5
Lead/Lag	Lag	Lag	Lead			
Lead-Lag Optimize?	Yes	Yes	Yes			
Vehicle Extension (s)	3.0	3.0	3.0	3.0	3.0	3.0
Minimum Gap (s)	3.0	3.0	3.0	3.0	3.0	3.0
Time Before Reduce (s)	0.0	0.0	0.0	0.0	0.0	0.0
Time To Reduce (s)	0.0	0.0	0.0	0.0	0.0	0.0
Recall Mode	None	None	None	None	C-Max	C-Max
Walk Time (s)	7.0	7.0		7.0	7.0	7.0
Flash Dont Walk (s)	11.0	11.0		11.0	11.0	11.0
Pedestrian Calls (#/hr)	0	0		0	0	0
Act Effct Green (s)	26.9	26.9	36.4	36.4	19.6	19.6
Actuated g/C Ratio	0.41	0.41	0.56	0.56	0.30	0.30
v/c Ratio	0.94	0.30	0.63	0.78	0.38	0.24
Control Delay	41.1	4.6	20.6	17.8	20.8	6.6
Queue Delay	0.0	0.0	0.0	0.0	0.0	0.0
Total Delay	41.1	4.6	20.6	17.8	20.8	6.6
LOS	D	A	C	B	C	A
Approach Delay	32.4			18.3	15.1	
Approach LOS	C			B	B	
Queue Length 50th (ft)	259	10	27	222	63	6
Queue Length 95th (ft)	#469	47	#79	367	116	41
Internal Link Dist (ft)	962			822	569	
Turn Bay Length (ft)		127	150			30
Base Capacity (vph)	788	775	250	1060	534	559
Starvation Cap Reductn	0	0	0	0	0	0
Spillback Cap Reductn	0	0	0	0	0	0
Storage Cap Reductn	0	0	0	0	0	0
Reduced v/c Ratio	0.92	0.29	0.63	0.77	0.38	0.24

Intersection Summary

Area Type:	Other
Cycle Length:	65
Actuated Cycle Length:	65
Offset:	0 (0%), Referenced to phase 2:NBL and 6:, Start of Green
Natural Cycle:	65
Control Type:	Actuated-Coordinated
Maximum v/c Ratio:	0.94
Intersection Signal Delay:	23.7
Intersection LOS:	C
Intersection Capacity Utilization:	64.5%
ICU Level of Service:	C
Analysis Period (min):	15

Lanes, Volumes, Timings

4:

11/22/2022

95th percentile volume exceeds capacity, queue may be longer.
 Queue shown is maximum after two cycles.

Splits and Phases: 4:

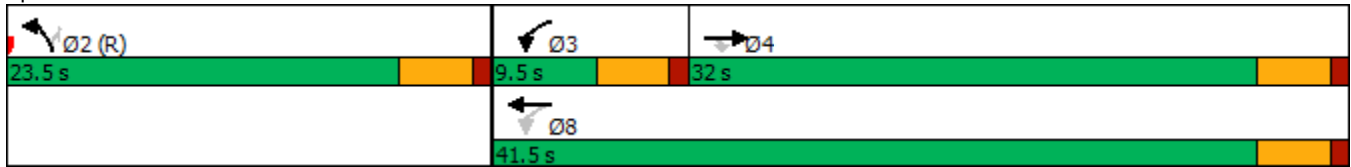

Lanes, Volumes, Timings
5: 6th & Brownell

11/22/2022

Lane Group	EBL	EBT	EBR	WBL	WBT	WBR	NBL	NBT	NBR	SBL	SBT	SBR
Lane Configurations												
Traffic Volume (vph)	35	830	5	15	990	70	15	5	55	165	5	25
Future Volume (vph)	35	830	5	15	990	70	15	5	55	165	5	25
Ideal Flow (vphpl)	1900	1900	1900	1900	1900	1900	1900	1900	1900	1900	1900	1900
Lane Width (ft)	12	12	12	12	12	12	12	12	12	12	12	12
Grade (%)		0%			0%			0%			0%	
Storage Length (ft)	165		0	0		0	0		0	0		0
Storage Lanes	1		0	1		0	0		0	0		1
Taper Length (ft)	135			25			25			25		
Lane Util. Factor	1.00	0.95	0.95	1.00	0.95	0.95	1.00	1.00	1.00	1.00	1.00	1.00
Ped Bike Factor												
Frt		0.999			0.990			0.901				0.850
Flt Protected	0.950			0.950				0.990			0.954	
Satd. Flow (prot)	1703	3402	0	1556	3081	0	0	1599	0	0	1119	997
Flt Permitted	0.950			0.950				0.934			0.698	
Satd. Flow (perm)	1703	3402	0	1556	3081	0	0	1508	0	0	819	997
Right Turn on Red			Yes			Yes			Yes			Yes
Satd. Flow (RTOR)		1			10			65				69
Link Speed (mph)		35			35			30				30
Link Distance (ft)		1078			236			248				460
Travel Time (s)		21.0			4.6			5.6				10.5
Confl. Peds. (#/hr)												
Confl. Bikes (#/hr)												
Peak Hour Factor	0.81	0.81	0.81	0.89	0.89	0.89	0.84	0.84	0.84	0.93	0.93	0.93
Growth Factor	100%	100%	100%	100%	100%	100%	100%	100%	100%	100%	100%	100%
Heavy Vehicles (%)	6%	6%	6%	16%	16%	16%	6%	6%	6%	62%	62%	62%
Bus Blockages (#/hr)	0	0	0	0	0	0	0	0	0	0	0	0
Parking (#/hr)												
Mid-Block Traffic (%)		0%			0%			0%			0%	
Adj. Flow (vph)	43	1025	6	17	1112	79	18	6	65	177	5	27
Shared Lane Traffic (%)												
Lane Group Flow (vph)	43	1031	0	17	1191	0	0	89	0	0	182	27
Enter Blocked Intersection	No	No	No	No	No	No	No	No	No	No	No	No
Lane Alignment	Left	Left	Right	Left	Left	Right	Left	Left	Right	Left	Left	Right
Median Width(ft)		12			12			0			0	
Link Offset(ft)		0			0			0			0	
Crosswalk Width(ft)		16			16			16			16	
Two way Left Turn Lane												
Headway Factor	1.00	1.00	1.00	1.00	1.00	1.00	1.00	1.00	1.00	1.00	1.00	1.00
Turning Speed (mph)	15		9	15		9	15		9	15		9
Number of Detectors	1	2		1	2		1	2		1	2	1
Detector Template	Left	Thru		Left	Thru		Left	Thru		Left	Thru	Right
Leading Detector (ft)	20	100		20	100		20	100		20	100	20
Trailing Detector (ft)	0	0		0	0		0	0		0	0	0
Turn Type	Prot	NA		Prot	NA		Perm	NA		Perm	NA	Perm
Protected Phases	1	6		5	2			4			8	
Permitted Phases							4			8		8
Detector Phase	1	6		5	2		4	4		8	8	8
Switch Phase												

Lanes, Volumes, Timings
5: 6th & Brownell

11/22/2022



Lane Group	EBL	EBT	EBR	WBL	WBT	WBR	NBL	NBT	NBR	SBL	SBT	SBR
Minimum Initial (s)	7.0	10.0		7.0	10.0		7.0	7.0		7.0	7.0	7.0
Minimum Split (s)	13.0	40.5		13.0	36.5		36.5	36.5		37.0	37.0	37.0
Total Split (s)	13.0	43.0		15.0	45.0		37.0	37.0		37.0	37.0	37.0
Total Split (%)	13.7%	45.3%		15.8%	47.4%		38.9%	38.9%		38.9%	38.9%	38.9%
Maximum Green (s)	8.5	38.5		10.5	40.5		32.5	32.5		32.5	32.5	32.5
Yellow Time (s)	4.0	4.0		4.0	4.0		4.0	4.0		4.0	4.0	4.0
All-Red Time (s)	0.5	0.5		0.5	0.5		0.5	0.5		0.5	0.5	0.5
Lost Time Adjust (s)	0.0	0.0		0.0	0.0			0.0			0.0	0.0
Total Lost Time (s)	4.5	4.5		4.5	4.5			4.5			4.5	4.5
Lead/Lag	Lead	Lag		Lead	Lag							
Lead-Lag Optimize?	Yes	Yes		Yes	Yes							
Vehicle Extension (s)	3.5	5.6		3.5	4.6		3.5	3.5		5.0	5.0	5.0
Minimum Gap (s)	2.0	3.6		2.0	2.6		2.0	2.0		5.0	5.0	5.0
Time Before Reduce (s)	10.0	10.0		10.0	10.0		15.0	15.0		5.0	5.0	5.0
Time To Reduce (s)	10.0	10.0		10.0	10.0		15.0	15.0		5.0	5.0	5.0
Recall Mode	None	Min		None	Min		None	None		None	None	None
Walk Time (s)		7.0			7.0		7.0	7.0		7.0	7.0	7.0
Flash Dont Walk (s)		29.0			22.0		23.0	23.0		25.0	25.0	25.0
Pedestrian Calls (#/hr)		0			0		0	0		0	0	0
Act Effct Green (s)	7.9	38.9		9.6	42.8			31.2			31.2	31.2
Actuated g/C Ratio	0.09	0.43		0.11	0.47			0.34			0.34	0.34
v/c Ratio	0.29	0.70		0.10	0.81			0.16			0.65	0.07
Control Delay	46.0	25.7		47.5	19.4			9.4			38.6	0.4
Queue Delay	0.0	0.7		0.0	12.6			0.0			0.0	0.0
Total Delay	46.0	26.3		47.5	32.0			9.4			38.6	0.4
LOS	D	C		D	C			A			D	A
Approach Delay		27.1			32.3			9.4			33.6	
Approach LOS		C			C			A			C	
Queue Length 50th (ft)	25	272		11	210			10			92	0
Queue Length 95th (ft)	52	299		m15	#461			38			#186	1
Internal Link Dist (ft)		998			156			168			380	
Turn Bay Length (ft)	165											
Base Capacity (vph)	161	1463		182	1479			588			297	405
Starvation Cap Reductn	0	0		0	287			0			0	0
Spillback Cap Reductn	0	164		0	0			2			0	0
Storage Cap Reductn	0	0		0	0			0			0	0
Reduced v/c Ratio	0.27	0.79		0.09	1.00			0.15			0.61	0.07

Intersection Summary

Area Type: Other
 Cycle Length: 95
 Actuated Cycle Length: 90.5
 Natural Cycle: 95
 Control Type: Actuated-Uncoordinated
 Maximum v/c Ratio: 0.93
 Intersection Signal Delay: 29.4 Intersection LOS: C
 Intersection Capacity Utilization 53.2% ICU Level of Service A
 Analysis Period (min) 15
 # 95th percentile volume exceeds capacity, queue may be longer.

Lanes, Volumes, Timings
 5: 6th & Brownell

11/22/2022

Queue shown is maximum after two cycles.

m Volume for 95th percentile queue is metered by upstream signal.

Splits and Phases: 5: 6th & Brownell

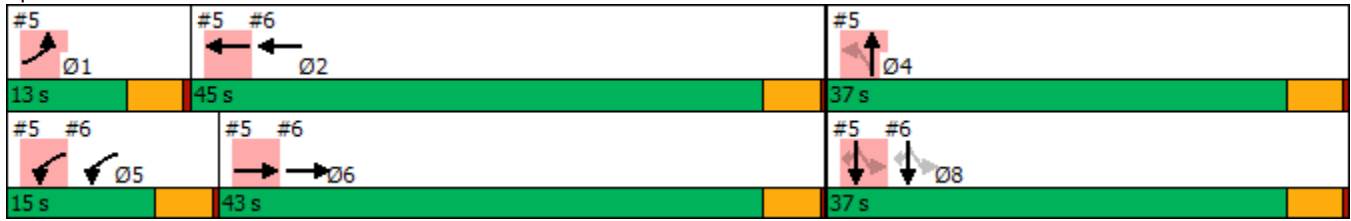

Lanes, Volumes, Timings

6: I-82 SB Entrance Ramp/I-82 SB Exit Ramp & 6th

11/22/2022



Lane Group	EBL	EBT	EBR	WBL	WBT	WBR	NBL	NBT	NBR	SBL	SBT	SBR
Lane Configurations		↑↑		↖	↑						↖	↖
Traffic Volume (vph)	0	900	150	90	610	0	0	0	0	425	5	465
Future Volume (vph)	0	900	150	90	610	0	0	0	0	425	5	465
Ideal Flow (vphpl)	1900	1900	1900	1900	1900	1900	1900	1900	1900	1900	1900	1900
Lane Width (ft)	12	12	12	12	12	12	12	12	12	12	12	12
Grade (%)		0%			0%			0%			0%	
Storage Length (ft)	0		0	125		0	0		0	0		0
Storage Lanes	0		0	1		0	0		0	0		1
Taper Length (ft)	25			45			25			25		
Lane Util. Factor	1.00	0.95	0.95	1.00	1.00	1.00	1.00	1.00	1.00	1.00	1.00	1.00
Ped Bike Factor												
Frt		0.979										0.850
Flt Protected				0.950							0.953	
Satd. Flow (prot)	0	3047	0	1687	1776	0	0	0	0	0	1548	1380
Flt Permitted				0.950							0.953	
Satd. Flow (perm)	0	3047	0	1687	1776	0	0	0	0	0	1548	1380
Right Turn on Red			Yes			Yes			Yes			Yes
Satd. Flow (RTOR)		24										310
Link Speed (mph)		35			35			45				45
Link Distance (ft)		236			481			189				496
Travel Time (s)		4.6			9.4			2.9				7.5
Confl. Peds. (#/hr)												
Confl. Bikes (#/hr)												
Peak Hour Factor	0.85	0.85	0.85	0.91	0.91	0.91	0.92	0.92	0.92	0.93	0.93	0.93
Growth Factor	100%	100%	100%	100%	100%	100%	100%	100%	100%	100%	100%	100%
Heavy Vehicles (%)	16%	16%	16%	7%	7%	7%	2%	2%	2%	17%	17%	17%
Bus Blockages (#/hr)	0	0	0	0	0	0	0	0	0	0	0	0
Parking (#/hr)												
Mid-Block Traffic (%)		0%			0%			0%			0%	
Adj. Flow (vph)	0	1059	176	99	670	0	0	0	0	457	5	500
Shared Lane Traffic (%)												
Lane Group Flow (vph)	0	1235	0	99	670	0	0	0	0	0	462	500
Enter Blocked Intersection	No	No	No	No	No	No	No	No	No	No	No	No
Lane Alignment	Left	Left	Left	R NA	R NA	R NA	Left	Left	Right	Left	Left	Right
Median Width(ft)		0			12			0			0	
Link Offset(ft)		0			0			0			0	
Crosswalk Width(ft)		16			16			16			16	
Two way Left Turn Lane												
Headway Factor	1.00	1.00	1.00	1.00	1.00	1.00	1.00	1.00	1.00	1.00	1.00	1.00
Turning Speed (mph)	15		9	15		9	15		9	15		9
Number of Detectors		2		1	2					1	2	1
Detector Template		Thru		Left	Thru					Left	Thru	Right
Leading Detector (ft)		100		20	100					20	100	20
Trailing Detector (ft)		0		0	0					0	0	0
Turn Type		NA		Prot	NA					Perm	NA	Perm
Protected Phases		6		5	2						8	
Permitted Phases										8		8
Detector Phase		6		5	2					8	8	8
Switch Phase												

Lanes, Volumes, Timings

6: I-82 SB Entrance Ramp/I-82 SB Exit Ramp & 6th

11/22/2022

Lane Group	Ø1	Ø4
Lane Configurations		
Traffic Volume (vph)		
Future Volume (vph)		
Ideal Flow (vphpl)		
Lane Width (ft)		
Grade (%)		
Storage Length (ft)		
Storage Lanes		
Taper Length (ft)		
Lane Util. Factor		
Ped Bike Factor		
Frt		
Flt Protected		
Satd. Flow (prot)		
Flt Permitted		
Satd. Flow (perm)		
Right Turn on Red		
Satd. Flow (RTOR)		
Link Speed (mph)		
Link Distance (ft)		
Travel Time (s)		
Confl. Peds. (#/hr)		
Confl. Bikes (#/hr)		
Peak Hour Factor		
Growth Factor		
Heavy Vehicles (%)		
Bus Blockages (#/hr)		
Parking (#/hr)		
Mid-Block Traffic (%)		
Adj. Flow (vph)		
Shared Lane Traffic (%)		
Lane Group Flow (vph)		
Enter Blocked Intersection		
Lane Alignment		
Median Width(ft)		
Link Offset(ft)		
Crosswalk Width(ft)		
Two way Left Turn Lane		
Headway Factor		
Turning Speed (mph)		
Number of Detectors		
Detector Template		
Leading Detector (ft)		
Trailing Detector (ft)		
Turn Type		
Protected Phases	1	4
Permitted Phases		
Detector Phase		
Switch Phase		

Lanes, Volumes, Timings
6: I-82 SB Entrance Ramp/I-82 SB Exit Ramp & 6th

11/22/2022



Lane Group	EBL	EBT	EBR	WBL	WBT	WBR	NBL	NBT	NBR	SBL	SBT	SBR
Minimum Initial (s)		10.0		7.0	10.0					7.0	7.0	7.0
Minimum Split (s)		40.5		13.0	36.5					37.0	37.0	37.0
Total Split (s)		43.0		15.0	45.0					37.0	37.0	37.0
Total Split (%)		45.3%		15.8%	47.4%					38.9%	38.9%	38.9%
Maximum Green (s)		38.5		10.5	40.5					32.5	32.5	32.5
Yellow Time (s)		4.0		4.0	4.0					4.0	4.0	4.0
All-Red Time (s)		0.5		0.5	0.5					0.5	0.5	0.5
Lost Time Adjust (s)		0.0		0.0	0.0						0.0	0.0
Total Lost Time (s)		4.5		4.5	4.5						4.5	4.5
Lead/Lag		Lag		Lead	Lag							
Lead-Lag Optimize?		Yes		Yes	Yes							
Vehicle Extension (s)		5.6		3.5	4.6					5.0	5.0	5.0
Minimum Gap (s)		3.6		2.0	2.6					5.0	5.0	5.0
Time Before Reduce (s)		10.0		10.0	10.0					5.0	5.0	5.0
Time To Reduce (s)		10.0		10.0	10.0					5.0	5.0	5.0
Recall Mode		Min		None	Min					None	None	None
Walk Time (s)		7.0			7.0					7.0	7.0	7.0
Flash Dont Walk (s)		29.0			22.0					25.0	25.0	25.0
Pedestrian Calls (#/hr)		0			0					0	0	0
Act Effct Green (s)		38.9		9.6	42.8						31.2	31.2
Actuated g/C Ratio		0.43		0.11	0.47						0.34	0.34
v/c Ratio		0.93		0.56	0.80						0.87	0.74
Control Delay		23.6		52.6	31.2						47.0	17.5
Queue Delay		0.0		0.0	3.5						0.0	0.9
Total Delay		23.7		52.6	34.7						47.0	18.4
LOS		C		D	C						D	B
Approach Delay		23.7			37.0						32.1	
Approach LOS		C			D						C	
Queue Length 50th (ft)		87		57	361						258	97
Queue Length 95th (ft)		#458		110	#582						#439	231
Internal Link Dist (ft)		156			401			109			416	
Turn Bay Length (ft)				125								
Base Capacity (vph)		1324		197	849						562	698
Starvation Cap Reductn		1		0	90						0	0
Spillback Cap Reductn		0		0	105						0	54
Storage Cap Reductn		0		0	0						0	0
Reduced v/c Ratio		0.93		0.50	0.90						0.82	0.78

Intersection Summary

Area Type:	Other
Cycle Length:	95
Actuated Cycle Length:	90.5
Natural Cycle:	95
Control Type:	Actuated-Uncoordinated
Maximum v/c Ratio:	0.93
Intersection Signal Delay:	29.9
Intersection LOS:	C
Intersection Capacity Utilization:	70.6%
ICU Level of Service:	C
Analysis Period (min):	15
# 95th percentile volume exceeds capacity, queue may be longer.	

Lanes, Volumes, Timings

6: I-82 SB Entrance Ramp/I-82 SB Exit Ramp & 6th

11/22/2022

Lane Group	Ø1	Ø4
Minimum Initial (s)	7.0	7.0
Minimum Split (s)	13.0	36.5
Total Split (s)	13.0	37.0
Total Split (%)	14%	39%
Maximum Green (s)	8.5	32.5
Yellow Time (s)	4.0	4.0
All-Red Time (s)	0.5	0.5
Lost Time Adjust (s)		
Total Lost Time (s)		
Lead/Lag	Lead	
Lead-Lag Optimize?	Yes	
Vehicle Extension (s)	3.5	3.5
Minimum Gap (s)	2.0	2.0
Time Before Reduce (s)	10.0	15.0
Time To Reduce (s)	10.0	15.0
Recall Mode	None	None
Walk Time (s)		7.0
Flash Dont Walk (s)		23.0
Pedestrian Calls (#/hr)		0
Act Effct Green (s)		
Actuated g/C Ratio		
v/c Ratio		
Control Delay		
Queue Delay		
Total Delay		
LOS		
Approach Delay		
Approach LOS		
Queue Length 50th (ft)		
Queue Length 95th (ft)		
Internal Link Dist (ft)		
Turn Bay Length (ft)		
Base Capacity (vph)		
Starvation Cap Reductn		
Spillback Cap Reductn		
Storage Cap Reductn		
Reduced v/c Ratio		
Intersection Summary		

Lanes, Volumes, Timings
 6: I-82 SB Entrance Ramp/I-82 SB Exit Ramp & 6th

11/22/2022

Queue shown is maximum after two cycles.

Splits and Phases: 6: I-82 SB Entrance Ramp/I-82 SB Exit Ramp & 6th

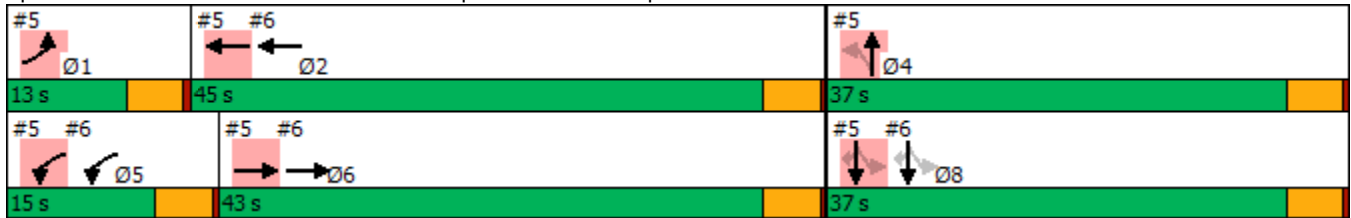

Lanes, Volumes, Timings

7: I-82 NB Exit Ramp/I-82 NB Entrance Ramp & 6th

11/22/2022

Lane Group	EBL	EBT	EBR	WBL	WBT	WBR	NBL	NBT	NBR	SBL	SBT	SBR
Lane Configurations												
Traffic Volume (vph)	415	910	0	0	660	645	40	5	170	0	0	0
Future Volume (vph)	415	910	0	0	660	645	40	5	170	0	0	0
Ideal Flow (vphpl)	1900	1900	1900	1900	1900	1900	1900	1900	1900	1900	1900	1900
Lane Width (ft)	12	12	12	12	12	12	12	12	12	12	12	12
Grade (%)		0%			0%			0%			0%	
Storage Length (ft)	250		0	0		0	0		215	0		0
Storage Lanes	1		0	0		1	0		1	0		0
Taper Length (ft)	45			25			25			25		
Lane Util. Factor	0.97	0.95	1.00	1.00	1.00	1.00	1.00	1.00	1.00	1.00	1.00	1.00
Ped Bike Factor												
Flt						0.850			0.850			
Flt Protected	0.950							0.957				
Satd. Flow (prot)	3335	3438	0	0	1810	1538	0	1478	1313	0	0	0
Flt Permitted	0.950							0.957				
Satd. Flow (perm)	3335	3438	0	0	1810	1538	0	1478	1313	0	0	0
Right Turn on Red			Yes			Yes			Yes			Yes
Satd. Flow (RTOR)						551			132			
Link Speed (mph)		35			45			45			45	
Link Distance (ft)		481			3338			681			572	
Travel Time (s)		9.4			50.6			10.3			8.7	
Confl. Peds. (#/hr)												
Confl. Bikes (#/hr)												
Peak Hour Factor	0.80	0.80	0.80	0.85	0.85	0.85	0.82	0.82	0.82	0.92	0.92	0.92
Growth Factor	100%	100%	100%	100%	100%	100%	100%	100%	100%	100%	100%	100%
Heavy Vehicles (%)	5%	5%	5%	5%	5%	5%	23%	23%	23%	2%	2%	2%
Bus Blockages (#/hr)	0	0	0	0	0	0	0	0	0	0	0	0
Parking (#/hr)												
Mid-Block Traffic (%)		0%			0%			0%			0%	
Adj. Flow (vph)	519	1138	0	0	776	759	49	6	207	0	0	0
Shared Lane Traffic (%)												
Lane Group Flow (vph)	519	1138	0	0	776	759	0	55	207	0	0	0
Enter Blocked Intersection	No	No	No	No	No	No	No	No	No	No	No	No
Lane Alignment	Left	Left	Right	Left	Left	Right	Left	Left	Right	Left	Left	Right
Median Width(ft)		24			24			0			0	
Link Offset(ft)		0			0			0			0	
Crosswalk Width(ft)		16			16			16			16	
Two way Left Turn Lane												
Headway Factor	1.00	1.00	1.00	1.00	1.00	1.00	1.00	1.00	1.00	1.00	1.00	1.00
Turning Speed (mph)	15		9	15		9	15		9	15		9
Number of Detectors	1	2			2	1	1	2	1			
Detector Template	Left	Thru			Thru	Right	Left	Thru	Right			
Leading Detector (ft)	20	100			100	20	20	100	20			
Trailing Detector (ft)	0	0			0	0	0	0	0			
Turn Type	Prot	NA			NA	Perm	Perm	NA	Perm			
Protected Phases	7	4			8			2				
Permitted Phases						8	2		2			
Detector Phase	7	4			8	8	2	2	2			
Switch Phase												

Lanes, Volumes, Timings

7: I-82 NB Exit Ramp/I-82 NB Entrance Ramp & 6th

11/22/2022



Lane Group	EBL	EBT	EBR	WBL	WBT	WBR	NBL	NBT	NBR	SBL	SBT	SBR
Minimum Initial (s)	5.0	5.0			5.0	5.0	5.0	5.0	5.0			
Minimum Split (s)	9.5	22.5			22.5	22.5	22.5	22.5	22.5			
Total Split (s)	22.0	72.0			50.0	50.0	23.0	23.0	23.0			
Total Split (%)	23.2%	75.8%			52.6%	52.6%	24.2%	24.2%	24.2%			
Maximum Green (s)	17.5	67.5			45.5	45.5	18.5	18.5	18.5			
Yellow Time (s)	3.5	3.5			3.5	3.5	3.5	3.5	3.5			
All-Red Time (s)	1.0	1.0			1.0	1.0	1.0	1.0	1.0			
Lost Time Adjust (s)	0.0	0.0			0.0	0.0		0.0	0.0			
Total Lost Time (s)	4.5	4.5			4.5	4.5		4.5	4.5			
Lead/Lag	Lead				Lag				Lag			
Lead-Lag Optimize?	Yes				Yes				Yes			
Vehicle Extension (s)	3.0	3.0			3.0	3.0	3.0	3.0	3.0			
Minimum Gap (s)	3.0	3.0			3.0	3.0	3.0	3.0	3.0			
Time Before Reduce (s)	0.0	0.0			0.0	0.0	0.0	0.0	0.0			
Time To Reduce (s)	0.0	0.0			0.0	0.0	0.0	0.0	0.0			
Recall Mode	None	None			None	None	C-Max	C-Max	C-Max			
Walk Time (s)		7.0			7.0	7.0	7.0	7.0	7.0			
Flash Dont Walk (s)		11.0			11.0	11.0	11.0	11.0	11.0			
Pedestrian Calls (#/hr)		0			0	0	0	0	0			
Act Effct Green (s)	17.1	66.0			44.4	44.4		20.0	20.0			
Actuated g/C Ratio	0.18	0.69			0.47	0.47		0.21	0.21			
v/c Ratio	0.87	0.48			0.92	0.75		0.18	0.54			
Control Delay	54.0	7.2			40.9	10.4		33.9	19.5			
Queue Delay	0.0	0.5			0.0	0.0		0.0	0.0			
Total Delay	54.0	7.8			40.9	10.4		33.9	19.5			
LOS	D	A			D	B		C	B			
Approach Delay		22.2			25.9			22.5				
Approach LOS		C			C			C				
Queue Length 50th (ft)	157	134			411	79		28	39			
Queue Length 95th (ft)	187	142			#589	181		56	92			
Internal Link Dist (ft)		401			3258			601			492	
Turn Bay Length (ft)	250								215			
Base Capacity (vph)	614	2442			866	1023		310	380			
Starvation Cap Reductn	0	791			0	0		0	0			
Spillback Cap Reductn	0	0			0	0		0	0			
Storage Cap Reductn	0	0			0	0		0	0			
Reduced v/c Ratio	0.85	0.69			0.90	0.74		0.18	0.54			

Intersection Summary

Area Type:	Other
Cycle Length:	95
Actuated Cycle Length:	95
Offset:	0 (0%), Referenced to phase 2:NBTL and 6:, Start of Green
Natural Cycle:	90
Control Type:	Actuated-Coordinated
Maximum v/c Ratio:	0.92
Intersection Signal Delay:	23.9
Intersection LOS:	C
Intersection Capacity Utilization:	70.6%
ICU Level of Service:	C
Analysis Period (min):	15

Lanes, Volumes, Timings

7: I-82 NB Exit Ramp/I-82 NB Entrance Ramp & 6th

11/22/2022

95th percentile volume exceeds capacity, queue may be longer.
 Queue shown is maximum after two cycles.

Splits and Phases: 7: I-82 NB Exit Ramp/I-82 NB Entrance Ramp & 6th

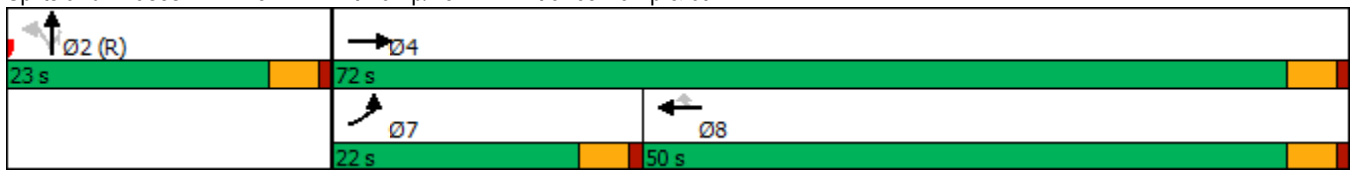

Lanes, Volumes, Timings

8: Devore & 6th

11/22/2022

Lane Group	EBL	EBT	EBR	WBL	WBT	WBR	NBL	NBT	NBR	SBL	SBT	SBR
Lane Configurations												
Traffic Volume (vph)	10	380	0	420	690	10	625	15	335	10	20	55
Future Volume (vph)	10	380	0	420	690	10	625	15	335	10	20	55
Ideal Flow (vphpl)	1900	1900	1900	1900	1900	1900	1900	1900	1900	1900	1900	1900
Lane Width (ft)	12	12	12	12	12	12	12	12	12	12	12	12
Grade (%)		0%			0%			0%			0%	
Storage Length (ft)	125		0	250		0	0		0	0		0
Storage Lanes	1		0	2		0	2		0	0		0
Taper Length (ft)	60			88			25			25		
Lane Util. Factor	1.00	0.95	1.00	0.97	0.95	0.95	0.97	1.00	1.00	1.00	1.00	1.00
Ped Bike Factor												
Flt					0.998			0.857				0.913
Flt Protected	0.950			0.950			0.950					0.994
Satd. Flow (prot)	1770	3539	0	3433	3532	0	3433	1596	0	0	1690	0
Flt Permitted	0.950			0.950			0.950					0.910
Satd. Flow (perm)	1770	3539	0	3433	3532	0	3433	1596	0	0	1548	0
Right Turn on Red			Yes			Yes			Yes			Yes
Satd. Flow (RTOR)					1			372				67
Link Speed (mph)		45			45			45				45
Link Distance (ft)		343			889			455				382
Travel Time (s)		5.2			13.5			6.9				5.8
Confl. Peds. (#/hr)												
Confl. Bikes (#/hr)												
Peak Hour Factor	0.82	0.82	0.82	0.72	0.72	0.72	0.90	0.90	0.90	0.42	0.42	0.42
Growth Factor	100%	100%	100%	100%	100%	100%	100%	100%	100%	100%	100%	100%
Heavy Vehicles (%)	2%	2%	2%	2%	2%	2%	2%	2%	2%	2%	2%	2%
Bus Blockages (#/hr)	0	0	0	0	0	0	0	0	0	0	0	0
Parking (#/hr)												
Mid-Block Traffic (%)		0%			0%			0%				0%
Adj. Flow (vph)	12	463	0	583	958	14	694	17	372	24	48	131
Shared Lane Traffic (%)												
Lane Group Flow (vph)	12	463	0	583	972	0	694	389	0	0	203	0
Enter Blocked Intersection	No	No	No	No	No	No	No	No	No	No	No	No
Lane Alignment	Left	Left	Right	Left	Left	Right	Left	Left	Right	Left	Left	Right
Median Width(ft)		24			24			24				24
Link Offset(ft)		0			0			0				0
Crosswalk Width(ft)		16			16			16				16
Two way Left Turn Lane												
Headway Factor	1.00	1.00	1.00	1.00	1.00	1.00	1.00	1.00	1.00	1.00	1.00	1.00
Turning Speed (mph)	15		9	15		9	15		9	15		9
Number of Detectors	1	2		1	2		1	2		1	2	
Detector Template	Left	Thru		Left	Thru		Left	Thru		Left	Thru	
Leading Detector (ft)	20	100		20	100		20	100		20	100	
Trailing Detector (ft)	0	0		0	0		0	0		0	0	
Turn Type	Prot	NA		Prot	NA		Prot	NA		Perm	NA	
Protected Phases	5	2		1	6		3	8				4
Permitted Phases										4		
Detector Phase	5	2		1	6		3	8		4		4
Switch Phase												

Lanes, Volumes, Timings
8: Devore & 6th

11/22/2022



Lane Group	EBL	EBT	EBR	WBL	WBT	WBR	NBL	NBT	NBR	SBL	SBT	SBR
Minimum Initial (s)	8.0	10.0		8.0	10.0		5.0	8.0		7.0	7.0	
Minimum Split (s)	13.0	36.5		13.0	31.5		9.5	46.5		36.5	36.5	
Total Split (s)	13.0	37.0		26.0	50.0		30.5	67.0		36.5	36.5	
Total Split (%)	10.0%	28.5%		20.0%	38.5%		23.5%	51.5%		28.1%	28.1%	
Maximum Green (s)	8.5	31.5		21.5	44.5		26.0	61.5		32.0	32.0	
Yellow Time (s)	4.0	5.0		4.0	5.0		3.5	5.0		4.0	4.0	
All-Red Time (s)	0.5	0.5		0.5	0.5		1.0	0.5		0.5	0.5	
Lost Time Adjust (s)	0.0	0.0		0.0	0.0		0.0	0.0			0.0	
Total Lost Time (s)	4.5	5.5		4.5	5.5		4.5	5.5			4.5	
Lead/Lag	Lead	Lag		Lead	Lag		Lead			Lag	Lag	
Lead-Lag Optimize?	Yes	Yes		Yes	Yes		Yes			Yes	Yes	
Vehicle Extension (s)	2.5	7.0		3.5	5.4		3.0	3.5		2.5	2.5	
Minimum Gap (s)	1.0	3.4		2.5	3.4		3.0	1.5		1.0	1.0	
Time Before Reduce (s)	5.0	15.0		5.0	15.0		0.0	10.0		5.0	5.0	
Time To Reduce (s)	5.0	15.0		5.0	15.0		0.0	10.0		5.0	5.0	
Recall Mode	None	Min		None	Min		None	None		None	None	
Walk Time (s)		7.0			7.0			7.0		7.0	7.0	
Flash Dont Walk (s)		24.0			19.0			34.0		25.0	25.0	
Pedestrian Calls (#/hr)		0			0			0		0	0	
Act Effct Green (s)	8.1	23.5		21.7	47.6		26.2	44.3			14.5	
Actuated g/C Ratio	0.08	0.22		0.21	0.45		0.25	0.42			0.14	
v/c Ratio	0.09	0.59		0.82	0.61		0.81	0.44			0.75	
Control Delay	51.4	40.1		52.1	25.2		47.1	4.2			46.5	
Queue Delay	0.0	0.0		0.0	0.0		0.0	0.0			0.0	
Total Delay	51.4	40.1		52.1	25.2		47.1	4.2			46.5	
LOS	D	D		D	C		D	A			D	
Approach Delay		40.4			35.3			31.7			46.5	
Approach LOS		D			D			C			D	
Queue Length 50th (ft)	7	145		189	238		220	6			87	
Queue Length 95th (ft)	26	194		231	310		#391	65			48	
Internal Link Dist (ft)		263			809			375			302	
Turn Bay Length (ft)	125			250								
Base Capacity (vph)	144	1070		708	1602		856	1094			521	
Starvation Cap Reductn	0	0		0	0		0	0			0	
Spillback Cap Reductn	0	0		0	0		0	0			0	
Storage Cap Reductn	0	0		0	0		0	0			0	
Reduced v/c Ratio	0.08	0.43		0.82	0.61		0.81	0.36			0.39	

Intersection Summary

Area Type: Other
 Cycle Length: 130
 Actuated Cycle Length: 105.1
 Natural Cycle: 130
 Control Type: Actuated-Uncoordinated
 Maximum v/c Ratio: 0.82
 Intersection Signal Delay: 35.6
 Intersection LOS: D
 Intersection Capacity Utilization 63.5%
 ICU Level of Service B
 Analysis Period (min) 15
 # 95th percentile volume exceeds capacity, queue may be longer.

Queue shown is maximum after two cycles.

Splits and Phases: 8: Devore & 6th

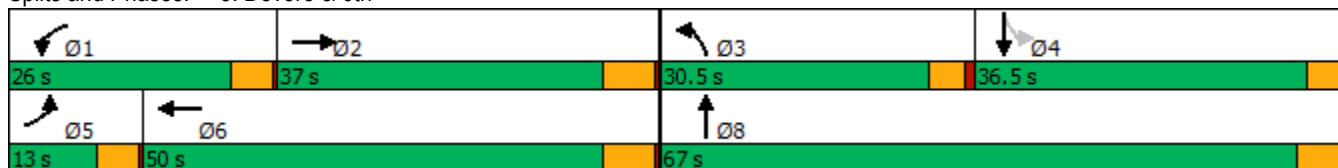

HCS7 Two-Way Stop-Control Report

General Information				Site Information			
Analyst	Montgomery	Intersection	Columbia Blvd/US 730				
Agency/Co.	JUB Engineers	Jurisdiction	City of Umatilla				
Date Performed	9/30/2022	East/West Street	6th Street (US 730)				
Analysis Year	2043	North/South Street	Columbia Blvd				
Time Analyzed	PM Peak Hour - Mitigated	Peak Hour Factor	0.81				
Intersection Orientation	East-West	Analysis Time Period (hrs)	0.25				
Project Description	Umatilla Transportation System Plan						

Lanes

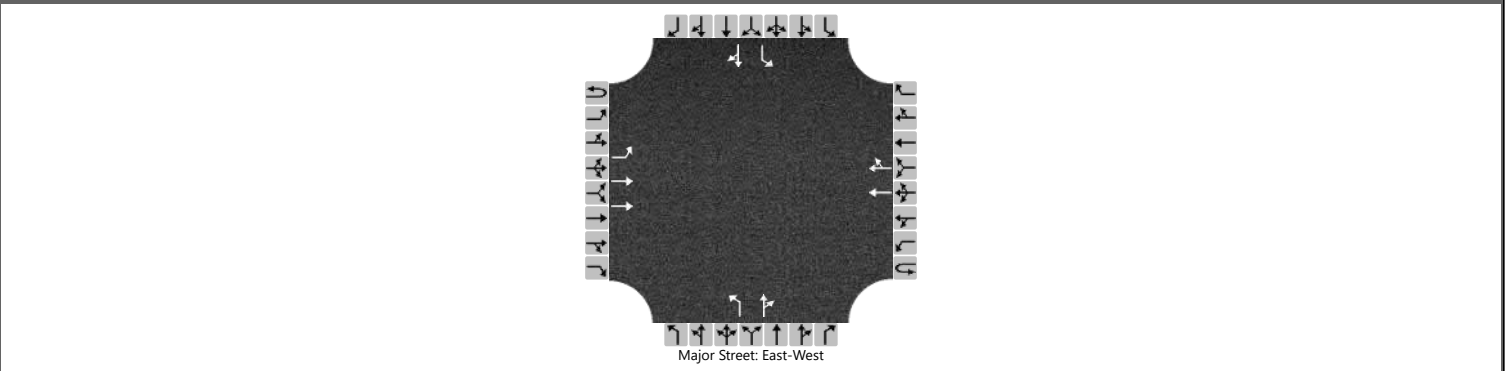

Vehicle Volumes and Adjustments

Approach	Eastbound				Westbound				Northbound				Southbound			
	U	L	T	R	U	L	T	R	U	L	T	R	U	L	T	R
Movement	1U	1	2	3	4U	4	5	6		7	8	9		10	11	12
Priority																
Number of Lanes	0	1	2	0	0	0	2	0		1	1	0		1	1	0
Configuration		L	T				T	TR		L		TR		L		TR
Volume (veh/h)	0	200	475				1010	30		0	0	0		15	0	140
Percent Heavy Vehicles (%)	3	3								3	3	3		3	3	3
Proportion Time Blocked																
Percent Grade (%)									0				0			
Right Turn Channelized																
Median Type Storage					Left Only								1			

Critical and Follow-up Headways

Base Critical Headway (sec)		4.1								7.5	6.5	6.9		7.5	6.5	6.9
Critical Headway (sec)		4.16								7.56	6.56	6.96		7.56	6.56	6.96
Base Follow-Up Headway (sec)		2.2								3.5	4.0	3.3		3.5	4.0	3.3
Follow-Up Headway (sec)		2.23								3.53	4.03	3.33		3.53	4.03	3.33

Delay, Queue Length, and Level of Service

Flow Rate, v (veh/h)		247								0		0		19		173	
Capacity, c (veh/h)		531								6				92		414	
v/c Ratio		0.47								0.00				0.20		0.42	
95% Queue Length, Q ₉₅ (veh)		2.4								0.0				0.7		2.0	
Control Delay (s/veh)		17.5								646.7				53.6		19.8	
Level of Service (LOS)		C								F				F		C	
Approach Delay (s/veh)		5.2												23.0			
Approach LOS														C			

HCS7 Two-Way Stop-Control Report

General Information		Site Information	
Analyst	Montgomery	Intersection	Willamette/US 730
Agency/Co.	JUB Engineers	Jurisdiction	City of Umatilla
Date Performed	9/30/2022	East/West Street	6th Street (US 730)
Analysis Year	2043	North/South Street	Willamette St
Time Analyzed	PM Pk Hr - Mitigated A	Peak Hour Factor	0.83
Intersection Orientation	East-West	Analysis Time Period (hrs)	0.25
Project Description	Umatilla Transportation System Plan		

Lanes

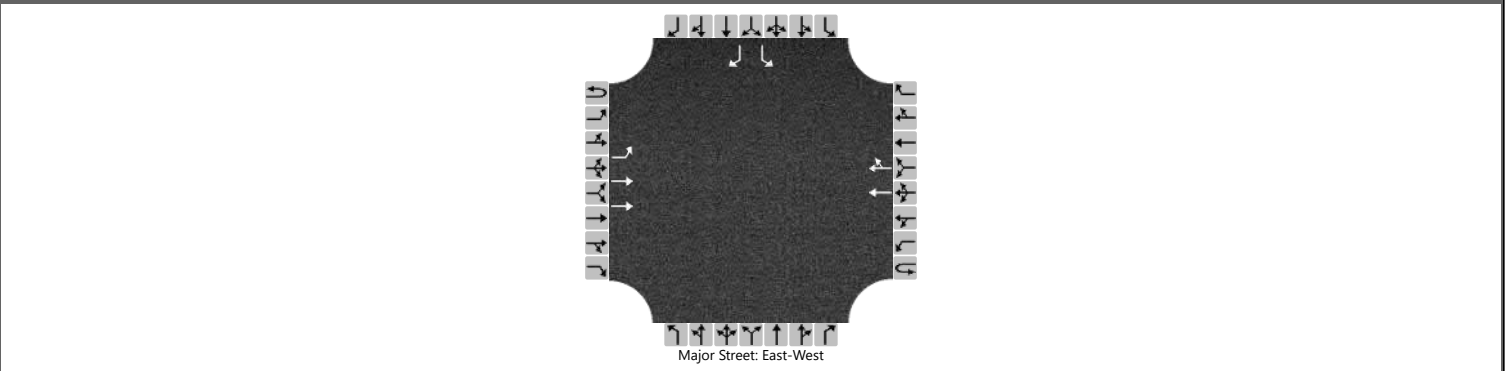

Vehicle Volumes and Adjustments

Approach	Eastbound				Westbound				Northbound				Southbound			
	U	L	T	R	U	L	T	R	U	L	T	R	U	L	T	R
Movement	1U	1	2	3	4U	4	5	6		7	8	9		10	11	12
Priority																
Number of Lanes	0	1	2	0	0	0	2	0	0	0	0	0	1	0	1	
Configuration		L	T				T	TR					L		R	
Volume (veh/h)	0	425	270				840	170					40		200	
Percent Heavy Vehicles (%)	3	3											3		3	
Proportion Time Blocked																
Percent Grade (%)													0			
Right Turn Channelized													No			
Median Type Storage					Left Only								1			

Critical and Follow-up Headways

Base Critical Headway (sec)		4.1												7.5		6.9
Critical Headway (sec)		4.16												6.86		6.96
Base Follow-Up Headway (sec)		2.2												3.5		3.3
Follow-Up Headway (sec)		2.23												3.53		3.33

Delay, Queue Length, and Level of Service

Flow Rate, v (veh/h)		512												48		241	
Capacity, c (veh/h)		563												20		436	
v/c Ratio		0.91												2.47		0.55	
95% Queue Length, Q ₉₅ (veh)		11.0												6.4		3.3	
Control Delay (s/veh)		46.0												1079.1		23.0	
Level of Service (LOS)		E												F		C	
Approach Delay (s/veh)		28.1												199.0			
Approach LOS														F			

HCS7 Two-Way Stop-Control Report

General Information		Site Information	
Analyst	Montgomery	Intersection	Willamette/US 730
Agency/Co.	JUB Engineers	Jurisdiction	City of Umatilla
Date Performed	9/30/2022	East/West Street	6th Street (US 730)
Analysis Year	2043	North/South Street	Willamette St
Time Analyzed	PM Pk Hr - Mit B, reduced	Peak Hour Factor	0.83
Intersection Orientation	East-West	Analysis Time Period (hrs)	0.25
Project Description	Umatilla Transportation System Plan		

Lanes

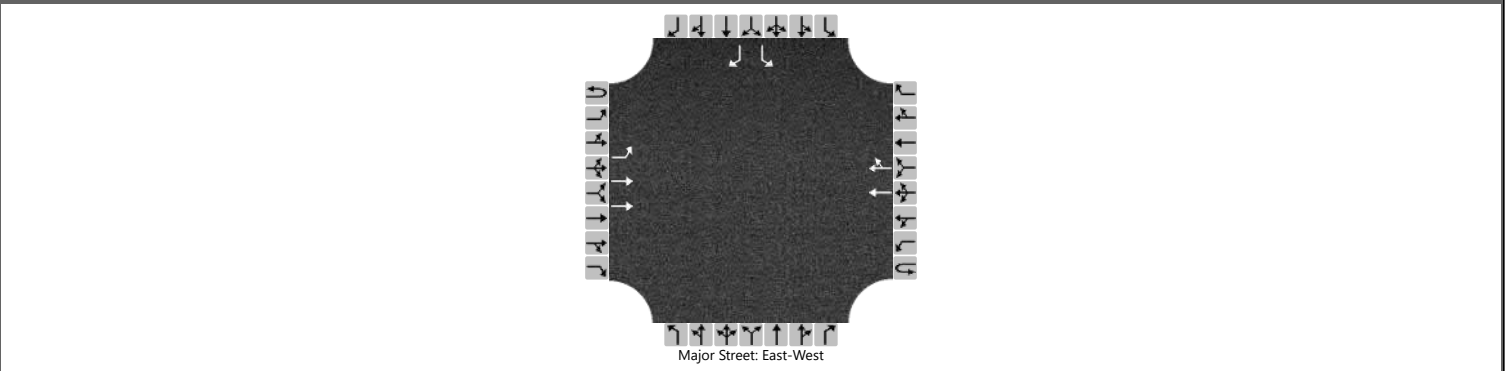

Vehicle Volumes and Adjustments

Approach	Eastbound				Westbound				Northbound				Southbound			
	U	L	T	R	U	L	T	R	U	L	T	R	U	L	T	R
Movement	1U	1	2	3	4U	4	5	6		7	8	9		10	11	12
Priority																
Number of Lanes	0	1	2	0	0	0	2	0	0	0	0	0	1	0	1	
Configuration		L	T				T	TR					L		R	
Volume (veh/h)	0	225	270				840	170					40		200	
Percent Heavy Vehicles (%)	3	3											3		3	
Proportion Time Blocked																
Percent Grade (%)													0			
Right Turn Channelized													No			
Median Type Storage					Left Only								1			

Critical and Follow-up Headways

Base Critical Headway (sec)		4.1												7.5		6.9
Critical Headway (sec)		4.16												6.86		6.96
Base Follow-Up Headway (sec)		2.2												3.5		3.3
Follow-Up Headway (sec)		2.23												3.53		3.33

Delay, Queue Length, and Level of Service

Flow Rate, v (veh/h)		271												48		241	
Capacity, c (veh/h)		563												131		436	
v/c Ratio		0.48												0.37		0.55	
95% Queue Length, Q ₉₅ (veh)		2.6												1.5		3.3	
Control Delay (s/veh)		17.2												47.8		23.0	
Level of Service (LOS)		C												E		C	
Approach Delay (s/veh)		7.8												27.1			
Approach LOS														D			

HCS7 Two-Way Stop-Control Report

General Information		Site Information	
Analyst	Montgomery	Intersection	Beach Access Rd/US 730
Agency/Co.	JUB Engineers	Jurisdiction	City of Umatilla
Date Performed	9/30/2022	East/West Street	6th Street (US 730)
Analysis Year	2043	North/South Street	Beach Access Rd
Time Analyzed	PM Peak Hour	Peak Hour Factor	0.79
Intersection Orientation	East-West	Analysis Time Period (hrs)	0.25
Project Description	Umatilla Transportation System Plan		

Lanes

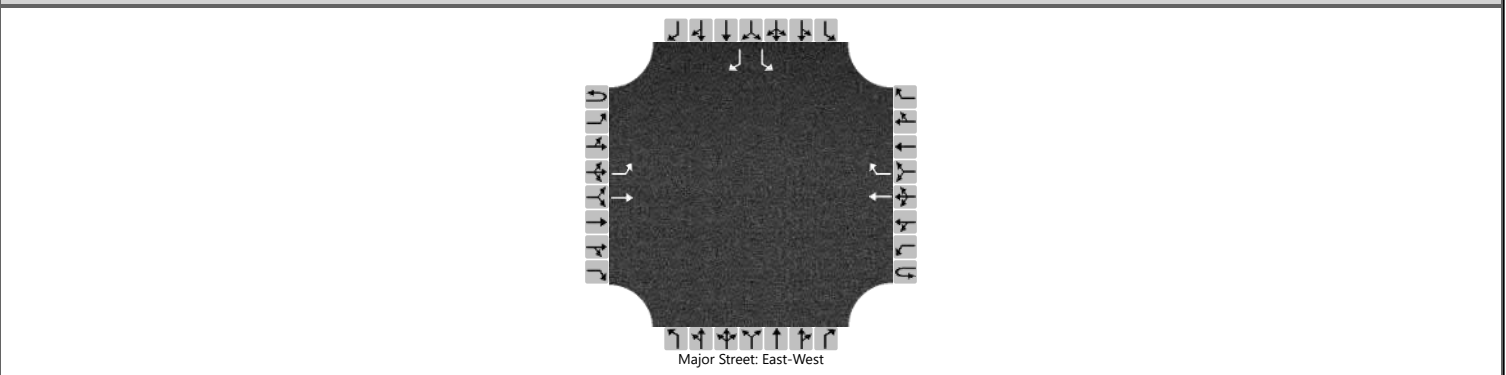

Vehicle Volumes and Adjustments

Approach	Eastbound				Westbound				Northbound				Southbound			
	U	L	T	R	U	L	T	R	U	L	T	R	U	L	T	R
Movement	1U	1	2	3	4U	4	5	6		7	8	9		10	11	12
Priority																
Number of Lanes	0	1	1	0	0	0	1	1		0	0	0		1	0	1
Configuration		L	T				T	R						L		R
Volume (veh/h)		70	240				180	15						135		750
Percent Heavy Vehicles (%)		3												3		3
Proportion Time Blocked																
Percent Grade (%)													0			
Right Turn Channelized					No								No			
Median Type Storage	Undivided															

Critical and Follow-up Headways

Base Critical Headway (sec)		4.1												7.1		6.2
Critical Headway (sec)		4.13												6.43		6.23
Base Follow-Up Headway (sec)		2.2												3.5		3.3
Follow-Up Headway (sec)		2.23												3.53		3.33

Delay, Queue Length, and Level of Service

Flow Rate, v (veh/h)		89												171		949
Capacity, c (veh/h)		1313												372		809
v/c Ratio		0.07												0.46		1.17
95% Queue Length, Q ₉₅ (veh)		0.2												2.3		29.6
Control Delay (s/veh)		7.9												22.6		110.8
Level of Service (LOS)		A												C		F
Approach Delay (s/veh)	1.8												97.3			
Approach LOS													F			

HCS7 Two-Way Stop-Control Report

General Information		Site Information	
Analyst	Montgomery	Intersection	Beach Access Rd/US 730
Agency/Co.	JUB Engineers	Jurisdiction	City of Umatilla
Date Performed	9/30/2022	East/West Street	6th Street (US 730)
Analysis Year	2043	North/South Street	Beach Access Rd
Time Analyzed	PM Pk Hr - Mitigated B	Peak Hour Factor	0.79
Intersection Orientation	East-West	Analysis Time Period (hrs)	0.25
Project Description	Umatilla Transportation System Plan		

Lanes

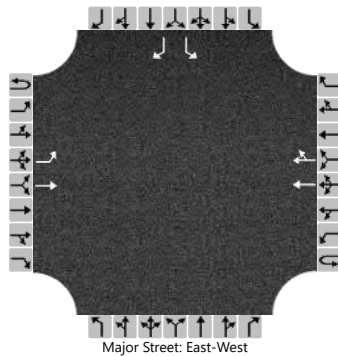

Vehicle Volumes and Adjustments

Approach	Eastbound				Westbound				Northbound				Southbound			
	U	L	T	R	U	L	T	R	U	L	T	R	U	L	T	R
Movement	1U	1	2	3	4U	4	5	6	7	8	9		10	11	12	
Priority																
Number of Lanes	0	1	1	0	0	0	2	0	0	0	0		1	0	1	
Configuration		L	T				T	TR					L		R	
Volume (veh/h)	0	70	240				180	15					135		750	
Percent Heavy Vehicles (%)	3	3											3		3	
Proportion Time Blocked																
Percent Grade (%)													0			
Right Turn Channelized													No			
Median Type Storage	Undivided															

Critical and Follow-up Headways

Base Critical Headway (sec)		4.1												7.5		6.9
Critical Headway (sec)		4.16												6.86		6.96
Base Follow-Up Headway (sec)		2.2												3.5		3.3
Follow-Up Headway (sec)		2.23												3.53		3.33

Delay, Queue Length, and Level of Service

Flow Rate, v (veh/h)		89												171		949
Capacity, c (veh/h)		1309												337		901
v/c Ratio		0.07												0.51		1.05
95% Queue Length, Q ₉₅ (veh)		0.2												2.7		22.1
Control Delay (s/veh)		8.0												26.2		66.2
Level of Service (LOS)		A												D		F
Approach Delay (s/veh)	1.8												60.1			
Approach LOS													F			

HCS7 Two-Way Stop-Control Report

General Information		Site Information	
Analyst	Montgomery	Intersection	Beach Access Rd/US 730
Agency/Co.	JUB Engineers	Jurisdiction	City of Umatilla
Date Performed	9/30/2022	East/West Street	6th Street (US 730)
Analysis Year	2043	North/South Street	Beach Access Rd
Time Analyzed	PM Pk Hr - Mitigated C	Peak Hour Factor	0.79
Intersection Orientation	East-West	Analysis Time Period (hrs)	0.25
Project Description	Umatilla Transportation System Plan		

Lanes

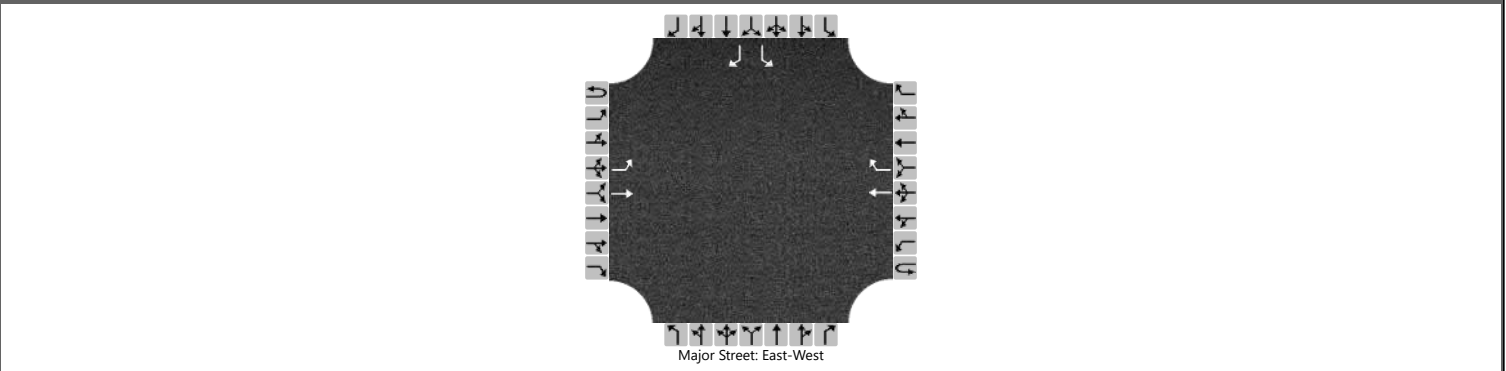

Vehicle Volumes and Adjustments

Approach	Eastbound				Westbound				Northbound				Southbound			
	U	L	T	R	U	L	T	R	U	L	T	R	U	L	T	R
Movement	1U	1	2	3	4U	4	5	6		7	8	9		10	11	12
Priority																
Number of Lanes	0	1	1	0	0	0	1	1		0	0	0		1	0	1
Configuration		L	T				T	R						L		R
Volume (veh/h)		70	240				180	15						135		0
Percent Heavy Vehicles (%)		3												3		3
Proportion Time Blocked																
Percent Grade (%)																0
Right Turn Channelized							No									No
Median Type Storage							Undivided									

Critical and Follow-up Headways

Base Critical Headway (sec)		4.1												7.1		6.2
Critical Headway (sec)		4.13												6.43		6.23
Base Follow-Up Headway (sec)		2.2												3.5		3.3
Follow-Up Headway (sec)		2.23												3.53		3.33

Delay, Queue Length, and Level of Service

Flow Rate, v (veh/h)		89												171		0	
Capacity, c (veh/h)		1313												372		809	
v/c Ratio		0.07												0.46		0.00	
95% Queue Length, Q ₉₅ (veh)		0.2												2.3		0.0	
Control Delay (s/veh)		7.9												22.6		9.5	
Level of Service (LOS)		A												C		A	
Approach Delay (s/veh)		1.8												22.6			
Approach LOS														C			

HCS7 Two-Way Stop-Control Report

General Information		Site Information	
Analyst	Montgomery	Intersection	Powerline/Madison
Agency/Co.	JUB Engineers	Jurisdiction	City of Umatilla
Date Performed	9/30/22	East/West Street	Madison Street
Analysis Year	2043	North/South Street	Powerline Road
Time Analyzed	PM Peak Hour	Peak Hour Factor	0.90
Intersection Orientation	North-South	Analysis Time Period (hrs)	0.25
Project Description	Umatilla Transportation System Plan		

Lanes

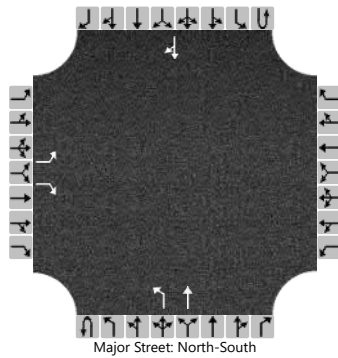

Vehicle Volumes and Adjustments

Approach	Eastbound				Westbound				Northbound				Southbound			
	U	L	T	R	U	L	T	R	U	L	T	R	U	L	T	R
Priority		10	11	12		7	8	9	1U	1	2	3	4U	4	5	6
Number of Lanes		1	0	1		0	0	0	0	1	1	0	0	0	1	0
Configuration		L		R						L	T					TR
Volume (veh/h)		100		20						25	485				430	150
Percent Heavy Vehicles (%)		3		3						3						
Proportion Time Blocked																
Percent Grade (%)		0														
Right Turn Channelized		No														
Median Type Storage		Left Only											1			

Critical and Follow-up Headways

Base Critical Headway (sec)		7.1		6.2						4.1						
Critical Headway (sec)		6.43		6.23						4.13						
Base Follow-Up Headway (sec)		3.5		3.3						2.2						
Follow-Up Headway (sec)		3.53		3.33						2.23						

Delay, Queue Length, and Level of Service

Flow Rate, v (veh/h)		111		22						28						
Capacity, c (veh/h)		347		525						936						
v/c Ratio		0.32		0.04						0.03						
95% Queue Length, Q ₉₅ (veh)		1.4		0.1						0.1						
Control Delay (s/veh)		20.2		12.2						9.0						
Level of Service (LOS)		C		B						A						
Approach Delay (s/veh)		18.9								0.4						
Approach LOS		C														

Appendix K
Interim Year Forecast Details and
Capacity Analysis Worksheets

Umatilla Transportation System Plan Update
PM Peak Period Turning Movement Volumes - US 730 Corridor
Intermediate Year Forecasts

Brownell/3rd (Intersection #1)

	Northbound			Southbound			Eastbound			Westbound			Total Volume	
	Left	Thru	Right	Left	Thru	Right	Left	Thru	Right	Left	Thru	Right	Hourly	
2022 May PM Peak Hour	37	0	21	0	0	0	0	21	24	14	19	0	136	
Existing PM Pk Hr w/Seasonal Adj	40	0	25	0	0	0	0	25	25	15	20	0	150	
2043 @1.5%/year	55	0	34	0	0	0	0	34	34	21	27	0	205	
2043 Forecast (rounded)	55	0	35	0	0	0	0	35	35	20	25	0	205	

Powerline/6th (US 730) (Intersection #2)

	Northbound			Southbound			Eastbound			Westbound			Total Volume	PHF
	Left	Thru	Right	Left	Thru	Right	Left	Thru	Right	Left	Thru	Right		
2022 May PM Peak Hour	48	0	103	0	0	0	381	65	147	302	0	1046		
Existing PM Pk Hr w/Seasonal Adj	55	0	115	0	0	0	425	75	165	340	0	1175	0.94	
2043 Forecast (rnd&bal)	240	0	345	0	0	0	455	230	475	390	0	2135		
2028	110	0	180	0	0	0	435	120	255	355	0	1455		
2033	150	0	235	0	0	0	440	155	325	365	0	1670		
2038	195	0	290	0	0	0	450	195	400	380	0	1910		

Switzler/6th (US 730) (Intersection #3)

	Left	Thru	Right	Left	Thru	Right	Left	Thru	Right	Left	Thru	Right	Total Volume	PHF
Existing PM Pk Hr w/Seasonal Adj	10	2	15	20	1	15	20	545	10	30	480	25	1173	0.92
2043 Forecast (rnd&bal)	15	5	25	25	2	25	30	770	15	40	825	35	1812	
2028	10	5	20	20	1	20	25	610	10	35	580	30	1366	
2033	15	5	20	25	2	20	25	665	15	35	660	30	1517	
2038	15	5	25	25	2	25	30	715	15	40	745	35	1677	

Umatilla River Road (County Road 1275)/6th (US 730) (Intersection #4)

	Northbound			Southbound			Eastbound			Westbound			Total Volume	PHF
	Left	Thru	Right	Left	Thru	Right	Left	Thru	Right	Left	Thru	Right		
2022 May PM Peak Hour	111	0	82	0	0	0	0	431	138	94	408	0	1264	
Existing PM Pk Hr w/Seasonal Adj	125	0	90	0	0	0	0	485	155	105	455	0	1415	0.92
2043 Forecast (rnd&bal)	185	0	125	0	0	0	0	665	210	145	750	0	2080	
2028	140	0	100	0	0	0	0	535	170	115	540	0	1600	
2033	155	0	110	0	0	0	0	580	185	125	610	0	1765	
2038	170	0	115	0	0	0	0	620	195	135	680	0	1915	

Brownelle/6th (US 730) (Intersection #5)

	Northbound			Southbound			Eastbound			Westbound			Total Volume	PHF
	Left	Thru	Right	Left	Thru	Right	Left	Thru	Right	Left	Thru	Right		
2022 May PM Peak Hour	8	3	36	109	3	18	23	542	2	8	610	43	1405	
Existing PM Pk Hr w/Seasonal Adj	10	5	40	120	5	20	25	605	2	10	685	50	1577	0.94
2043 Forecast (rnd&bal)	15	5	55	165	5	25	35	830	5	15	990	70	2215	
2028	10	5	40	125	5	20	25	625	5	10	720	50	1640	
2033	10	5	45	140	5	20	30	695	5	10	810	55	1830	
2038	15	5	50	150	5	25	30	760	5	15	900	65	2025	

I-82 EB ramps (southbound)/6th (US 730) (Intersection #6)

	Northbound			Southbound			Eastbound			Westbound			Total Volume	PHF
	Left	Thru	Right	Left	Thru	Right	Left	Thru	Right	Left	Thru	Right		
2022 May PM Peak Hour	0	0	0	275	2	304	0	590	97	60	357	0	1685	
Existing PM Pk Hr w/Seasonal Adj	0	0	0	310	2	340	0	660	110	65	400	0	1887	0.94
2043 Forecast (rnd&bal)	0	0	0	425	5	465	0	900	150	90	610	0	2645	
2028	0	0	0	320	5	350	0	680	110	70	430	0	1965	
2033	0	0	0	355	5	390	0	750	125	75	490	0	2190	
2038	0	0	0	390	5	425	0	825	135	85	550	0	2415	

I-82 WB ramps (northbound)/6th (US 730) (Intersection #7)

	Northbound			Southbound			Eastbound			Westbound			Total Volume	PHF
	Left	Thru	Right	Left	Thru	Right	Left	Thru	Right	Left	Thru	Right		
2022 May PM Peak Hour	25	1	111	0	0	0	272	593	0	0	392	419	1813	
2043 Forecast (rnd&bal)	40	2	170	0	0	0	415	910	0	0	660	645	2842	
2028	30	2	130	0	0	0	315	685	0	0	470	485	2117	
2033	35	2	140	0	0	0	345	760	0	0	530	535	2347	
2038	35	2	155	0	0	0	380	835	0	0	595	590	2592	

US 395/Devore Rd/6th St (US 730) (Intersection #8)

	Northbound			Southbound			Eastbound			Westbound			Total Volume	PHF
	Left	Thru	Right	Left	Thru	Right	Left	Thru	Right	Left	Thru	Right		
2022 May PM Peak Hour	418	9	222	5	12	37	6	247	397	220	339	4	1916	
Existing PM Pk Hr w/Seasonal Adj	470	10	250	5	15	40	5	275	445	245	380	5	2145	0.89
2043 Forecast (rnd&bal)	625	15	335	10	20	55	10	380	610	420	690	10	3180	
2028	475	10	255	5	15	40	5	285	460	275	440	5	2270	
2033	525	10	280	10	15	45	10	315	510	325	525	5	2575	
2038	575	15	310	10	20	50	10	350	560	370	605	10	2885	

Columbia/6th (US 730) (Intersection #9)

	Northbound			Southbound			Eastbound			Westbound			Total Volume	PHF
	Left	Thru	Right	Left	Thru	Right	Left	Thru	Right	Left	Thru	Right		
2022 May PM Peak Hour	0	0	0	1	0	114	0	444	0	0	482	0	1041	
Existing PM Pk Hr w/Seasonal Adj	0	0	0	1	0	130	0	495	0	0	540	0	1166	0.81
2043 Forecast (rnd&bal)	0	0	0	5	0	140	0	690	0	0	1010	0	1845	
2028	0	0	0	2	0	120	0	515	0	0	635	0	1272	
2033	0	0	0	3	0	135	0	595	0	0	785	0	1518	
2038	0	0	0	4	0	135	0	630	0	0	885	0	1654	

Willamette/6th (US 730) (Intersection #10)

	Northbound			Southbound			Eastbound			Westbound			Total	PHF
	Left	Thru	Right	Left	Thru	Right	Left	Thru	Right	Left	Thru	Right	Volume	
2022 May PM Peak Hour	0	0	0	29	0	146	303	142	0	0	338	70	1028	
Existing PM Pk Hr w/Seasonal Adj	0	0	0	30	0	165	340	160	0	0	380	80	1155	0.83
2043 Forecast (rnd&bal)				40		200	425	270			840	170	1945	
2028	0	0	0	30	0	165	340	180	0	0	480	100	1295	
2033	0	0	0	35	0	185	385	220	0	0	620	125	1570	
2038	0	0	0	35	0	185	395	240	0	0	720	145	1720	

Bud Draper/6th St (US 730) (Intersection #11)

	Northbound			Southbound			Eastbound			Westbound			Total	PHF
	Left	Thru	Right	Left	Thru	Right	Left	Thru	Right	Left	Thru	Right	Volume	
2022 May PM Peak Hour	0	0	0	11	0	35	7	160	0	0	368	3	584	
Existing PM Pk Hr w/Seasonal Adj	0	0	0	10	0	40	10	180	0	0	410	5	655	0.82
2043 Forecast (rnd&bal)				15		55	15	295			950	10	1340	
2028	0	0	0	10	0	40	10	200	0	0	535	5	800	
2033	0	0	0	15	0	50	15	240	0	0	695	10	1025	
2038	0	0	0	15	0	50	15	265	0	0	810	10	1165	

Beach Access/ (US 730) (Intersection #12)

	Northbound			Southbound			Eastbound			Westbound			Total	PHF
	Left	Thru	Right	Left	Thru	Right	Left	Thru	Right	Left	Thru	Right	Volume	
2022 May PM Peak Hour	0	0	0	33	0	179	16	157	0	0	115	3	503	
Existing PM Pk Hr w/Seasonal Adj	0	0	0	35	0	200	20	175	0	0	130	5	565	0.79
2043 Forecast (rnd&bal)				135	0	750	70	240			180	15	1390	
2028	0	0	0	60	0	340	30	180	0	0	135	5	750	
2033	0	0	0	85	0	490	45	210	0	0	155	10	995	
2038	0	0	0	110	0	615	55	220	0	0	165	10	1175	

Madison/Powerline (Intersection #13)

	Northbound			Southbound			Eastbound			Westbound			Total Volume	
	Left	Thru	Right	Left	Thru	Right	Left	Thru	Right	Left	Thru	Right	Hourly	
2022 May PM Peak Hour	8	145	0	0	160	11	12	0	4	0	0	0	340	
Existing PM Pk Hr w/Seasonal Adj	10	160	0	0	180	10	15	0	5	0	0	0	380	
2043 Forecast (rounded)	25	485			430	150	100		20				1210	
2028	15	255	0	0	250	50	40	0	10	0	0	0	620	
2033	20	330	0	0	310	85	60	0	15	0	0	0	820	
2038	20	410	0	0	370	115	80	0	15	0	0	0	1010	

MOVEMENT SUMMARY

Site: Int. 2 [Hwy 730 / P.Line Rd Single In 2028 (Site Folder: General)]

Output produced by SIDRA INTERSECTION Version: 9.1.2.202

2043 Build
 Site Category: (None)
 Roundabout

Vehicle Movement Performance															
Mov ID	Turn	Mov Class	Demand Flows		Arrival Flows		Deg. Satn	Aver. Delay	Level of Service	95% Back Of Queue		Prop. Que	Eff. Stop Rate	Aver. No. of Cycles	Aver. Speed
			[Total HV]	%	[Total HV]	%	v/c	sec		[Veh.]	[Dist]				mph
			veh/h		veh/h					veh	ft				
South: Power Line Road NB															
3	L2	All MCs	120	2.0	120	2.0	0.400	9.5	LOS A	2.9	73.8	0.77	0.57	0.77	29.0
18	R2	All MCs	196	2.0	196	2.0	0.400	9.5	LOS A	2.9	73.8	0.77	0.57	0.77	29.3
Approach			315	2.0	315	2.0	0.400	9.5	LOS A	2.9	73.8	0.77	0.57	0.77	29.2
East: Hwy 730 WB															
1	L2	All MCs	277	2.0	277	2.0	0.584	10.0	LOS B	6.2	156.4	0.60	0.31	0.60	28.8
6	T1	All MCs	386	2.0	386	2.0	0.584	10.0	LOS B	6.2	156.4	0.60	0.31	0.60	30.6
Approach			663	2.0	663	2.0	0.584	10.0	LOS B	6.2	156.4	0.60	0.31	0.60	29.8
West: Hwy 730 EB															
2	T1	All MCs	473	2.0	473	2.0	0.617	12.2	LOS B	7.1	179.3	0.77	0.58	0.91	30.6
12	R2	All MCs	130	2.0	130	2.0	0.617	12.2	LOS B	7.1	179.3	0.77	0.58	0.91	29.1
Approach			603	2.0	603	2.0	0.617	12.2	LOS B	7.1	179.3	0.77	0.58	0.91	30.3
All Vehicles			1582	2.0	1582	2.0	0.617	10.8	LOS B	7.1	179.3	0.70	0.46	0.75	29.9

Site Level of Service (LOS) Method: Delay & v/c (HCM 6). Site LOS Method is specified in the Parameter Settings dialog (Options tab).

Roundabout LOS Method: Same as Signalised Intersections.

Vehicle movement LOS values are based on average delay and v/c ratio (degree of saturation) per movement.

LOS F will result if v/c > 1 irrespective of movement delay value (does not apply for approaches and intersection).

Intersection and Approach LOS values are based on average delay for all movements (v/c not used as specified in HCM 6).

Roundabout Capacity Model: SIDRA HCM.

Delay Model: HCM Delay Formula (Stopline Delay: Geometric Delay is not included).

Queue Model: SIDRA queue estimation methods are used for Back of Queue and Queue at Start of Gap.

Gap-Acceptance Capacity Formula: SIDRA Standard (Akçelik M3D).

HV (%) values are calculated for All Movement Classes of All Heavy Vehicle Model Designation.

Arrival Flows used in performance calculations are adjusted to include any Initial Queued Demand and Upstream Capacity Constraint effects.

SIDRA INTERSECTION 9.1 | Copyright © 2000-2022 Akcelik and Associates Pty Ltd | sidrasolutions.com

Organisation: J.U.B ENGINEERS, INC. | Licence: PLUS / 1PC | Processed: Thursday, January 12, 2023 11:06:00 AM

Project: \\jub.com\central\Clients\OR\UmatillaCity\Projects\07-22-008_TransportationSystemPlan\Planning\Traffic\Sidra\Hwy 730_Powerline Rd.sip9

SITE LAYOUT

Site: Int. 2 [Hwy 730 / P.Line Rd Single In 2028 (Site Folder: General)]

2043 Build
Site Category: (None)
Roundabout

Layout pictures are schematic functional drawings reflecting input data. They are not design drawings.

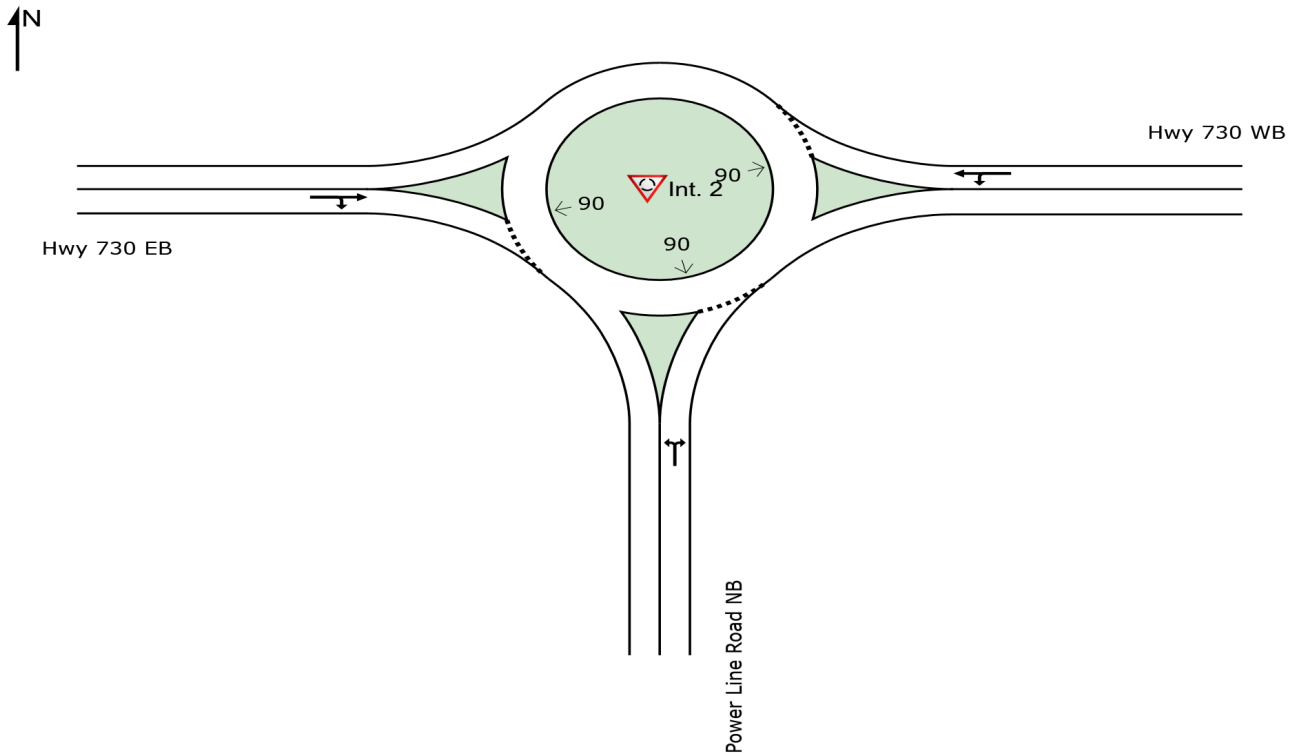

MOVEMENT SUMMARY

Site: Int. 2 [Hwy 730 / P.Line Rd Single In 2033 (Site Folder: General)]

Output produced by SIDRA INTERSECTION Version: 9.1.2.202

2043 Build
 Site Category: (None)
 Roundabout

Vehicle Movement Performance															
Mov ID	Turn	Mov Class	Demand Flows		Arrival Flows		Deg. Satn	Aver. Delay	Level of Service	95% Back Of Queue	Prop. Que	Eff. Stop Rate	Aver. No. of Cycles	Aver. Speed	
			[Total HV]	%	[Total HV]	%	v/c	sec		[Veh.]	[Dist]			mph	
			veh/h		veh/h					veh	ft				
South: Power Line Road NB															
3	L2	All MCs	163	2.0	163	2.0	0.548	12.8	LOS B	5.4	137.8	0.87	0.74	1.05	27.8
18	R2	All MCs	255	2.0	255	2.0	0.548	12.8	LOS B	5.4	137.8	0.87	0.74	1.05	28.1
Approach			418	2.0	418	2.0	0.548	12.8	LOS B	5.4	137.8	0.87	0.74	1.05	27.9
East: Hwy 730 WB															
1	L2	All MCs	353	2.0	353	2.0	0.697	13.5	LOS B	8.3	211.6	0.79	0.46	0.79	27.5
6	T1	All MCs	397	2.0	397	2.0	0.697	13.5	LOS B	8.3	211.6	0.79	0.46	0.79	29.2
Approach			750	2.0	750	2.0	0.697	13.5	LOS B	8.3	211.6	0.79	0.46	0.79	28.4
West: Hwy 730 EB															
2	T1	All MCs	478	2.0	478	2.0	0.726	17.1	LOS B	12.0	304.5	0.93	0.88	1.39	28.7
12	R2	All MCs	168	2.0	168	2.0	0.726	17.1	LOS B	12.0	304.5	0.93	0.88	1.39	27.3
Approach			647	2.0	647	2.0	0.726	17.1	LOS B	12.0	304.5	0.93	0.88	1.39	28.3
All Vehicles			1815	2.0	1815	2.0	0.726	14.6	LOS B	12.0	304.5	0.86	0.68	1.06	28.3

Site Level of Service (LOS) Method: Delay & v/c (HCM 6). Site LOS Method is specified in the Parameter Settings dialog (Options tab).

Roundabout LOS Method: Same as Signalised Intersections.

Vehicle movement LOS values are based on average delay and v/c ratio (degree of saturation) per movement.

LOS F will result if v/c > 1 irrespective of movement delay value (does not apply for approaches and intersection).

Intersection and Approach LOS values are based on average delay for all movements (v/c not used as specified in HCM 6).

Roundabout Capacity Model: SIDRA HCM.

Delay Model: HCM Delay Formula (Stopline Delay: Geometric Delay is not included).

Queue Model: SIDRA queue estimation methods are used for Back of Queue and Queue at Start of Gap.

Gap-Acceptance Capacity Formula: SIDRA Standard (Akçelik M3D).

HV (%) values are calculated for All Movement Classes of All Heavy Vehicle Model Designation.

Arrival Flows used in performance calculations are adjusted to include any Initial Queued Demand and Upstream Capacity Constraint effects.

SIDRA INTERSECTION 9.1 | Copyright © 2000-2022 Akcelik and Associates Pty Ltd | sidrasolutions.com

Organisation: J.U.B ENGINEERS, INC. | Licence: PLUS / 1PC | Processed: Thursday, January 12, 2023 11:11:00 AM

Project: \\jub.com\central\Clients\OR\UmatillaCity\Projects\07-22-008_TransportationSystemPlan\Planning\Traffic\Sidra\Hwy 730_Powerline Rd.sip9

SITE LAYOUT

Site: Int. 2 [Hwy 730 / P.Line Rd Single In 2033 (Site Folder: General)]

2043 Build
Site Category: (None)
Roundabout

Layout pictures are schematic functional drawings reflecting input data. They are not design drawings.

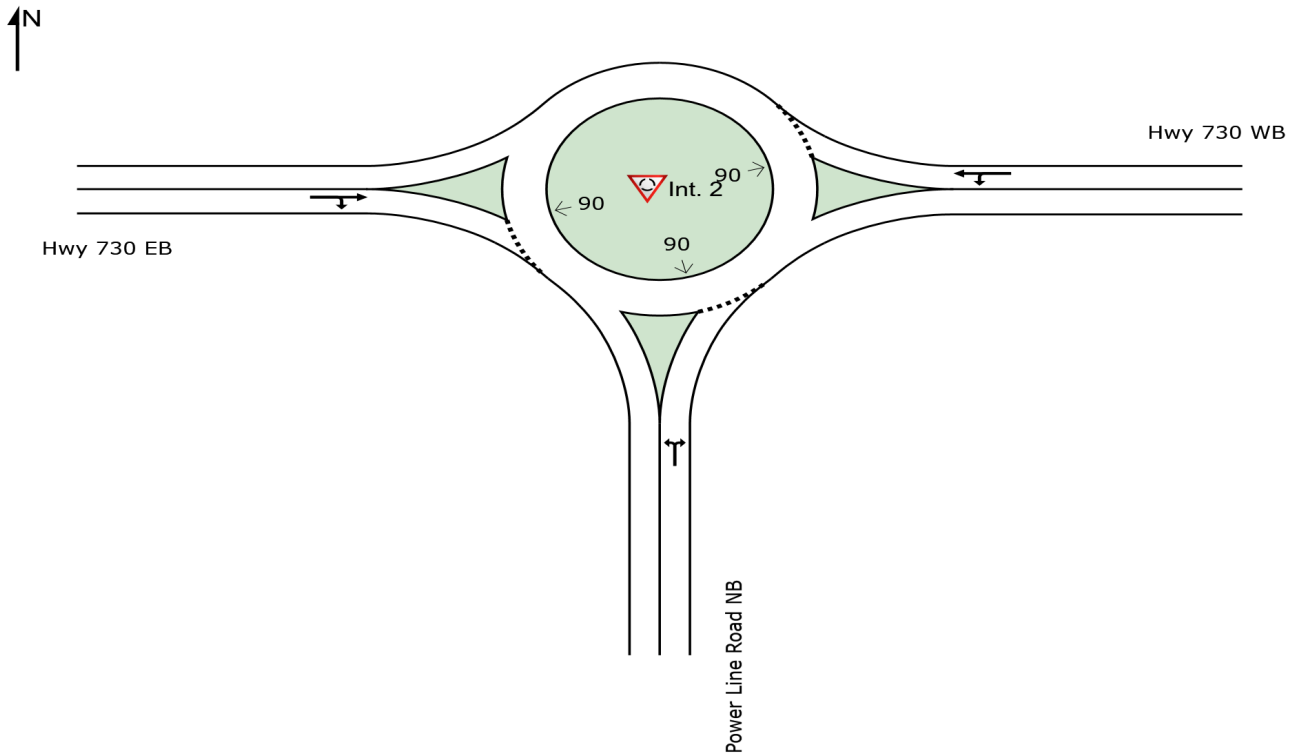

HCS7 Two-Way Stop-Control Report

General Information		Site Information	
Analyst	Montgomery	Intersection	Switzer/US 730
Agency/Co.	JUB Engineers	Jurisdiction	City of Umatilla
Date Performed	11/18/2022	East/West Street	6th Street (US 730)
Analysis Year	2028	North/South Street	Switzer Ave
Time Analyzed	PM Pk Hr season adj	Peak Hour Factor	0.92
Intersection Orientation	East-West	Analysis Time Period (hrs)	0.25
Project Description	Umatilla Transportation System Plan		

Lanes

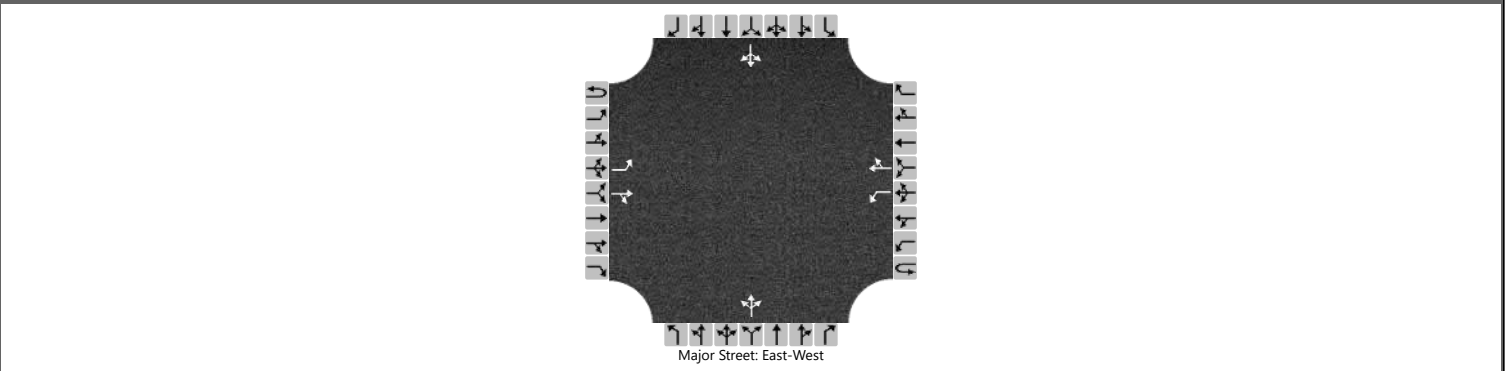

Vehicle Volumes and Adjustments

Approach	Eastbound				Westbound				Northbound				Southbound				
	U	L	T	R	U	L	T	R	U	L	T	R	U	L	T	R	
Movement	1U	1	2	3	4U	4	5	6		7	8	9		10	11	12	
Priority																	
Number of Lanes	0	1	1	0	0	1	1	0		0	1	0		0	1	0	
Configuration		L		TR		L		TR			LTR				LTR		
Volume (veh/h)		25	610	10		35	580	30		10	5	20		20	5	20	
Percent Heavy Vehicles (%)		3				3				3	3	3		3	3	3	
Proportion Time Blocked																	
Percent Grade (%)										0				0			
Right Turn Channelized																	
Median Type Storage	Undivided																

Critical and Follow-up Headways

Base Critical Headway (sec)		4.1				4.1				7.1	6.5	6.2		7.1	6.5	6.2
Critical Headway (sec)		4.13				4.13				7.13	6.53	6.23		7.13	6.53	6.23
Base Follow-Up Headway (sec)		2.2				2.2				3.5	4.0	3.3		3.5	4.0	3.3
Follow-Up Headway (sec)		2.23				2.23				3.53	4.03	3.33		3.53	4.03	3.33

Delay, Queue Length, and Level of Service

Flow Rate, v (veh/h)		27				38				38					49		
Capacity, c (veh/h)		921				912				181					150		
v/c Ratio		0.03				0.04				0.21					0.33		
95% Queue Length, Q ₉₅ (veh)		0.1				0.1				0.8					1.3		
Control Delay (s/veh)		9.0				9.1				30.1					40.1		
Level of Service (LOS)		A				A				D					E		
Approach Delay (s/veh)		0.3				0.5				30.1				40.1			
Approach LOS										D				E			

HCS7 Two-Way Stop-Control Report

General Information		Site Information	
Analyst	Montgomery	Intersection	Umatilla River Rd/US 730
Agency/Co.	JUB Engineers	Jurisdiction	City of Umatilla
Date Performed	11/18/2022	East/West Street	6th Street (US 730)
Analysis Year	2028	North/South Street	Umat. Riv Rd (Cnty 1275)
Time Analyzed	PM Pk Hr - mitigated	Peak Hour Factor	0.92
Intersection Orientation	East-West	Analysis Time Period (hrs)	0.25
Project Description	Umatilla Transportation System Plan		

Lanes

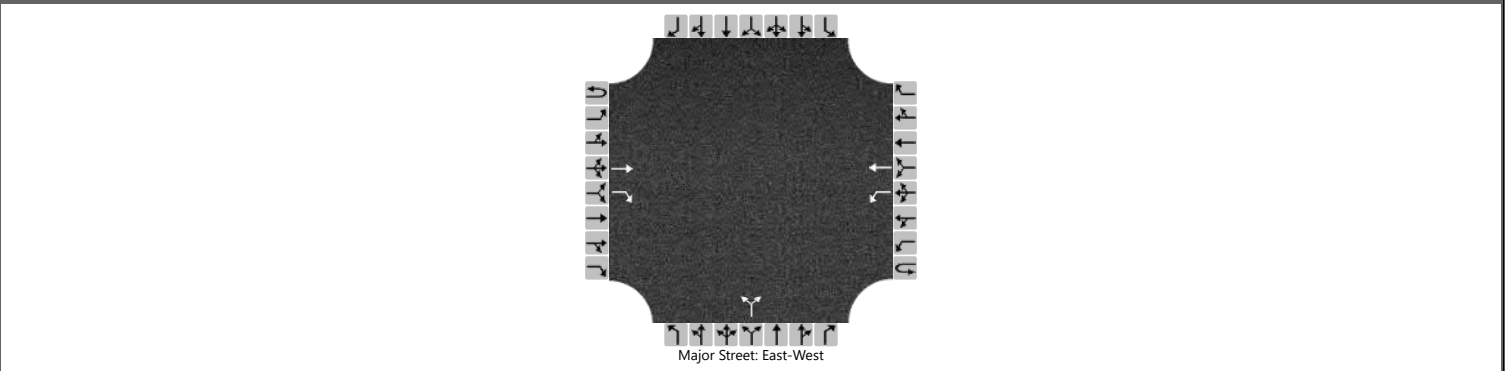

Vehicle Volumes and Adjustments

Approach	Eastbound				Westbound				Northbound				Southbound			
	U	L	T	R	U	L	T	R	U	L	T	R	U	L	T	R
Movement	1U	1	2	3	4U	4	5	6	7	8	9	10	11	12		
Priority																
Number of Lanes	0	0	1	1	0	1	1	0	0	1	0	0	0	0	0	
Configuration			T	R		L	T			LR						
Volume (veh/h)			535	170		115	540			140		100				
Percent Heavy Vehicles (%)						3				3		3				
Proportion Time Blocked																
Percent Grade (%)									0							
Right Turn Channelized	No															
Median Type Storage					Left Only								1			

Critical and Follow-up Headways

Base Critical Headway (sec)						4.1				7.1		6.2			
Critical Headway (sec)						4.13				6.43		6.23			
Base Follow-Up Headway (sec)						2.2				3.5		3.3			
Follow-Up Headway (sec)						2.23				3.53		3.33			

Delay, Queue Length, and Level of Service

Flow Rate, v (veh/h)						125					261					
Capacity, c (veh/h)						843					360					
v/c Ratio						0.15					0.73					
95% Queue Length, Q ₉₅ (veh)						0.5					5.5					
Control Delay (s/veh)						10.0					37.4					
Level of Service (LOS)						B					E					
Approach Delay (s/veh)					1.8				37.4							
Approach LOS									E							

HCS7 Two-Way Stop-Control Report

General Information				Site Information			
Analyst	Montgomery	Intersection	Umatilla River Rd/US 730				
Agency/Co.	JUB Engineers	Jurisdiction	City of Umatilla				
Date Performed	11/18/2022	East/West Street	6th Street (US 730)				
Analysis Year	2028	North/South Street	Umat. Riv Rd (Cnty 1275)				
Time Analyzed	PM Pk Hr - mitigated	Peak Hour Factor	0.92				
Intersection Orientation	East-West	Analysis Time Period (hrs)	0.25				
Project Description	Umatilla Transportation System Plan						

Lanes

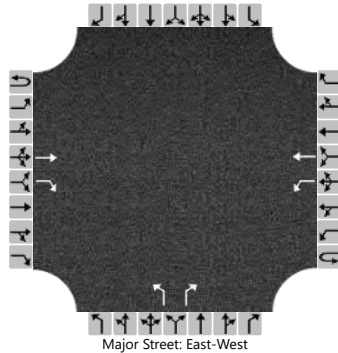

Vehicle Volumes and Adjustments

Approach	Eastbound				Westbound				Northbound				Southbound			
	U	L	T	R	U	L	T	R	U	L	T	R	U	L	T	R
Movement	1U	1	2	3	4U	4	5	6	7	8	9		10	11	12	
Priority																
Number of Lanes	0	0	1	1	0	1	1	0	1	0	1		0	0	0	
Configuration			T	R		L	T		L		R					
Volume (veh/h)			535	170		115	540		140		100					
Percent Heavy Vehicles (%)						3			3		3					
Proportion Time Blocked																
Percent Grade (%)									0							
Right Turn Channelized	No								No							
Median Type Storage					Left Only								1			

Critical and Follow-up Headways

Base Critical Headway (sec)						4.1				7.1		6.2				
Critical Headway (sec)						4.13				6.43		6.23				
Base Follow-Up Headway (sec)						2.2				3.5		3.3				
Follow-Up Headway (sec)						2.23				3.53		3.33				

Delay, Queue Length, and Level of Service

Flow Rate, v (veh/h)						125				152		109				
Capacity, c (veh/h)						843				254		511				
v/c Ratio						0.15				0.60		0.21				
95% Queue Length, Q ₉₅ (veh)						0.5				3.5		0.8				
Control Delay (s/veh)						10.0				38.2		13.9				
Level of Service (LOS)						B				E		B				
Approach Delay (s/veh)					1.8				28.1							
Approach LOS									D							

HCS7 Two-Way Stop-Control Report

General Information		Site Information	
Analyst	Montgomery	Intersection	Umatilla River Rd/US 730
Agency/Co.	JUB Engineers	Jurisdiction	City of Umatilla
Date Performed	11/18/2022	East/West Street	6th Street (US 730)
Analysis Year	2033	North/South Street	Umat. Riv Rd (Cnty 1275)
Time Analyzed	PM Pk Hr - mitigated	Peak Hour Factor	0.92
Intersection Orientation	East-West	Analysis Time Period (hrs)	0.25
Project Description	Umatilla Transportation System Plan		

Lanes

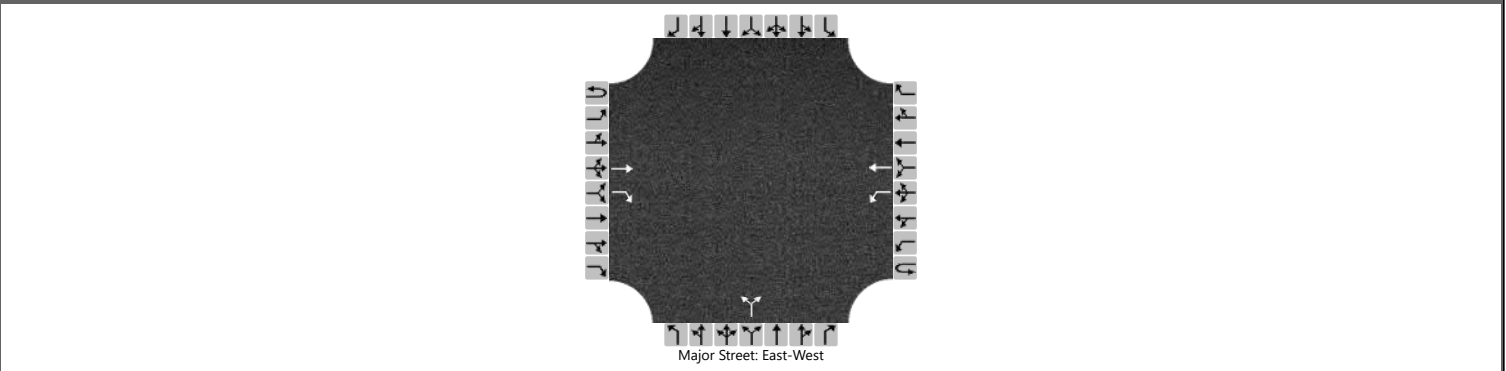

Vehicle Volumes and Adjustments

Approach	Eastbound				Westbound				Northbound				Southbound			
	U	L	T	R	U	L	T	R	U	L	T	R	U	L	T	R
Movement	1U	1	2	3	4U	4	5	6	7	8	9		10	11	12	
Priority																
Number of Lanes	0	0	1	1	0	1	1	0	0	1	0		0	0	0	
Configuration			T	R		L	T				LR					
Volume (veh/h)			580	185		125	610			155		110				
Percent Heavy Vehicles (%)						3				3		3				
Proportion Time Blocked																
Percent Grade (%)									0							
Right Turn Channelized	No															
Median Type Storage					Left Only								1			

Critical and Follow-up Headways

Base Critical Headway (sec)						4.1				7.1		6.2				
Critical Headway (sec)						4.13				6.43		6.23				
Base Follow-Up Headway (sec)						2.2				3.5		3.3				
Follow-Up Headway (sec)						2.23				3.53		3.33				

Delay, Queue Length, and Level of Service

Flow Rate, v (veh/h)						136					288					
Capacity, c (veh/h)						797					310					
v/c Ratio						0.17					0.93					
95% Queue Length, Q ₉₅ (veh)						0.6					9.1					
Control Delay (s/veh)						10.4					72.2					
Level of Service (LOS)						B					F					
Approach Delay (s/veh)					1.8				72.2							
Approach LOS									F							

HCS7 Two-Way Stop-Control Report

General Information				Site Information			
Analyst	Montgomery	Intersection	Umatilla River Rd/US 730				
Agency/Co.	JUB Engineers	Jurisdiction	City of Umatilla				
Date Performed	11/18/2022	East/West Street	6th Street (US 730)				
Analysis Year	2033	North/South Street	Umat. Riv Rd (Cnty 1275)				
Time Analyzed	PM Pk Hr - mitigated	Peak Hour Factor	0.92				
Intersection Orientation	East-West	Analysis Time Period (hrs)	0.25				
Project Description	Umatilla Transportation System Plan						

Lanes

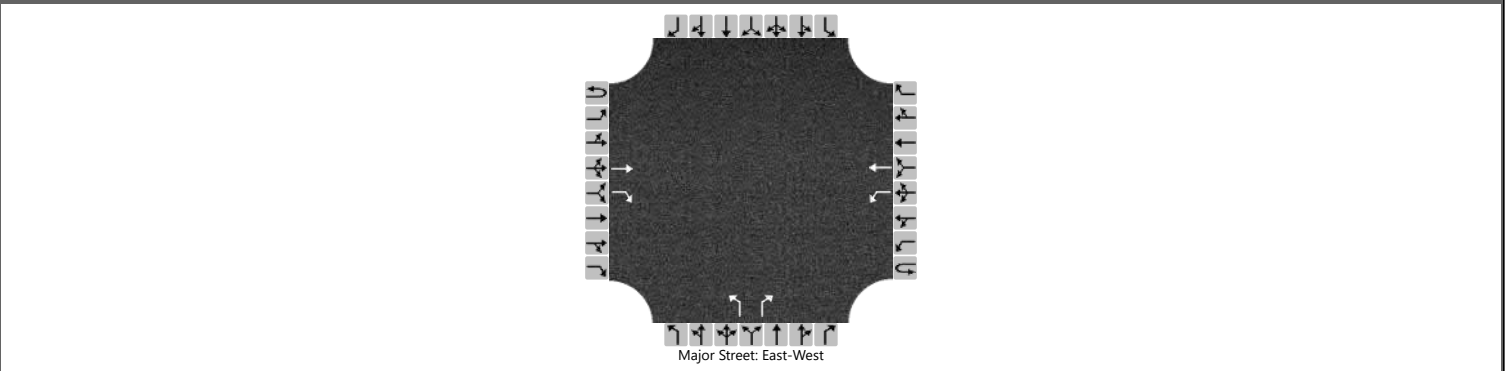

Vehicle Volumes and Adjustments

Approach	Eastbound				Westbound				Northbound				Southbound			
	U	L	T	R	U	L	T	R	U	L	T	R	U	L	T	R
Movement	1U	1	2	3	4U	4	5	6	7	8	9	10	11	12		
Priority																
Number of Lanes	0	0	1	1	0	1	1	0	1	0	1	0	0	0		
Configuration			T	R		L	T		L		R					
Volume (veh/h)			580	185		125	610		155		110					
Percent Heavy Vehicles (%)						3			3		3					
Proportion Time Blocked																
Percent Grade (%)									0							
Right Turn Channelized	No								No							
Median Type Storage					Left Only								1			

Critical and Follow-up Headways

Base Critical Headway (sec)						4.1				7.1		6.2				
Critical Headway (sec)						4.13				6.43		6.23				
Base Follow-Up Headway (sec)						2.2				3.5		3.3				
Follow-Up Headway (sec)						2.23				3.53		3.33				

Delay, Queue Length, and Level of Service

Flow Rate, v (veh/h)						136				168		120				
Capacity, c (veh/h)						797				223		480				
v/c Ratio						0.17				0.76		0.25				
95% Queue Length, Q ₉₅ (veh)						0.6				5.3		1.0				
Control Delay (s/veh)						10.4				58.6		15.0				
Level of Service (LOS)						B				F		B				
Approach Delay (s/veh)					1.8				40.5							
Approach LOS									E							

HCS7 Two-Way Stop-Control Report

General Information				Site Information			
Analyst	Montgomery			Intersection	Umatilla River Rd/US 730		
Agency/Co.	JUB Engineers			Jurisdiction	City of Umatilla		
Date Performed	11/18/2022			East/West Street	6th Street (US 730)		
Analysis Year	2038			North/South Street	Umat. Riv Rd (Cnty 1275)		
Time Analyzed	PM Pk Hr - mitigated			Peak Hour Factor	0.92		
Intersection Orientation	East-West			Analysis Time Period (hrs)	0.25		
Project Description	Umatilla Transportation System Plan						

Lanes

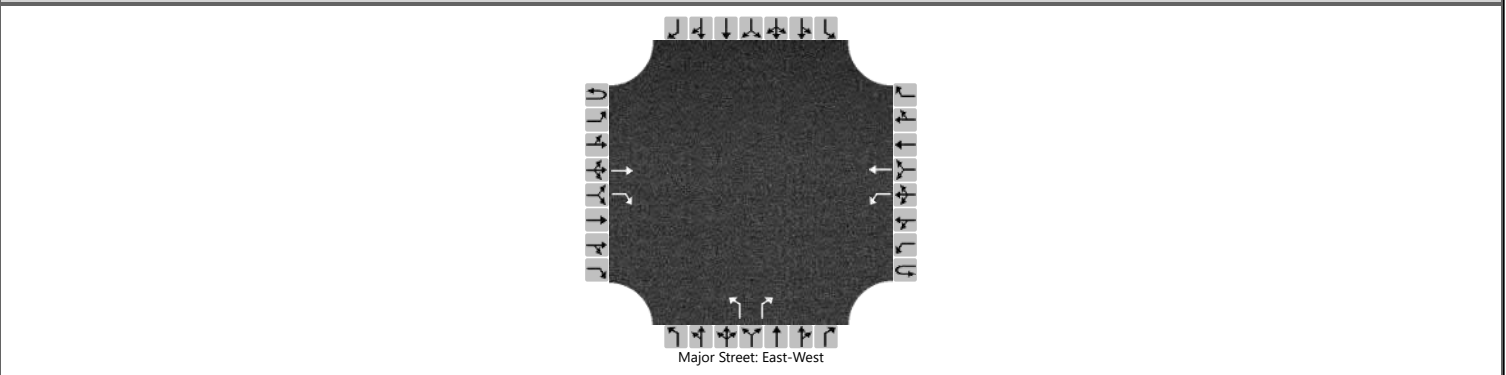

Vehicle Volumes and Adjustments

Approach	Eastbound				Westbound				Northbound				Southbound			
	U	L	T	R	U	L	T	R	U	L	T	R	U	L	T	R
Movement	1U	1	2	3	4U	4	5	6	7	8	9		10	11	12	
Priority																
Number of Lanes	0	0	1	1	0	1	1	0	1	0	1		0	0	0	
Configuration			T	R		L	T			L		R				
Volume (veh/h)			620	195		135	680			170		115				
Percent Heavy Vehicles (%)						3				3		3				
Proportion Time Blocked																
Percent Grade (%)									0							
Right Turn Channelized	No								No							
Median Type Storage					Left Only								1			

Critical and Follow-up Headways



















Base Critical Headway (sec)						4.1				7.1		6.2				
Critical Headway (sec)						4.13				6.43		6.23				
Base Follow-Up Headway (sec)						2.2				3.5		3.3				
Follow-Up Headway (sec)						2.23				3.53		3.33				

Delay, Queue Length, and Level of Service





Flow Rate, v (veh/h)						147				185		125				
Capacity, c (veh/h)						760				196		453				
v/c Ratio						0.19				0.95		0.28				
95% Queue Length, Q ₉₅ (veh)						0.7				7.7		1.1				
Control Delay (s/veh)						10.9				100.4		16.0				
Level of Service (LOS)						B				F		C				
Approach Delay (s/veh)					1.8				66.3							
Approach LOS									F							

Lanes, Volumes, Timings
5: 6th & Brownell

11/22/2022

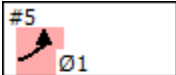
												
Lane Group	EBL	EBT	EBR	WBL	WBT	WBR	NBL	NBT	NBR	SBL	SBT	SBR
Lane Configurations												
Traffic Volume (vph)	30	695	5	10	810	55	10	5	45	140	5	20
Future Volume (vph)	30	695	5	10	810	55	10	5	45	140	5	20
Ideal Flow (vphpl)	1900	1900	1900	1900	1900	1900	1900	1900	1900	1900	1900	1900
Lane Width (ft)	12	12	12	12	12	12	12	12	12	12	12	12
Grade (%)		0%			0%			0%			0%	
Storage Length (ft)	165		0	0		0	0		0	0		0
Storage Lanes	1		0	1		0	0		0	0		1
Taper Length (ft)	135			25			25			25		
Lane Util. Factor	1.00	0.95	0.95	1.00	0.95	0.95	1.00	1.00	1.00	1.00	1.00	1.00
Ped Bike Factor												
Frt		0.999			0.990			0.899				0.850
Flt Protected	0.950			0.950				0.992			0.954	
Satd. Flow (prot)	1703	3402	0	1556	3081	0	0	1599	0	0	1119	997
Flt Permitted	0.950			0.950				0.956			0.723	
Satd. Flow (perm)	1703	3402	0	1556	3081	0	0	1541	0	0	848	997
Right Turn on Red			Yes			Yes			Yes			Yes
Satd. Flow (RTOR)		1			8			54				65
Link Speed (mph)		35			35			30				30
Link Distance (ft)		1078			236			248				460
Travel Time (s)		21.0			4.6			5.6				10.5
Confl. Peds. (#/hr)												
Confl. Bikes (#/hr)												
Peak Hour Factor	0.81	0.81	0.81	0.89	0.89	0.89	0.84	0.84	0.84	0.93	0.93	0.93
Growth Factor	100%	100%	100%	100%	100%	100%	100%	100%	100%	100%	100%	100%
Heavy Vehicles (%)	6%	6%	6%	16%	16%	16%	6%	6%	6%	62%	62%	62%
Bus Blockages (#/hr)	0	0	0	0	0	0	0	0	0	0	0	0
Parking (#/hr)												
Mid-Block Traffic (%)		0%			0%			0%			0%	
Adj. Flow (vph)	37	858	6	11	910	62	12	6	54	151	5	22
Shared Lane Traffic (%)												
Lane Group Flow (vph)	37	864	0	11	972	0	0	72	0	0	156	22
Enter Blocked Intersection	No	No	No	No	No	No	No	No	No	No	No	No
Lane Alignment	Left	Left	Right	Left	Left	Right	Left	Left	Right	Left	Left	Right
Median Width(ft)		12			12			0			0	
Link Offset(ft)		0			0			0			0	
Crosswalk Width(ft)		16			16			16			16	
Two way Left Turn Lane												
Headway Factor	1.00	1.00	1.00	1.00	1.00	1.00	1.00	1.00	1.00	1.00	1.00	1.00
Turning Speed (mph)	15		9	15		9	15		9	15		9
Number of Detectors	1	2		1	2		1	2		1	2	1
Detector Template	Left	Thru		Left	Thru		Left	Thru		Left	Thru	Right
Leading Detector (ft)	20	100		20	100		20	100		20	100	20
Trailing Detector (ft)	0	0		0	0		0	0		0	0	0
Turn Type	Prot	NA		Prot	NA		Perm	NA		Perm	NA	Perm
Protected Phases	1	6		5	2			4			8	
Permitted Phases							4			8		8
Detector Phase	1	6		5	2		4	4		8	8	8
Switch Phase												

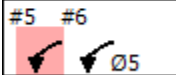
Splits and Phases: 5: 6th & Brownell

 <p>#5 Ø1</p>	 <p>#5 #6 Ø2</p>	 <p>#5 Ø4</p>
<p>13 s</p>	<p>42.5 s</p>	<p>44.5 s</p>
 <p>#5 #6 Ø5</p>	 <p>#5 #6 Ø6</p>	 <p>#5 #6 Ø8</p>
<p>14 s</p>	<p>41.5 s</p>	<p>44.5 s</p>

Lanes, Volumes, Timings

6: I-82 SB Entrance Ramp/I-82 SB Exit Ramp & 6th

11/22/2022



Lane Group	EBL	EBT	EBR	WBL	WBT	WBR	NBL	NBT	NBR	SBL	SBT	SBR
Lane Configurations		↑↑		↖	↑↑						↖	↖
Traffic Volume (vph)	0	750	125	75	490	0	0	0	0	355	5	390
Future Volume (vph)	0	750	125	75	490	0	0	0	0	355	5	390
Ideal Flow (vphpl)	1900	1900	1900	1900	1900	1900	1900	1900	1900	1900	1900	1900
Lane Width (ft)	12	12	12	12	12	12	12	12	12	12	12	12
Grade (%)		0%			0%			0%			0%	
Storage Length (ft)	0		0	110		0	0		0	0		0
Storage Lanes	0		0	1		0	0		0	0		1
Taper Length (ft)	25			45			25			25		
Lane Util. Factor	1.00	0.95	0.95	1.00	0.95	1.00	1.00	1.00	1.00	1.00	1.00	1.00
Ped Bike Factor												
Frt		0.979										0.850
Flt Protected				0.950							0.953	
Satd. Flow (prot)	0	3047	0	1687	3374	0	0	0	0	0	1548	1380
Flt Permitted				0.950							0.953	
Satd. Flow (perm)	0	3047	0	1687	3374	0	0	0	0	0	1548	1380
Right Turn on Red			Yes			Yes			Yes			Yes
Satd. Flow (RTOR)		21										342
Link Speed (mph)		35			35			45				45
Link Distance (ft)		236			481			189				496
Travel Time (s)		4.6			9.4			2.9				7.5
Confl. Peds. (#/hr)												
Confl. Bikes (#/hr)												
Peak Hour Factor	0.85	0.85	0.85	0.91	0.91	0.91	0.92	0.92	0.92	0.93	0.93	0.93
Growth Factor	100%	100%	100%	100%	100%	100%	100%	100%	100%	100%	100%	100%
Heavy Vehicles (%)	16%	16%	16%	7%	7%	7%	2%	2%	2%	17%	17%	17%
Bus Blockages (#/hr)	0	0	0	0	0	0	0	0	0	0	0	0
Parking (#/hr)												
Mid-Block Traffic (%)		0%			0%			0%				0%
Adj. Flow (vph)	0	882	147	82	538	0	0	0	0	382	5	419
Shared Lane Traffic (%)												
Lane Group Flow (vph)	0	1029	0	82	538	0	0	0	0	0	387	419
Enter Blocked Intersection	No	No	No	No	No	No	No	No	No	No	No	No
Lane Alignment	Left	Right	Right	Left	Right	R NA	Left	Left	Right	Left	Left	Right
Median Width(ft)		12			12			0				0
Link Offset(ft)		0			0			0				0
Crosswalk Width(ft)		16			16			16				16
Two way Left Turn Lane												
Headway Factor	1.00	1.00	1.00	1.00	1.00	1.00	1.00	1.00	1.00	1.00	1.00	1.00
Turning Speed (mph)	15		9	15		9	15		9	15		9
Number of Detectors		2		1	2					1	2	1
Detector Template		Thru		Left	Thru					Left	Thru	Right
Leading Detector (ft)		100		20	100					20	100	20
Trailing Detector (ft)		0		0	0					0	0	0
Turn Type		NA		Prot	NA					Perm	NA	Perm
Protected Phases		6		5	2						8	
Permitted Phases										8		8
Detector Phase		6		5	2					8	8	8
Switch Phase												

Lane Group	Ø1	Ø4
Lane Configurations		
Traffic Volume (vph)		
Future Volume (vph)		
Ideal Flow (vphpl)		
Lane Width (ft)		
Grade (%)		
Storage Length (ft)		
Storage Lanes		
Taper Length (ft)		
Lane Util. Factor		
Ped Bike Factor		
Frt		
Flt Protected		
Satd. Flow (prot)		
Flt Permitted		
Satd. Flow (perm)		
Right Turn on Red		
Satd. Flow (RTOR)		
Link Speed (mph)		
Link Distance (ft)		
Travel Time (s)		
Confl. Peds. (#/hr)		
Confl. Bikes (#/hr)		
Peak Hour Factor		
Growth Factor		
Heavy Vehicles (%)		
Bus Blockages (#/hr)		
Parking (#/hr)		
Mid-Block Traffic (%)		
Adj. Flow (vph)		
Shared Lane Traffic (%)		
Lane Group Flow (vph)		
Enter Blocked Intersection		
Lane Alignment		
Median Width(ft)		
Link Offset(ft)		
Crosswalk Width(ft)		
Two way Left Turn Lane		
Headway Factor		
Turning Speed (mph)		
Number of Detectors		
Detector Template		
Leading Detector (ft)		
Trailing Detector (ft)		
Turn Type		
Protected Phases	1	4
Permitted Phases		
Detector Phase		
Switch Phase		

Lanes, Volumes, Timings
6: I-82 SB Entrance Ramp/I-82 SB Exit Ramp & 6th

11/22/2022



Lane Group	EBL	EBT	EBR	WBL	WBT	WBR	NBL	NBT	NBR	SBL	SBT	SBR
Minimum Initial (s)		10.0		7.0	10.0					7.0	7.0	7.0
Minimum Split (s)		40.5		13.0	36.5					44.5	44.5	44.5
Total Split (s)		41.5		14.0	42.5					44.5	44.5	44.5
Total Split (%)		41.5%		14.0%	42.5%					44.5%	44.5%	44.5%
Maximum Green (s)		37.0		9.5	38.0					40.0	40.0	40.0
Yellow Time (s)		4.0		4.0	4.0					4.0	4.0	4.0
All-Red Time (s)		0.5		0.5	0.5					0.5	0.5	0.5
Lost Time Adjust (s)		0.0		0.0	0.0						0.0	0.0
Total Lost Time (s)		4.5		4.5	4.5						4.5	4.5
Lead/Lag		Lag		Lead	Lag							
Lead-Lag Optimize?		Yes		Yes								
Vehicle Extension (s)		5.6		3.5	4.6					5.0	5.0	5.0
Minimum Gap (s)		3.6		2.0	2.6					5.0	5.0	5.0
Time Before Reduce (s)		10.0		10.0	10.0					5.0	5.0	5.0
Time To Reduce (s)		10.0		10.0	10.0					5.0	5.0	5.0
Recall Mode		Min		None	Min					None	None	None
Walk Time (s)		7.0			7.0					7.0	7.0	7.0
Flash Dont Walk (s)		29.0			22.0					25.0	25.0	25.0
Pedestrian Calls (#/hr)		0			0					0	0	0
Act Effct Green (s)		37.2		8.9	40.4						33.0	33.0
Actuated g/C Ratio		0.41		0.10	0.45						0.37	0.37
v/c Ratio		0.81		0.49	0.35						0.68	0.58
Control Delay		16.7		52.9	19.7						31.2	8.3
Queue Delay		0.0		0.0	0.1						0.0	0.1
Total Delay		16.7		52.9	19.7						31.2	8.3
LOS		B		D	B						C	A
Approach Delay		16.7			24.1						19.3	
Approach LOS		B			C						B	
Queue Length 50th (ft)		75		50	125						194	31
Queue Length 95th (ft)		#90		99	177						297	113
Internal Link Dist (ft)		156			401			109			416	
Turn Bay Length (ft)				110								
Base Capacity (vph)		1313		185	1575						714	821
Starvation Cap Reductn		2		0	0						0	0
Spillback Cap Reductn		0		0	171						0	23
Storage Cap Reductn		0		0	0						0	0
Reduced v/c Ratio		0.78		0.44	0.38						0.54	0.53

Intersection Summary

Area Type:	Other
Cycle Length:	100
Actuated Cycle Length:	89.7
Natural Cycle:	100
Control Type:	Actuated-Uncoordinated
Maximum v/c Ratio:	0.81
Intersection Signal Delay:	19.4
Intersection LOS:	B
Intersection Capacity Utilization:	61.7%
ICU Level of Service:	B
Analysis Period (min):	15
# 95th percentile volume exceeds capacity, queue may be longer.	

Lanes, Volumes, Timings
 6: I-82 SB Entrance Ramp/I-82 SB Exit Ramp & 6th

11/22/2022

Lane Group	Ø1	Ø4
Minimum Initial (s)	7.0	7.0
Minimum Split (s)	13.0	36.5
Total Split (s)	13.0	44.5
Total Split (%)	13%	45%
Maximum Green (s)	8.5	40.0
Yellow Time (s)	4.0	4.0
All-Red Time (s)	0.5	0.5
Lost Time Adjust (s)		
Total Lost Time (s)		
Lead/Lag	Lead	
Lead-Lag Optimize?		
Vehicle Extension (s)	3.5	3.5
Minimum Gap (s)	2.0	2.0
Time Before Reduce (s)	10.0	15.0
Time To Reduce (s)	10.0	15.0
Recall Mode	None	None
Walk Time (s)		7.0
Flash Dont Walk (s)		23.0
Pedestrian Calls (#/hr)		0
Act Effct Green (s)		
Actuated g/C Ratio		
v/c Ratio		
Control Delay		
Queue Delay		
Total Delay		
LOS		
Approach Delay		
Approach LOS		
Queue Length 50th (ft)		
Queue Length 95th (ft)		
Internal Link Dist (ft)		
Turn Bay Length (ft)		
Base Capacity (vph)		
Starvation Cap Reductn		
Spillback Cap Reductn		
Storage Cap Reductn		
Reduced v/c Ratio		
Intersection Summary		

Queue shown is maximum after two cycles.



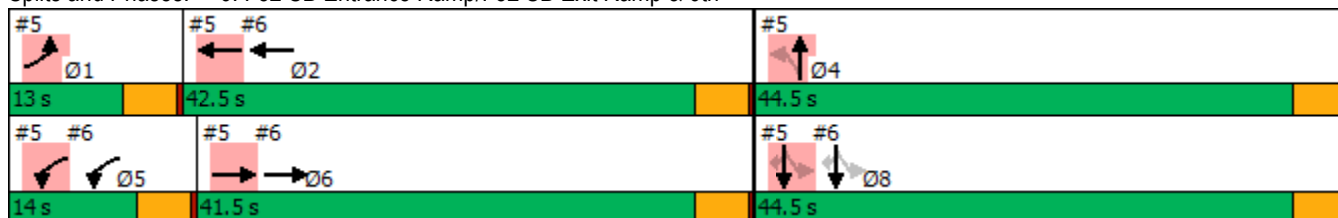













Splits and Phases: 6: I-82 SB Entrance Ramp/I-82 SB Exit Ramp & 6th



Lanes, Volumes, Timings

7: I-82 NB Exit Ramp/I-82 NB Entrance Ramp & 6th

11/22/2022





















												
Lane Group	EBL	EBT	EBR	WBL	WBT	WBR	NBL	NBT	NBR	SBL	SBT	SBR
Lane Configurations												
Traffic Volume (vph)	345	760	0	0	530	535	35	2	140	0	0	0
Future Volume (vph)	345	760	0	0	530	535	35	2	140	0	0	0
Ideal Flow (vphpl)	1900	1900	1900	1900	1900	1900	1900	1900	1900	1900	1900	1900
Lane Width (ft)	12	12	12	12	12	12	12	12	12	12	12	12
Grade (%)		0%			0%			0%			0%	
Storage Length (ft)	110		0	0		0	0		215	0		0
Storage Lanes	1		0	0		0	0		1	0		0
Taper Length (ft)	70			25			25			25		
Lane Util. Factor	1.00	0.95	1.00	1.00	0.95	0.95	1.00	1.00	1.00	1.00	1.00	1.00
Ped Bike Factor												
Flt					0.925				0.850			
Flt Protected	0.950							0.954				
Satd. Flow (prot)	1719	3438	0	0	3180	0	0	1474	1313	0	0	0
Flt Permitted	0.950							0.954				
Satd. Flow (perm)	1719	3438	0	0	3180	0	0	1474	1313	0	0	0
Link Speed (mph)		35			45			45			45	
Link Distance (ft)		481			3338			681			572	
Travel Time (s)		9.4			50.6			10.3			8.7	
Confl. Peds. (#/hr)												
Confl. Bikes (#/hr)												
Peak Hour Factor	0.80	0.80	0.80	0.85	0.85	0.85	0.82	0.82	0.82	0.92	0.92	0.92
Growth Factor	100%	100%	100%	100%	100%	100%	100%	100%	100%	100%	100%	100%
Heavy Vehicles (%)	5%	5%	5%	5%	5%	5%	23%	23%	23%	2%	2%	2%
Bus Blockages (#/hr)	0	0	0	0	0	0	0	0	0	0	0	0
Parking (#/hr)												
Mid-Block Traffic (%)		0%			0%			0%			0%	
Adj. Flow (vph)	431	950	0	0	624	629	43	2	171	0	0	0
Shared Lane Traffic (%)												
Lane Group Flow (vph)	431	950	0	0	1253	0	0	45	171	0	0	0
Enter Blocked Intersection	No	No	No	No	No	No	No	No	No	No	No	No
Lane Alignment	Left	Left	Right	Left	Left	Right	Left	Left	Right	Left	Left	Right
Median Width(ft)		12			12			0			0	
Link Offset(ft)		0			0			0			0	
Crosswalk Width(ft)		16			16			16			16	
Two way Left Turn Lane												
Headway Factor	1.00	1.00	1.00	1.00	1.00	1.00	1.00	1.00	1.00	1.00	1.00	1.00
Turning Speed (mph)	15		9	15		9	15		9	15		9
Sign Control		Free			Free			Stop			Stop	

Intersection Summary

Area Type:	Other
Control Type:	Unsignalized
Intersection Capacity Utilization	64.3%
ICU Level of Service	C
Analysis Period (min)	15

Lanes, Volumes, Timings
8: Devore & 6th

11/22/2022

												
Lane Group	EBL	EBT	EBR	WBL	WBT	WBR	NBL	NBT	NBR	SBL	SBT	SBR
Lane Configurations												
Traffic Volume (vph)	10	315	0	325	525	5	525	10	280	10	15	45
Future Volume (vph)	10	315	0	325	525	5	525	10	280	10	15	45
Ideal Flow (vphpl)	1900	1900	1900	1900	1900	1900	1900	1900	1900	1900	1900	1900
Lane Width (ft)	12	12	12	12	12	12	12	12	12	12	12	12
Grade (%)		0%			0%			0%			0%	
Storage Length (ft)	125		0	145		0	0		0	0		0
Storage Lanes	1		0	1		0	0		1	0		0
Taper Length (ft)	60			88			25			25		
Lane Util. Factor	1.00	0.95	1.00	1.00	0.95	0.95	1.00	1.00	1.00	1.00	1.00	1.00
Ped Bike Factor												
Flt					0.999				0.850		0.914	
Flt Protected	0.950			0.950				0.953			0.993	
Satd. Flow (prot)	1770	3539	0	1770	3536	0	0	1775	1583	0	1691	0
Flt Permitted	0.950			0.950				0.596			0.829	
Satd. Flow (perm)	1770	3539	0	1770	3536	0	0	1110	1583	0	1411	0
Right Turn on Red			Yes			Yes			Yes			Yes
Satd. Flow (RTOR)					1				258			81
Link Speed (mph)		45			45			45			45	
Link Distance (ft)		343			889			455			382	
Travel Time (s)		5.2			13.5			6.9			5.8	
Confl. Peds. (#/hr)												
Confl. Bikes (#/hr)												
Peak Hour Factor	0.82	0.82	0.82	0.72	0.72	0.72	0.90	0.90	0.90	0.42	0.42	0.42
Growth Factor	100%	100%	100%	100%	100%	100%	100%	100%	100%	100%	100%	100%
Heavy Vehicles (%)	2%	2%	2%	2%	2%	2%	2%	2%	2%	2%	2%	2%
Bus Blockages (#/hr)	0	0	0	0	0	0	0	0	0	0	0	0
Parking (#/hr)												
Mid-Block Traffic (%)		0%			0%			0%			0%	
Adj. Flow (vph)	12	384	0	451	729	7	583	11	311	24	36	107
Shared Lane Traffic (%)												
Lane Group Flow (vph)	12	384	0	451	736	0	0	594	311	0	167	0
Enter Blocked Intersection	No	No	No	No	No	No	No	No	No	No	No	No
Lane Alignment	Left	Left	Right	Left	Left	Right	Left	Left	Right	Left	Left	Right
Median Width(ft)		12			12			0			0	
Link Offset(ft)		0			0			0			0	
Crosswalk Width(ft)		16			16			16			16	
Two way Left Turn Lane												
Headway Factor	1.00	1.00	1.00	1.00	1.00	1.00	1.00	1.00	1.00	1.00	1.00	1.00
Turning Speed (mph)	15		9	15		9	15		9	15		9
Number of Detectors	1	2		1	2		1	2	1	1	2	
Detector Template	Left	Thru		Left	Thru		Left	Thru	Right	Left	Thru	
Leading Detector (ft)	20	100		20	100		20	100	20	20	100	
Trailing Detector (ft)	0	0		0	0		0	0	0	0	0	
Turn Type	Prot	NA		Prot	NA		Perm	NA	Perm	Perm	NA	
Protected Phases	5	2		1	6			8			4	
Permitted Phases							8		8	4		
Detector Phase	5	2		1	6		8	8	8	4	4	
Switch Phase												

Lanes, Volumes, Timings

8: Devore & 6th

11/22/2022



Lane Group	EBL	EBT	EBR	WBL	WBT	WBR	NBL	NBT	NBR	SBL	SBT	SBR
Minimum Initial (s)	8.0	10.0		8.0	10.0		8.0	8.0	8.0	7.0	7.0	
Minimum Split (s)	13.0	36.5		13.0	31.5		46.5	46.5	46.5	36.5	36.5	
Total Split (s)	13.0	39.0		36.0	62.0		75.0	75.0	75.0	75.0	75.0	
Total Split (%)	8.7%	26.0%		24.0%	41.3%		50.0%	50.0%	50.0%	50.0%	50.0%	
Maximum Green (s)	8.5	33.5		31.5	56.5		69.5	69.5	69.5	70.5	70.5	
Yellow Time (s)	4.0	5.0		4.0	5.0		5.0	5.0	5.0	4.0	4.0	
All-Red Time (s)	0.5	0.5		0.5	0.5		0.5	0.5	0.5	0.5	0.5	
Lost Time Adjust (s)	0.0	0.0		0.0	0.0			0.0	0.0			0.0
Total Lost Time (s)	4.5	5.5		4.5	5.5			5.5	5.5			4.5
Lead/Lag	Lead	Lag		Lead	Lag							
Lead-Lag Optimize?	Yes	Yes		Yes	Yes							
Vehicle Extension (s)	2.5	7.0		3.5	5.4		3.5	3.5	3.5	2.5	2.5	
Minimum Gap (s)	1.0	3.4		2.5	3.4		1.5	1.5	1.5	1.0	1.0	
Time Before Reduce (s)	5.0	15.0		5.0	15.0		10.0	10.0	10.0	5.0	5.0	
Time To Reduce (s)	5.0	15.0		5.0	15.0		10.0	10.0	10.0	5.0	5.0	
Recall Mode	None	Min		None	Min		None	None	None	None	None	
Walk Time (s)		7.0			7.0		7.0	7.0	7.0	7.0	7.0	
Flash Dont Walk (s)		24.0			19.0		34.0	34.0	34.0	25.0	25.0	
Pedestrian Calls (#/hr)		0			0		0	0	0	0	0	
Act Effct Green (s)	8.0	24.3		31.5	55.5			69.5	69.5			70.5
Actuated g/C Ratio	0.06	0.17		0.22	0.39			0.49	0.49			0.50
v/c Ratio	0.12	0.63		1.14	0.53			1.09	0.34			0.22
Control Delay	67.6	58.9		137.9	35.1			98.4	5.5			11.2
Queue Delay	0.0	0.0		0.0	0.0			0.0	0.0			0.0
Total Delay	67.6	58.9		137.9	35.1			98.4	5.5			11.2
LOS	E	E		F	D			F	A			B
Approach Delay		59.1			74.2			66.5				11.2
Approach LOS		E			E			E				B
Queue Length 50th (ft)	11	174		~478	252			~605	25			41
Queue Length 95th (ft)	31	205		#514	271			#895	87			17
Internal Link Dist (ft)		263			809			375				302
Turn Bay Length (ft)	125			145								
Base Capacity (vph)	106	841		395	1448			547	911			746
Starvation Cap Reductn	0	0		0	0			0	0			0
Spillback Cap Reductn	0	0		0	0			0	0			0
Storage Cap Reductn	0	0		0	0			0	0			0
Reduced v/c Ratio	0.11	0.46		1.14	0.51			1.09	0.34			0.22

Intersection Summary

Area Type:	Other
Cycle Length:	150
Actuated Cycle Length:	140.9
Natural Cycle:	150
Control Type:	Actuated-Uncoordinated
Maximum v/c Ratio:	1.14
Intersection Signal Delay:	65.4
Intersection LOS:	E
Intersection Capacity Utilization:	75.9%
ICU Level of Service:	D
Analysis Period (min):	15

~ Volume exceeds capacity, queue is theoretically infinite.

Lanes, Volumes, Timings

8: Devore & 6th

11/22/2022

Queue shown is maximum after two cycles.

95th percentile volume exceeds capacity, queue may be longer.





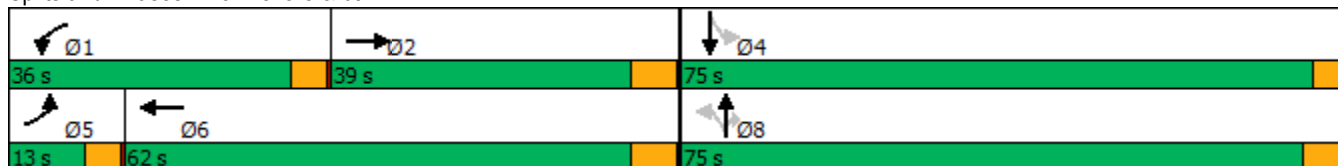













Queue shown is maximum after two cycles.

Splits and Phases: 8: Devore & 6th



Lanes, Volumes, Timings
5: 6th & Brownell

11/22/2022

												
Lane Group	EBL	EBT	EBR	WBL	WBT	WBR	NBL	NBT	NBR	SBL	SBT	SBR
Lane Configurations												
Traffic Volume (vph)	30	760	5	15	900	65	15	5	50	150	5	25
Future Volume (vph)	30	760	5	15	900	65	15	5	50	150	5	25
Ideal Flow (vphpl)	1900	1900	1900	1900	1900	1900	1900	1900	1900	1900	1900	1900
Storage Length (ft)	165		0	0		0	0		0	0		0
Storage Lanes	1		0	1		0	0		0	0		1
Taper Length (ft)	135			25			25			25		
Lane Util. Factor	1.00	0.95	0.95	1.00	0.95	0.95	1.00	1.00	1.00	1.00	1.00	1.00
Frt		0.999			0.990			0.904				0.850
Flt Protected	0.950			0.950				0.989			0.954	
Satd. Flow (prot)	1703	3402	0	1556	3081	0	0	1603	0	0	1119	997
Flt Permitted	0.950			0.950				0.935			0.706	
Satd. Flow (perm)	1703	3402	0	1556	3081	0	0	1515	0	0	828	997
Right Turn on Red			Yes			Yes			Yes			Yes
Satd. Flow (RTOR)		1			8			60				65
Link Speed (mph)		35			35			30				30
Link Distance (ft)		1078			236			248				460
Travel Time (s)		21.0			4.6			5.6				10.5
Peak Hour Factor	0.81	0.81	0.81	0.89	0.89	0.89	0.84	0.84	0.84	0.93	0.93	0.93
Heavy Vehicles (%)	6%	6%	6%	16%	16%	16%	6%	6%	6%	62%	62%	62%
Adj. Flow (vph)	37	938	6	17	1011	73	18	6	60	161	5	27
Shared Lane Traffic (%)												
Lane Group Flow (vph)	37	944	0	17	1084	0	0	84	0	0	166	27
Enter Blocked Intersection	No	No	No	No	No	No	No	No	No	No	No	No
Lane Alignment	Left	Left	Right	Left	Left	Right	Left	Left	Right	Left	Left	Right
Median Width(ft)		12			12			0				0
Link Offset(ft)		0			0			0				0
Crosswalk Width(ft)		16			16			16				16
Two way Left Turn Lane												
Headway Factor	1.00	1.00	1.00	1.00	1.00	1.00	1.00	1.00	1.00	1.00	1.00	1.00
Turning Speed (mph)	15		9	15		9	15		9	15		9
Number of Detectors	1	2		1	2		1	2		1	2	1
Detector Template	Left	Thru		Left	Thru		Left	Thru		Left	Thru	Right
Leading Detector (ft)	20	100		20	100		20	100		20	100	20
Trailing Detector (ft)	0	0		0	0		0	0		0	0	0
Detector 1 Position(ft)	0	0		0	0		0	0		0	0	0
Detector 1 Size(ft)	20	6		20	6		20	6		20	6	20
Detector 1 Type	Cl+Ex	Cl+Ex		Cl+Ex	Cl+Ex		Cl+Ex	Cl+Ex		Cl+Ex	Cl+Ex	Cl+Ex
Detector 1 Channel												
Detector 1 Extend (s)	0.0	0.0		0.0	0.0		0.0	0.0		0.0	0.0	0.0
Detector 1 Queue (s)	0.0	0.0		0.0	0.0		0.0	0.0		0.0	0.0	0.0
Detector 1 Delay (s)	0.0	0.0		0.0	0.0		0.0	0.0		0.0	0.0	0.0
Detector 2 Position(ft)		94			94			94				94
Detector 2 Size(ft)		6			6			6				6
Detector 2 Type		Cl+Ex			Cl+Ex			Cl+Ex				Cl+Ex
Detector 2 Channel												
Detector 2 Extend (s)		0.0			0.0			0.0				0.0
Turn Type	Prot	NA		Prot	NA		Perm	NA		Perm	NA	Perm
Protected Phases	1	6		5	2			4				8

Lanes, Volumes, Timings
5: 6th & Brownell

11/22/2022



Lane Group	EBL	EBT	EBR	WBL	WBT	WBR	NBL	NBT	NBR	SBL	SBT	SBR
Permitted Phases							4			8		8
Detector Phase	1	6		5	2		4	4		8	8	8
Switch Phase												
Minimum Initial (s)	7.0	10.0		7.0	10.0		7.0	7.0		7.0	7.0	7.0
Minimum Split (s)	13.0	40.5		13.0	36.5		36.5	36.5		44.5	44.5	44.5
Total Split (s)	13.0	39.4		16.0	42.4		44.6	44.6		44.6	44.6	44.6
Total Split (%)	13.0%	39.4%		16.0%	42.4%		44.6%	44.6%		44.6%	44.6%	44.6%
Maximum Green (s)	8.5	34.9		11.5	37.9		40.1	40.1		40.1	40.1	40.1
Yellow Time (s)	4.0	4.0		4.0	4.0		4.0	4.0		4.0	4.0	4.0
All-Red Time (s)	0.5	0.5		0.5	0.5		0.5	0.5		0.5	0.5	0.5
Lost Time Adjust (s)	0.0	0.0		0.0	0.0			0.0			0.0	0.0
Total Lost Time (s)	4.5	4.5		4.5	4.5			4.5			4.5	4.5
Lead/Lag	Lead	Lag		Lead	Lag							
Lead-Lag Optimize?		Yes		Yes								
Vehicle Extension (s)	3.5	5.6		3.5	4.6		3.5	3.5		5.0	5.0	5.0
Minimum Gap (s)	2.0	3.6		2.0	2.6		2.0	2.0		5.0	5.0	5.0
Time Before Reduce (s)	10.0	10.0		10.0	10.0		15.0	15.0		5.0	5.0	5.0
Time To Reduce (s)	10.0	10.0		10.0	10.0		15.0	15.0		5.0	5.0	5.0
Recall Mode	None	Min		None	Min		None	None		None	None	None
Walk Time (s)		7.0			7.0		7.0	7.0		7.0	7.0	7.0
Flash Dont Walk (s)		29.0			22.0		23.0	23.0		25.0	25.0	25.0
Pedestrian Calls (#/hr)		0			0		0	0		0	0	0
Act Effct Green (s)	7.9	35.9		10.1	40.4			34.5			34.5	34.5
Actuated g/C Ratio	0.09	0.39		0.11	0.44			0.38			0.38	0.38
v/c Ratio	0.25	0.70		0.10	0.79			0.14			0.53	0.06
Control Delay	47.3	29.4		56.5	22.6			8.4			29.9	0.6
Queue Delay	0.0	1.0		0.0	0.0			0.0			0.0	0.0
Total Delay	47.3	30.4		56.5	22.6			8.4			29.9	0.6
LOS	D	C		E	C			A			C	A
Approach Delay		31.0			23.1			8.4			25.8	
Approach LOS		C			C			A			C	
Queue Length 50th (ft)	23	281		11	347			9			77	0
Queue Length 95th (ft)	49	310		m24	#473			34			145	2
Internal Link Dist (ft)		998			156			168			380	
Turn Bay Length (ft)	165											
Base Capacity (vph)	163	1340		201	1397			718			374	486
Starvation Cap Reductn	0	0		0	0			0			0	0
Spillback Cap Reductn	0	176		0	0			2			0	0
Storage Cap Reductn	0	0		0	0			0			0	0
Reduced v/c Ratio	0.23	0.81		0.08	0.78			0.12			0.44	0.06

Intersection Summary

Area Type: Other
 Cycle Length: 100
 Actuated Cycle Length: 91.2
 Natural Cycle: 100
 Control Type: Actuated-Uncoordinated
 Maximum v/c Ratio: 0.93
 Intersection Signal Delay: 26.1
 Intersection LOS: C

Lanes, Volumes, Timings

5: 6th & Brownell

11/22/2022

Intersection Capacity Utilization 49.9% ICU Level of Service A

Analysis Period (min) 15

95th percentile volume exceeds capacity, queue may be longer.

Queue shown is maximum after two cycles.

m Volume for 95th percentile queue is metered by upstream signal.



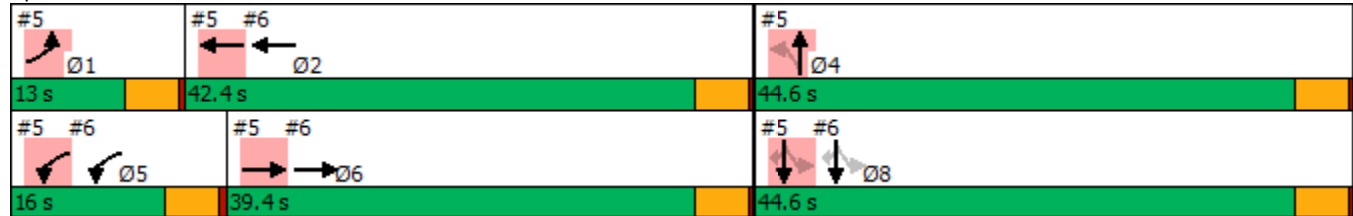













Splits and Phases: 5: 6th & Brownell



Lanes, Volumes, Timings

6: I-82 SB Entrance Ramp/I-82 SB Exit Ramp & 6th

11/22/2022

												
Lane Group	EBL	EBT	EBR	WBL	WBT	WBR	NBL	NBT	NBR	SBL	SBT	SBR
Lane Configurations												
Traffic Volume (vph)	0	825	135	85	550	0	0	0	0	390	5	425
Future Volume (vph)	0	825	135	85	550	0	0	0	0	390	5	425
Ideal Flow (vphpl)	1900	1900	1900	1900	1900	1900	1900	1900	1900	1900	1900	1900
Storage Length (ft)	0		0	110		0	0		0	0		0
Storage Lanes	0		0	1		0	0		0	0		1
Taper Length (ft)	25			45			25			25		
Lane Util. Factor	1.00	0.95	0.95	1.00	0.95	1.00	1.00	1.00	1.00	1.00	1.00	1.00
Frt		0.979										0.850
Flt Protected				0.950							0.953	
Satd. Flow (prot)	0	3047	0	1687	3374	0	0	0	0	0	1548	1380
Flt Permitted				0.950							0.953	
Satd. Flow (perm)	0	3047	0	1687	3374	0	0	0	0	0	1548	1380
Right Turn on Red			Yes			Yes			Yes			Yes
Satd. Flow (RTOR)		20										321
Link Speed (mph)		35			35			45				45
Link Distance (ft)		236			481			189				496
Travel Time (s)		4.6			9.4			2.9				7.5
Peak Hour Factor	0.85	0.85	0.85	0.91	0.91	0.91	0.92	0.92	0.92	0.93	0.93	0.93
Heavy Vehicles (%)	16%	16%	16%	7%	7%	7%	2%	2%	2%	17%	17%	17%
Adj. Flow (vph)	0	971	159	93	604	0	0	0	0	419	5	457
Shared Lane Traffic (%)												
Lane Group Flow (vph)	0	1130	0	93	604	0	0	0	0	0	424	457
Enter Blocked Intersection	No	No	No	No	No	No	No	No	No	No	No	No
Lane Alignment	Left	Right	Right	Left	Right	R NA	Left	Left	Right	Left	Left	Right
Median Width(ft)		12			12			0				0
Link Offset(ft)		0			0			0				0
Crosswalk Width(ft)		16			16			16				16
Two way Left Turn Lane												
Headway Factor	1.00	1.00	1.00	1.00	1.00	1.00	1.00	1.00	1.00	1.00	1.00	1.00
Turning Speed (mph)	15		9	15		9	15		9	15		9
Number of Detectors		2		1	2					1	2	1
Detector Template		Thru		Left	Thru					Left	Thru	Right
Leading Detector (ft)		100		20	100					20	100	20
Trailing Detector (ft)		0		0	0					0	0	0
Detector 1 Position(ft)		0		0	0					0	0	0
Detector 1 Size(ft)		6		20	6					20	6	20
Detector 1 Type		Cl+Ex		Cl+Ex	Cl+Ex					Cl+Ex	Cl+Ex	Cl+Ex
Detector 1 Channel												
Detector 1 Extend (s)		0.0		0.0	0.0					0.0	0.0	0.0
Detector 1 Queue (s)		0.0		0.0	0.0					0.0	0.0	0.0
Detector 1 Delay (s)		0.0		0.0	0.0					0.0	0.0	0.0
Detector 2 Position(ft)		94			94							94
Detector 2 Size(ft)		6			6							6
Detector 2 Type		Cl+Ex			Cl+Ex							Cl+Ex
Detector 2 Channel												
Detector 2 Extend (s)		0.0			0.0							0.0
Turn Type		NA		Prot	NA					Perm	NA	Perm
Protected Phases		6		5	2							8

Lanes, Volumes, Timings
 6: I-82 SB Entrance Ramp/I-82 SB Exit Ramp & 6th

11/22/2022

Lane Group	Ø1	Ø4
Lane Configurations		
Traffic Volume (vph)		
Future Volume (vph)		
Ideal Flow (vphpl)		
Storage Length (ft)		
Storage Lanes		
Taper Length (ft)		
Lane Util. Factor		
Frt		
Flt Protected		
Satd. Flow (prot)		
Flt Permitted		
Satd. Flow (perm)		
Right Turn on Red		
Satd. Flow (RTOR)		
Link Speed (mph)		
Link Distance (ft)		
Travel Time (s)		
Peak Hour Factor		
Heavy Vehicles (%)		
Adj. Flow (vph)		
Shared Lane Traffic (%)		
Lane Group Flow (vph)		
Enter Blocked Intersection		
Lane Alignment		
Median Width(ft)		
Link Offset(ft)		
Crosswalk Width(ft)		
Two way Left Turn Lane		
Headway Factor		
Turning Speed (mph)		
Number of Detectors		
Detector Template		
Leading Detector (ft)		
Trailing Detector (ft)		
Detector 1 Position(ft)		
Detector 1 Size(ft)		
Detector 1 Type		
Detector 1 Channel		
Detector 1 Extend (s)		
Detector 1 Queue (s)		
Detector 1 Delay (s)		
Detector 2 Position(ft)		
Detector 2 Size(ft)		
Detector 2 Type		
Detector 2 Channel		
Detector 2 Extend (s)		
Turn Type		
Protected Phases	1	4

Lanes, Volumes, Timings
6: I-82 SB Entrance Ramp/I-82 SB Exit Ramp & 6th

11/22/2022



Lane Group	EBL	EBT	EBR	WBL	WBT	WBR	NBL	NBT	NBR	SBL	SBT	SBR
Permitted Phases										8		8
Detector Phase		6		5	2					8	8	8
Switch Phase												
Minimum Initial (s)		10.0		7.0	10.0					7.0	7.0	7.0
Minimum Split (s)		40.5		13.0	36.5					44.5	44.5	44.5
Total Split (s)		39.4		16.0	42.4					44.6	44.6	44.6
Total Split (%)		39.4%		16.0%	42.4%					44.6%	44.6%	44.6%
Maximum Green (s)		34.9		11.5	37.9					40.1	40.1	40.1
Yellow Time (s)		4.0		4.0	4.0					4.0	4.0	4.0
All-Red Time (s)		0.5		0.5	0.5					0.5	0.5	0.5
Lost Time Adjust (s)		0.0		0.0	0.0						0.0	0.0
Total Lost Time (s)		4.5		4.5	4.5						4.5	4.5
Lead/Lag		Lag		Lead	Lag							
Lead-Lag Optimize?		Yes		Yes								
Vehicle Extension (s)		5.6		3.5	4.6					5.0	5.0	5.0
Minimum Gap (s)		3.6		2.0	2.6					5.0	5.0	5.0
Time Before Reduce (s)		10.0		10.0	10.0					5.0	5.0	5.0
Time To Reduce (s)		10.0		10.0	10.0					5.0	5.0	5.0
Recall Mode		Min		None	Min					None	None	None
Walk Time (s)		7.0			7.0					7.0	7.0	7.0
Flash Dont Walk (s)		29.0			22.0					25.0	25.0	25.0
Pedestrian Calls (#/hr)		0			0					0	0	0
Act Effct Green (s)		35.9		10.1	40.4						34.5	34.5
Actuated g/C Ratio		0.39		0.11	0.44						0.38	0.38
v/c Ratio		0.93		0.50	0.40						0.72	0.63
Control Delay		27.4		51.2	20.8						32.8	11.4
Queue Delay		0.1		0.0	0.1						0.0	0.2
Total Delay		27.4		51.2	20.9						32.8	11.6
LOS		C		D	C						C	B
Approach Delay		27.4			25.0						21.8	
Approach LOS		C			C						C	
Queue Length 50th (ft)		~413		56	149						218	56
Queue Length 95th (ft)		#468		108	202						332	162
Internal Link Dist (ft)		156			401			109			416	
Turn Bay Length (ft)				110								
Base Capacity (vph)		1212		219	1525						700	800
Starvation Cap Reductn		1		0	0						0	0
Spillback Cap Reductn		0		0	195						0	46
Storage Cap Reductn		0		0	0						0	0
Reduced v/c Ratio		0.93		0.42	0.45						0.61	0.61

Intersection Summary

Area Type:	Other
Cycle Length:	100
Actuated Cycle Length:	91.2
Natural Cycle:	100
Control Type:	Actuated-Uncoordinated
Maximum v/c Ratio:	0.93
Intersection Signal Delay:	25.0
Intersection LOS:	C

Lanes, Volumes, Timings
 6: I-82 SB Entrance Ramp/I-82 SB Exit Ramp & 6th

11/22/2022

Lane Group	Ø1	Ø4
Permitted Phases		
Detector Phase		
Switch Phase		
Minimum Initial (s)	7.0	7.0
Minimum Split (s)	13.0	36.5
Total Split (s)	13.0	44.6
Total Split (%)	13%	45%
Maximum Green (s)	8.5	40.1
Yellow Time (s)	4.0	4.0
All-Red Time (s)	0.5	0.5
Lost Time Adjust (s)		
Total Lost Time (s)		
Lead/Lag	Lead	
Lead-Lag Optimize?		
Vehicle Extension (s)	3.5	3.5
Minimum Gap (s)	2.0	2.0
Time Before Reduce (s)	10.0	15.0
Time To Reduce (s)	10.0	15.0
Recall Mode	None	None
Walk Time (s)		7.0
Flash Dont Walk (s)		23.0
Pedestrian Calls (#/hr)		0
Act Effct Green (s)		
Actuated g/C Ratio		
v/c Ratio		
Control Delay		
Queue Delay		
Total Delay		
LOS		
Approach Delay		
Approach LOS		
Queue Length 50th (ft)		
Queue Length 95th (ft)		
Internal Link Dist (ft)		
Turn Bay Length (ft)		
Base Capacity (vph)		
Starvation Cap Reductn		
Spillback Cap Reductn		
Storage Cap Reductn		
Reduced v/c Ratio		
Intersection Summary		

Lanes, Volumes, Timings

6: I-82 SB Entrance Ramp/I-82 SB Exit Ramp & 6th

11/22/2022

Intersection Capacity Utilization 66.1% ICU Level of Service C

Analysis Period (min) 15

~ Volume exceeds capacity, queue is theoretically infinite.

Queue shown is maximum after two cycles.

95th percentile volume exceeds capacity, queue may be longer.

Queue shown is maximum after two cycles.

Splits and Phases: 6: I-82 SB Entrance Ramp/I-82 SB Exit Ramp & 6th

<p>#5 Ø1</p>	<p>#5 #6 Ø2</p>	<p>#5 Ø4</p>
<p>13 s</p>	<p>42.4 s</p>	<p>44.6 s</p>
<p>#5 #6 Ø5</p>	<p>#5 #6 Ø6</p>	<p>#5 #6 Ø8</p>
<p>16 s</p>	<p>39.4 s</p>	<p>44.6 s</p>

Lanes, Volumes, Timings

7: I-82 NB Exit Ramp/I-82 NB Entrance Ramp & 6th

11/22/2022























Lane Group	EBL	EBT	EBR	WBL	WBT	WBR	NBL	NBT	NBR	SBL	SBT	SBR
Lane Configurations												
Traffic Volume (vph)	380	835	0	0	595	590	35	2	155	0	0	0
Future Volume (vph)	380	835	0	0	595	590	35	2	155	0	0	0
Ideal Flow (vphpl)	1900	1900	1900	1900	1900	1900	1900	1900	1900	1900	1900	1900
Storage Length (ft)	110		0	0		0	0		215	0		0
Storage Lanes	1		0	0		0	0		1	0		0
Taper Length (ft)	70			25			25			25		
Lane Util. Factor	1.00	0.95	1.00	1.00	0.95	0.95	1.00	1.00	1.00	1.00	1.00	1.00
Frt					0.925				0.850			
Flt Protected	0.950							0.954				
Satd. Flow (prot)	1719	3438	0	0	3180	0	0	1474	1313	0	0	0
Flt Permitted	0.950							0.954				
Satd. Flow (perm)	1719	3438	0	0	3180	0	0	1474	1313	0	0	0
Link Speed (mph)		35			45			45				45
Link Distance (ft)		481			3338			681				572
Travel Time (s)		9.4			50.6			10.3				8.7
Peak Hour Factor	0.80	0.80	0.80	0.85	0.85	0.85	0.82	0.82	0.82	0.92	0.92	0.92
Heavy Vehicles (%)	5%	5%	5%	5%	5%	5%	23%	23%	23%	2%	2%	2%
Adj. Flow (vph)	475	1044	0	0	700	694	43	2	189	0	0	0
Shared Lane Traffic (%)												
Lane Group Flow (vph)	475	1044	0	0	1394	0	0	45	189	0	0	0
Enter Blocked Intersection	No	No	No	No	No	No	No	No	No	No	No	No
Lane Alignment	Left	Left	Right	Left	Left	Right	Left	Left	Right	Left	Left	Right
Median Width(ft)		12			12			0				0
Link Offset(ft)		0			0			0				0
Crosswalk Width(ft)		16			16			16				16
Two way Left Turn Lane												
Headway Factor	1.00	1.00	1.00	1.00	1.00	1.00	1.00	1.00	1.00	1.00	1.00	1.00
Turning Speed (mph)	15		9	15		9	15		9	15		9
Sign Control		Free			Free			Stop				Stop

Intersection Summary

Area Type:	Other
Control Type:	Unsignalized
Intersection Capacity Utilization	69.8%
ICU Level of Service	C
Analysis Period (min)	15

Lanes, Volumes, Timings
8: Devore & 6th

11/22/2022

												
Lane Group	EBL	EBT	EBR	WBL	WBT	WBR	NBL	NBT	NBR	SBL	SBT	SBR
Lane Configurations												
Traffic Volume (vph)	10	350	0	370	605	10	575	15	310	10	20	50
Future Volume (vph)	10	350	0	370	605	10	575	15	310	10	20	50
Ideal Flow (vphpl)	1900	1900	1900	1900	1900	1900	1900	1900	1900	1900	1900	1900
Storage Length (ft)	125		0	145		0	0		0	0		0
Storage Lanes	1		0	1		0	0		1	0		0
Taper Length (ft)	60			88			25			25		
Lane Util. Factor	1.00	0.95	1.00	1.00	0.95	0.95	1.00	1.00	1.00	1.00	1.00	1.00
Frt					0.998				0.850		0.916	
Flt Protected	0.950			0.950				0.954			0.994	
Satd. Flow (prot)	1770	3539	0	1770	3532	0	0	1777	1583	0	1696	0
Flt Permitted	0.950			0.950				0.576			0.766	
Satd. Flow (perm)	1770	3539	0	1770	3532	0	0	1073	1583	0	1307	0
Right Turn on Red			Yes			Yes			Yes			Yes
Satd. Flow (RTOR)					1				265		77	
Link Speed (mph)		45			45			45			45	
Link Distance (ft)		343			889			455			382	
Travel Time (s)		5.2			13.5			6.9			5.8	
Peak Hour Factor	0.82	0.82	0.82	0.72	0.72	0.72	0.90	0.90	0.90	0.42	0.42	0.42
Adj. Flow (vph)	12	427	0	514	840	14	639	17	344	24	48	119
Shared Lane Traffic (%)												
Lane Group Flow (vph)	12	427	0	514	854	0	0	656	344	0	191	0
Enter Blocked Intersection	No	No	No	No	No	No	No	No	No	No	No	No
Lane Alignment	Left	Left	Right	Left	Left	Right	Left	Left	Right	Left	Left	Right
Median Width(ft)		12			12			0			0	
Link Offset(ft)		0			0			0			0	
Crosswalk Width(ft)		16			16			16			16	
Two way Left Turn Lane												
Headway Factor	1.00	1.00	1.00	1.00	1.00	1.00	1.00	1.00	1.00	1.00	1.00	1.00
Turning Speed (mph)	15		9	15		9	15		9	15		9
Number of Detectors	1	2		1	2		1	2	1	1	2	
Detector Template	Left	Thru		Left	Thru		Left	Thru	Right	Left	Thru	
Leading Detector (ft)	20	100		20	100		20	100	20	20	100	
Trailing Detector (ft)	0	0		0	0		0	0	0	0	0	
Detector 1 Position(ft)	0	0		0	0		0	0	0	0	0	
Detector 1 Size(ft)	20	6		20	6		20	6	20	20	6	
Detector 1 Type	Cl+Ex	Cl+Ex		Cl+Ex	Cl+Ex		Cl+Ex	Cl+Ex	Cl+Ex	Cl+Ex	Cl+Ex	
Detector 1 Channel												
Detector 1 Extend (s)	0.0	0.0		0.0	0.0		0.0	0.0	0.0	0.0	0.0	
Detector 1 Queue (s)	0.0	0.0		0.0	0.0		0.0	0.0	0.0	0.0	0.0	
Detector 1 Delay (s)	0.0	0.0		0.0	0.0		0.0	0.0	0.0	0.0	0.0	
Detector 2 Position(ft)		94			94			94			94	
Detector 2 Size(ft)		6			6			6			6	
Detector 2 Type		Cl+Ex			Cl+Ex			Cl+Ex			Cl+Ex	
Detector 2 Channel												
Detector 2 Extend (s)		0.0			0.0			0.0			0.0	
Turn Type	Prot	NA		Prot	NA		Perm	NA	Perm	Perm	NA	
Protected Phases	5	2		1	6			8			4	
Permitted Phases							8		8	4		

Lanes, Volumes, Timings

8: Devore & 6th

11/22/2022



Lane Group	EBL	EBT	EBR	WBL	WBT	WBR	NBL	NBT	NBR	SBL	SBT	SBR
Detector Phase	5	2		1	6		8	8	8	4	4	
Switch Phase												
Minimum Initial (s)	8.0	10.0		8.0	10.0		8.0	8.0	8.0	7.0	7.0	
Minimum Split (s)	13.0	36.5		13.0	31.5		46.5	46.5	46.5	36.5	36.5	
Total Split (s)	13.0	38.0		35.0	60.0		77.0	77.0	77.0	77.0	77.0	
Total Split (%)	8.7%	25.3%		23.3%	40.0%		51.3%	51.3%	51.3%	51.3%	51.3%	
Maximum Green (s)	8.5	32.5		30.5	54.5		71.5	71.5	71.5	72.5	72.5	
Yellow Time (s)	4.0	5.0		4.0	5.0		5.0	5.0	5.0	4.0	4.0	
All-Red Time (s)	0.5	0.5		0.5	0.5		0.5	0.5	0.5	0.5	0.5	
Lost Time Adjust (s)	0.0	0.0		0.0	0.0		0.0	0.0	0.0		0.0	
Total Lost Time (s)	4.5	5.5		4.5	5.5		5.5	5.5	5.5		4.5	
Lead/Lag	Lead	Lag		Lead	Lag							
Lead-Lag Optimize?	Yes	Yes		Yes	Yes							
Vehicle Extension (s)	2.5	7.0		3.5	5.4		3.5	3.5	3.5	2.5	2.5	
Minimum Gap (s)	1.0	3.4		2.5	3.4		1.5	1.5	1.5	1.0	1.0	
Time Before Reduce (s)	5.0	15.0		5.0	15.0		10.0	10.0	10.0	5.0	5.0	
Time To Reduce (s)	5.0	15.0		5.0	15.0		10.0	10.0	10.0	5.0	5.0	
Recall Mode	None	Min		None	Min		None	None	None	None	None	
Walk Time (s)		7.0			7.0		7.0	7.0	7.0	7.0	7.0	
Flash Dont Walk (s)		24.0			19.0		34.0	34.0	34.0	25.0	25.0	
Pedestrian Calls (#/hr)		0			0		0	0	0	0	0	
Act Effct Green (s)	8.0	26.2		30.5	56.4		71.5	71.5	71.5		72.5	
Actuated g/C Ratio	0.06	0.18		0.21	0.39		0.50	0.50	0.50		0.50	
v/c Ratio	0.12	0.66		1.37	0.62		1.23	0.37	0.37		0.27	
Control Delay	69.3	59.9		224.9	38.1		152.0	6.6	6.6		13.5	
Queue Delay	0.0	0.0		0.0	0.0		0.0	0.0	0.0		0.0	
Total Delay	69.3	59.9		224.9	38.1		152.0	6.6	6.6		13.5	
LOS	E	E		F	D		F	A	A		B	
Approach Delay		60.1			108.3		102.0				13.5	
Approach LOS		E			F		F				B	
Queue Length 50th (ft)	11	197		~631	314		~753	38	38		57	
Queue Length 95th (ft)	32	230		#653	327		#1055	110	110		26	
Internal Link Dist (ft)		263			809		375				302	
Turn Bay Length (ft)	125			145								
Base Capacity (vph)	104	800		375	1403		533	920	920		697	
Starvation Cap Reductn	0	0		0	0		0	0	0		0	
Spillback Cap Reductn	0	0		0	0		0	0	0		0	
Storage Cap Reductn	0	0		0	0		0	0	0		0	
Reduced v/c Ratio	0.12	0.53		1.37	0.61		1.23	0.37	0.37		0.27	

Intersection Summary

Area Type:	Other
Cycle Length:	150
Actuated Cycle Length:	143.8
Natural Cycle:	150
Control Type:	Actuated-Uncoordinated
Maximum v/c Ratio:	1.37
Intersection Signal Delay:	93.1
Intersection Capacity Utilization:	82.4%
Intersection LOS:	F
ICU Level of Service:	E

Analysis Period (min) 15

~ Volume exceeds capacity, queue is theoretically infinite.

Queue shown is maximum after two cycles.

95th percentile volume exceeds capacity, queue may be longer.





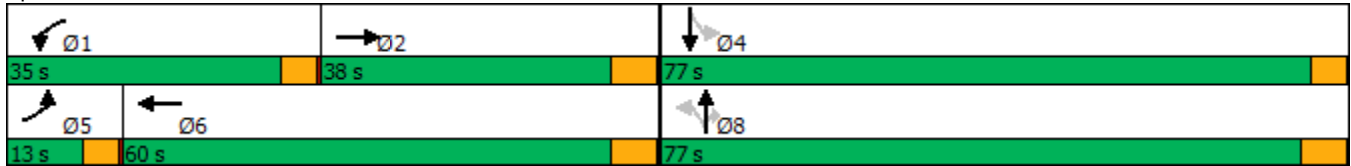













Queue shown is maximum after two cycles.

Splits and Phases: 8: Devore & 6th



Lanes, Volumes, Timings
5: 6th & Brownell

11/22/2022

												
Lane Group	EBL	EBT	EBR	WBL	WBT	WBR	NBL	NBT	NBR	SBL	SBT	SBR
Lane Configurations												
Traffic Volume (vph)	30	760	5	15	900	65	15	5	50	150	5	25
Future Volume (vph)	30	760	5	15	900	65	15	5	50	150	5	25
Ideal Flow (vphpl)	1900	1900	1900	1900	1900	1900	1900	1900	1900	1900	1900	1900
Storage Length (ft)	165		0	0		0	0		0	0		0
Storage Lanes	1		0	1		0	0		0	0		1
Taper Length (ft)	135			25			25			25		
Lane Util. Factor	1.00	0.95	0.95	1.00	0.95	0.95	1.00	1.00	1.00	1.00	1.00	1.00
Frt		0.999			0.990			0.904				0.850
Flt Protected	0.950			0.950				0.989			0.954	
Satd. Flow (prot)	1703	3402	0	1556	3081	0	0	1603	0	0	1119	997
Flt Permitted	0.950			0.950				0.935			0.706	
Satd. Flow (perm)	1703	3402	0	1556	3081	0	0	1515	0	0	828	997
Right Turn on Red			Yes			Yes			Yes			Yes
Satd. Flow (RTOR)		1			8			60				65
Link Speed (mph)		35			35			30				30
Link Distance (ft)		1078			236			248				460
Travel Time (s)		21.0			4.6			5.6				10.5
Peak Hour Factor	0.81	0.81	0.81	0.89	0.89	0.89	0.84	0.84	0.84	0.93	0.93	0.93
Heavy Vehicles (%)	6%	6%	6%	16%	16%	16%	6%	6%	6%	62%	62%	62%
Adj. Flow (vph)	37	938	6	17	1011	73	18	6	60	161	5	27
Shared Lane Traffic (%)												
Lane Group Flow (vph)	37	944	0	17	1084	0	0	84	0	0	166	27
Enter Blocked Intersection	No	No	No	No	No	No	No	No	No	No	No	No
Lane Alignment	Left	Left	Right	Left	Left	Right	Left	Left	Right	Left	Left	Right
Median Width(ft)		12			12			0				0
Link Offset(ft)		0			0			0				0
Crosswalk Width(ft)		16			16			16				16
Two way Left Turn Lane												
Headway Factor	1.00	1.00	1.00	1.00	1.00	1.00	1.00	1.00	1.00	1.00	1.00	1.00
Turning Speed (mph)	15		9	15		9	15		9	15		9
Number of Detectors	1	2		1	2		1	2		1	2	1
Detector Template	Left	Thru		Left	Thru		Left	Thru		Left	Thru	Right
Leading Detector (ft)	20	100		20	100		20	100		20	100	20
Trailing Detector (ft)	0	0		0	0		0	0		0	0	0
Detector 1 Position(ft)	0	0		0	0		0	0		0	0	0
Detector 1 Size(ft)	20	6		20	6		20	6		20	6	20
Detector 1 Type	Cl+Ex	Cl+Ex		Cl+Ex	Cl+Ex		Cl+Ex	Cl+Ex		Cl+Ex	Cl+Ex	Cl+Ex
Detector 1 Channel												
Detector 1 Extend (s)	0.0	0.0		0.0	0.0		0.0	0.0		0.0	0.0	0.0
Detector 1 Queue (s)	0.0	0.0		0.0	0.0		0.0	0.0		0.0	0.0	0.0
Detector 1 Delay (s)	0.0	0.0		0.0	0.0		0.0	0.0		0.0	0.0	0.0
Detector 2 Position(ft)		94			94			94				94
Detector 2 Size(ft)		6			6			6				6
Detector 2 Type		Cl+Ex			Cl+Ex			Cl+Ex				Cl+Ex
Detector 2 Channel												
Detector 2 Extend (s)		0.0			0.0			0.0				0.0
Turn Type	Prot	NA		Prot	NA		Perm	NA		Perm	NA	Perm
Protected Phases	1	6		5	2			4				8

Lanes, Volumes, Timings
5: 6th & Brownell

11/22/2022



Lane Group	EBL	EBT	EBR	WBL	WBT	WBR	NBL	NBT	NBR	SBL	SBT	SBR
Permitted Phases							4			8		8
Detector Phase	1	6		5	2		4	4		8	8	8
Switch Phase												
Minimum Initial (s)	7.0	10.0		7.0	10.0		7.0	7.0		7.0	7.0	7.0
Minimum Split (s)	13.0	40.5		13.0	36.5		36.5	36.5		44.5	44.5	44.5
Total Split (s)	13.0	39.4		16.0	42.4		44.6	44.6		44.6	44.6	44.6
Total Split (%)	13.0%	39.4%		16.0%	42.4%		44.6%	44.6%		44.6%	44.6%	44.6%
Maximum Green (s)	8.5	34.9		11.5	37.9		40.1	40.1		40.1	40.1	40.1
Yellow Time (s)	4.0	4.0		4.0	4.0		4.0	4.0		4.0	4.0	4.0
All-Red Time (s)	0.5	0.5		0.5	0.5		0.5	0.5		0.5	0.5	0.5
Lost Time Adjust (s)	0.0	0.0		0.0	0.0			0.0			0.0	0.0
Total Lost Time (s)	4.5	4.5		4.5	4.5			4.5			4.5	4.5
Lead/Lag	Lead	Lag		Lead	Lag							
Lead-Lag Optimize?		Yes		Yes								
Vehicle Extension (s)	3.5	5.6		3.5	4.6		3.5	3.5		5.0	5.0	5.0
Minimum Gap (s)	2.0	3.6		2.0	2.6		2.0	2.0		5.0	5.0	5.0
Time Before Reduce (s)	10.0	10.0		10.0	10.0		15.0	15.0		5.0	5.0	5.0
Time To Reduce (s)	10.0	10.0		10.0	10.0		15.0	15.0		5.0	5.0	5.0
Recall Mode	None	Min		None	Min		None	None		None	None	None
Walk Time (s)		7.0			7.0		7.0	7.0		7.0	7.0	7.0
Flash Dont Walk (s)		29.0			22.0		23.0	23.0		25.0	25.0	25.0
Pedestrian Calls (#/hr)		0			0		0	0		0	0	0
Act Effct Green (s)	7.9	35.9		10.1	40.4			34.5			34.5	34.5
Actuated g/C Ratio	0.09	0.39		0.11	0.44			0.38			0.38	0.38
v/c Ratio	0.25	0.70		0.10	0.79			0.14			0.53	0.06
Control Delay	47.3	29.4		56.5	22.6			8.4			29.9	0.6
Queue Delay	0.0	1.0		0.0	0.0			0.0			0.0	0.0
Total Delay	47.3	30.4		56.5	22.6			8.4			29.9	0.6
LOS	D	C		E	C			A			C	A
Approach Delay		31.0			23.1			8.4			25.8	
Approach LOS		C			C			A			C	
Queue Length 50th (ft)	23	281		11	347			9			77	0
Queue Length 95th (ft)	49	310		m24	#473			34			145	2
Internal Link Dist (ft)		998			156			168			380	
Turn Bay Length (ft)	165											
Base Capacity (vph)	163	1340		201	1397			718			374	486
Starvation Cap Reductn	0	0		0	0			0			0	0
Spillback Cap Reductn	0	176		0	0			2			0	0
Storage Cap Reductn	0	0		0	0			0			0	0
Reduced v/c Ratio	0.23	0.81		0.08	0.78			0.12			0.44	0.06

Intersection Summary

Area Type:	Other
Cycle Length:	100
Actuated Cycle Length:	91.2
Natural Cycle:	100
Control Type:	Actuated-Uncoordinated
Maximum v/c Ratio:	0.93
Intersection Signal Delay:	26.1
Intersection LOS:	C

Lanes, Volumes, Timings

5: 6th & Brownell

11/22/2022

Intersection Capacity Utilization 49.9% ICU Level of Service A

Analysis Period (min) 15

95th percentile volume exceeds capacity, queue may be longer.

Queue shown is maximum after two cycles.

m Volume for 95th percentile queue is metered by upstream signal.



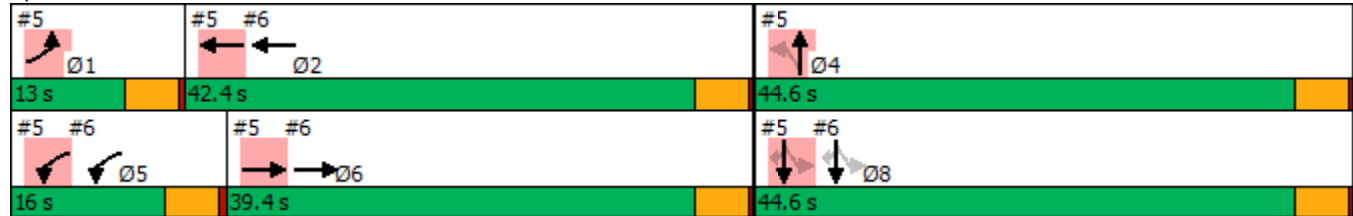













Splits and Phases: 5: 6th & Brownell



Lanes, Volumes, Timings

6: I-82 SB Entrance Ramp/I-82 SB Exit Ramp & 6th

11/22/2022

												
Lane Group	EBL	EBT	EBR	WBL	WBT	WBR	NBL	NBT	NBR	SBL	SBT	SBR
Lane Configurations												
Traffic Volume (vph)	0	825	135	85	550	0	0	0	0	390	5	425
Future Volume (vph)	0	825	135	85	550	0	0	0	0	390	5	425
Ideal Flow (vphpl)	1900	1900	1900	1900	1900	1900	1900	1900	1900	1900	1900	1900
Storage Length (ft)	0		0	110		0	0		0	0		0
Storage Lanes	0		0	1		0	0		0	0		1
Taper Length (ft)	25			45			25			25		
Lane Util. Factor	1.00	0.95	0.95	1.00	0.95	1.00	1.00	1.00	1.00	1.00	1.00	1.00
Frt		0.979										0.850
Flt Protected				0.950							0.953	
Satd. Flow (prot)	0	3047	0	1687	3374	0	0	0	0	0	1548	1380
Flt Permitted				0.950							0.953	
Satd. Flow (perm)	0	3047	0	1687	3374	0	0	0	0	0	1548	1380
Right Turn on Red			Yes			Yes			Yes			Yes
Satd. Flow (RTOR)		20										321
Link Speed (mph)		35			35			45				45
Link Distance (ft)		236			481			189				496
Travel Time (s)		4.6			9.4			2.9				7.5
Peak Hour Factor	0.85	0.85	0.85	0.91	0.91	0.91	0.92	0.92	0.92	0.93	0.93	0.93
Heavy Vehicles (%)	16%	16%	16%	7%	7%	7%	2%	2%	2%	17%	17%	17%
Adj. Flow (vph)	0	971	159	93	604	0	0	0	0	419	5	457
Shared Lane Traffic (%)												
Lane Group Flow (vph)	0	1130	0	93	604	0	0	0	0	0	424	457
Enter Blocked Intersection	No	No	No	No	No	No	No	No	No	No	No	No
Lane Alignment	Left	Right	Right	Left	Right	R NA	Left	Left	Right	Left	Left	Right
Median Width(ft)		12			12			0				0
Link Offset(ft)		0			0			0				0
Crosswalk Width(ft)		16			16			16				16
Two way Left Turn Lane												
Headway Factor	1.00	1.00	1.00	1.00	1.00	1.00	1.00	1.00	1.00	1.00	1.00	1.00
Turning Speed (mph)	15		9	15		9	15		9	15		9
Number of Detectors		2		1	2					1	2	1
Detector Template		Thru		Left	Thru					Left	Thru	Right
Leading Detector (ft)		100		20	100					20	100	20
Trailing Detector (ft)		0		0	0					0	0	0
Detector 1 Position(ft)		0		0	0					0	0	0
Detector 1 Size(ft)		6		20	6					20	6	20
Detector 1 Type		Cl+Ex		Cl+Ex	Cl+Ex					Cl+Ex	Cl+Ex	Cl+Ex
Detector 1 Channel												
Detector 1 Extend (s)		0.0		0.0	0.0					0.0	0.0	0.0
Detector 1 Queue (s)		0.0		0.0	0.0					0.0	0.0	0.0
Detector 1 Delay (s)		0.0		0.0	0.0					0.0	0.0	0.0
Detector 2 Position(ft)		94			94							94
Detector 2 Size(ft)		6			6							6
Detector 2 Type		Cl+Ex			Cl+Ex							Cl+Ex
Detector 2 Channel												
Detector 2 Extend (s)		0.0			0.0							0.0
Turn Type		NA		Prot	NA					Perm	NA	Perm
Protected Phases		6		5	2							8

Lanes, Volumes, Timings
 6: I-82 SB Entrance Ramp/I-82 SB Exit Ramp & 6th

11/22/2022

Lane Group	Ø1	Ø4
Lane Configurations		
Traffic Volume (vph)		
Future Volume (vph)		
Ideal Flow (vphpl)		
Storage Length (ft)		
Storage Lanes		
Taper Length (ft)		
Lane Util. Factor		
Frt		
Flt Protected		
Satd. Flow (prot)		
Flt Permitted		
Satd. Flow (perm)		
Right Turn on Red		
Satd. Flow (RTOR)		
Link Speed (mph)		
Link Distance (ft)		
Travel Time (s)		
Peak Hour Factor		
Heavy Vehicles (%)		
Adj. Flow (vph)		
Shared Lane Traffic (%)		
Lane Group Flow (vph)		
Enter Blocked Intersection		
Lane Alignment		
Median Width(ft)		
Link Offset(ft)		
Crosswalk Width(ft)		
Two way Left Turn Lane		
Headway Factor		
Turning Speed (mph)		
Number of Detectors		
Detector Template		
Leading Detector (ft)		
Trailing Detector (ft)		
Detector 1 Position(ft)		
Detector 1 Size(ft)		
Detector 1 Type		
Detector 1 Channel		
Detector 1 Extend (s)		
Detector 1 Queue (s)		
Detector 1 Delay (s)		
Detector 2 Position(ft)		
Detector 2 Size(ft)		
Detector 2 Type		
Detector 2 Channel		
Detector 2 Extend (s)		
Turn Type		
Protected Phases	1	4

Lanes, Volumes, Timings
6: I-82 SB Entrance Ramp/I-82 SB Exit Ramp & 6th

11/22/2022



Lane Group	EBL	EBT	EBR	WBL	WBT	WBR	NBL	NBT	NBR	SBL	SBT	SBR
Permitted Phases										8		8
Detector Phase		6		5	2					8	8	8
Switch Phase												
Minimum Initial (s)		10.0		7.0	10.0					7.0	7.0	7.0
Minimum Split (s)		40.5		13.0	36.5					44.5	44.5	44.5
Total Split (s)		39.4		16.0	42.4					44.6	44.6	44.6
Total Split (%)		39.4%		16.0%	42.4%					44.6%	44.6%	44.6%
Maximum Green (s)		34.9		11.5	37.9					40.1	40.1	40.1
Yellow Time (s)		4.0		4.0	4.0					4.0	4.0	4.0
All-Red Time (s)		0.5		0.5	0.5					0.5	0.5	0.5
Lost Time Adjust (s)		0.0		0.0	0.0						0.0	0.0
Total Lost Time (s)		4.5		4.5	4.5						4.5	4.5
Lead/Lag		Lag		Lead	Lag							
Lead-Lag Optimize?		Yes		Yes								
Vehicle Extension (s)		5.6		3.5	4.6					5.0	5.0	5.0
Minimum Gap (s)		3.6		2.0	2.6					5.0	5.0	5.0
Time Before Reduce (s)		10.0		10.0	10.0					5.0	5.0	5.0
Time To Reduce (s)		10.0		10.0	10.0					5.0	5.0	5.0
Recall Mode		Min		None	Min					None	None	None
Walk Time (s)		7.0			7.0					7.0	7.0	7.0
Flash Dont Walk (s)		29.0			22.0					25.0	25.0	25.0
Pedestrian Calls (#/hr)		0			0					0	0	0
Act Effct Green (s)		35.9		10.1	40.4						34.5	34.5
Actuated g/C Ratio		0.39		0.11	0.44						0.38	0.38
v/c Ratio		0.93		0.50	0.40						0.72	0.63
Control Delay		27.4		51.2	20.8						32.8	11.4
Queue Delay		0.1		0.0	0.1						0.0	0.2
Total Delay		27.4		51.2	20.9						32.8	11.6
LOS		C		D	C						C	B
Approach Delay		27.4			25.0						21.8	
Approach LOS		C			C						C	
Queue Length 50th (ft)		~413		56	149						218	56
Queue Length 95th (ft)		#468		108	202						332	162
Internal Link Dist (ft)		156			401			109			416	
Turn Bay Length (ft)				110								
Base Capacity (vph)		1212		219	1525						700	800
Starvation Cap Reductn		1		0	0						0	0
Spillback Cap Reductn		0		0	195						0	46
Storage Cap Reductn		0		0	0						0	0
Reduced v/c Ratio		0.93		0.42	0.45						0.61	0.61

Intersection Summary

Area Type:	Other
Cycle Length:	100
Actuated Cycle Length:	91.2
Natural Cycle:	100
Control Type:	Actuated-Uncoordinated
Maximum v/c Ratio:	0.93
Intersection Signal Delay:	25.0
Intersection LOS:	C

Lanes, Volumes, Timings
 6: I-82 SB Entrance Ramp/I-82 SB Exit Ramp & 6th

11/22/2022

Lane Group	Ø1	Ø4
Permitted Phases		
Detector Phase		
Switch Phase		
Minimum Initial (s)	7.0	7.0
Minimum Split (s)	13.0	36.5
Total Split (s)	13.0	44.6
Total Split (%)	13%	45%
Maximum Green (s)	8.5	40.1
Yellow Time (s)	4.0	4.0
All-Red Time (s)	0.5	0.5
Lost Time Adjust (s)		
Total Lost Time (s)		
Lead/Lag	Lead	
Lead-Lag Optimize?		
Vehicle Extension (s)	3.5	3.5
Minimum Gap (s)	2.0	2.0
Time Before Reduce (s)	10.0	15.0
Time To Reduce (s)	10.0	15.0
Recall Mode	None	None
Walk Time (s)		7.0
Flash Dont Walk (s)		23.0
Pedestrian Calls (#/hr)		0
Act Effct Green (s)		
Actuated g/C Ratio		
v/c Ratio		
Control Delay		
Queue Delay		
Total Delay		
LOS		
Approach Delay		
Approach LOS		
Queue Length 50th (ft)		
Queue Length 95th (ft)		
Internal Link Dist (ft)		
Turn Bay Length (ft)		
Base Capacity (vph)		
Starvation Cap Reductn		
Spillback Cap Reductn		
Storage Cap Reductn		
Reduced v/c Ratio		
Intersection Summary		

Lanes, Volumes, Timings

6: I-82 SB Entrance Ramp/I-82 SB Exit Ramp & 6th

11/22/2022

Intersection Capacity Utilization 66.1% ICU Level of Service C

Analysis Period (min) 15

~ Volume exceeds capacity, queue is theoretically infinite.

Queue shown is maximum after two cycles.

95th percentile volume exceeds capacity, queue may be longer.

Queue shown is maximum after two cycles.

Splits and Phases: 6: I-82 SB Entrance Ramp/I-82 SB Exit Ramp & 6th

<p>#5 Ø1</p>	<p>#5 #6 Ø2</p>	<p>#5 Ø4</p>
13 s	42.4 s	44.6 s
<p>#5 #6 Ø5</p>	<p>#5 #6 Ø6</p>	<p>#5 #6 Ø8</p>
16 s	39.4 s	44.6 s

Lanes, Volumes, Timings

7: I-82 NB Exit Ramp/I-82 NB Entrance Ramp & 6th

11/22/2022























Lane Group	EBL	EBT	EBR	WBL	WBT	WBR	NBL	NBT	NBR	SBL	SBT	SBR
Lane Configurations												
Traffic Volume (vph)	380	835	0	0	595	590	35	2	155	0	0	0
Future Volume (vph)	380	835	0	0	595	590	35	2	155	0	0	0
Ideal Flow (vphpl)	1900	1900	1900	1900	1900	1900	1900	1900	1900	1900	1900	1900
Storage Length (ft)	110		0	0		0	0		215	0		0
Storage Lanes	1		0	0		0	0		1	0		0
Taper Length (ft)	70			25			25			25		
Lane Util. Factor	1.00	0.95	1.00	1.00	0.95	0.95	1.00	1.00	1.00	1.00	1.00	1.00
Frt					0.925				0.850			
Flt Protected	0.950							0.954				
Satd. Flow (prot)	1719	3438	0	0	3180	0	0	1474	1313	0	0	0
Flt Permitted	0.950							0.954				
Satd. Flow (perm)	1719	3438	0	0	3180	0	0	1474	1313	0	0	0
Link Speed (mph)		35			45			45				45
Link Distance (ft)		481			3338			681				572
Travel Time (s)		9.4			50.6			10.3				8.7
Peak Hour Factor	0.80	0.80	0.80	0.85	0.85	0.85	0.82	0.82	0.82	0.92	0.92	0.92
Heavy Vehicles (%)	5%	5%	5%	5%	5%	5%	23%	23%	23%	2%	2%	2%
Adj. Flow (vph)	475	1044	0	0	700	694	43	2	189	0	0	0
Shared Lane Traffic (%)												
Lane Group Flow (vph)	475	1044	0	0	1394	0	0	45	189	0	0	0
Enter Blocked Intersection	No	No	No	No	No	No	No	No	No	No	No	No
Lane Alignment	Left	Left	Right	Left	Left	Right	Left	Left	Right	Left	Left	Right
Median Width(ft)		12			12			0				0
Link Offset(ft)		0			0			0				0
Crosswalk Width(ft)		16			16			16				16
Two way Left Turn Lane												
Headway Factor	1.00	1.00	1.00	1.00	1.00	1.00	1.00	1.00	1.00	1.00	1.00	1.00
Turning Speed (mph)	15		9	15		9	15		9	15		9
Sign Control		Free			Free			Stop				Stop

Intersection Summary

Area Type:	Other
Control Type:	Unsignalized
Intersection Capacity Utilization	69.8%
ICU Level of Service	C
Analysis Period (min)	15

Lanes, Volumes, Timings
8: Devore & 6th

11/22/2022

												
Lane Group	EBL	EBT	EBR	WBL	WBT	WBR	NBL	NBT	NBR	SBL	SBT	SBR
Lane Configurations												
Traffic Volume (vph)	10	350	0	370	605	10	575	15	310	10	20	50
Future Volume (vph)	10	350	0	370	605	10	575	15	310	10	20	50
Ideal Flow (vphpl)	1900	1900	1900	1900	1900	1900	1900	1900	1900	1900	1900	1900
Storage Length (ft)	125		0	145		0	0		0	0		0
Storage Lanes	1		0	1		0	0		1	0		0
Taper Length (ft)	60			88			25			25		
Lane Util. Factor	1.00	0.95	1.00	1.00	0.95	0.95	1.00	1.00	1.00	1.00	1.00	1.00
Frt					0.998				0.850		0.916	
Flt Protected	0.950			0.950				0.954			0.994	
Satd. Flow (prot)	1770	3539	0	1770	3532	0	0	1777	1583	0	1696	0
Flt Permitted	0.950			0.950				0.576			0.766	
Satd. Flow (perm)	1770	3539	0	1770	3532	0	0	1073	1583	0	1307	0
Right Turn on Red			Yes			Yes			Yes			Yes
Satd. Flow (RTOR)					1				265		77	
Link Speed (mph)		45		45				45		45		45
Link Distance (ft)		343		889				455		382		382
Travel Time (s)		5.2		13.5				6.9		5.8		5.8
Peak Hour Factor	0.82	0.82	0.82	0.72	0.72	0.72	0.90	0.90	0.90	0.42	0.42	0.42
Adj. Flow (vph)	12	427	0	514	840	14	639	17	344	24	48	119
Shared Lane Traffic (%)												
Lane Group Flow (vph)	12	427	0	514	854	0	0	656	344	0	191	0
Enter Blocked Intersection	No	No	No	No	No	No	No	No	No	No	No	No
Lane Alignment	Left	Left	Right	Left	Left	Right	Left	Left	Right	Left	Left	Right
Median Width(ft)		12		12				0		0		0
Link Offset(ft)		0		0				0		0		0
Crosswalk Width(ft)		16		16				16		16		16
Two way Left Turn Lane												
Headway Factor	1.00	1.00	1.00	1.00	1.00	1.00	1.00	1.00	1.00	1.00	1.00	1.00
Turning Speed (mph)	15		9	15		9	15		9	15		9
Number of Detectors	1	2		1	2		1	2	1	1		2
Detector Template	Left	Thru		Left	Thru		Left	Thru	Right	Left		Thru
Leading Detector (ft)	20	100		20	100		20	100	20	20		100
Trailing Detector (ft)	0	0		0	0		0	0	0	0		0
Detector 1 Position(ft)	0	0		0	0		0	0	0	0		0
Detector 1 Size(ft)	20	6		20	6		20	6	20	20		6
Detector 1 Type	Cl+Ex	Cl+Ex		Cl+Ex	Cl+Ex		Cl+Ex	Cl+Ex	Cl+Ex	Cl+Ex		Cl+Ex
Detector 1 Channel												
Detector 1 Extend (s)	0.0	0.0		0.0	0.0		0.0	0.0	0.0	0.0		0.0
Detector 1 Queue (s)	0.0	0.0		0.0	0.0		0.0	0.0	0.0	0.0		0.0
Detector 1 Delay (s)	0.0	0.0		0.0	0.0		0.0	0.0	0.0	0.0		0.0
Detector 2 Position(ft)		94		94			94					94
Detector 2 Size(ft)		6		6			6					6
Detector 2 Type		Cl+Ex		Cl+Ex			Cl+Ex					Cl+Ex
Detector 2 Channel												
Detector 2 Extend (s)		0.0		0.0			0.0					0.0
Turn Type	Prot	NA		Prot	NA		Perm	NA	Perm	Perm		NA
Protected Phases	5	2		1	6		8	8		4		4
Permitted Phases							8		8	4		

Lanes, Volumes, Timings

8: Devore & 6th

11/22/2022



Lane Group	EBL	EBT	EBR	WBL	WBT	WBR	NBL	NBT	NBR	SBL	SBT	SBR
Detector Phase	5	2		1	6		8	8	8	4	4	
Switch Phase												
Minimum Initial (s)	8.0	10.0		8.0	10.0		8.0	8.0	8.0	7.0	7.0	
Minimum Split (s)	13.0	36.5		13.0	31.5		46.5	46.5	46.5	36.5	36.5	
Total Split (s)	13.0	38.0		35.0	60.0		77.0	77.0	77.0	77.0	77.0	
Total Split (%)	8.7%	25.3%		23.3%	40.0%		51.3%	51.3%	51.3%	51.3%	51.3%	
Maximum Green (s)	8.5	32.5		30.5	54.5		71.5	71.5	71.5	72.5	72.5	
Yellow Time (s)	4.0	5.0		4.0	5.0		5.0	5.0	5.0	4.0	4.0	
All-Red Time (s)	0.5	0.5		0.5	0.5		0.5	0.5	0.5	0.5	0.5	
Lost Time Adjust (s)	0.0	0.0		0.0	0.0		0.0	0.0	0.0		0.0	
Total Lost Time (s)	4.5	5.5		4.5	5.5		5.5	5.5	5.5		4.5	
Lead/Lag	Lead	Lag		Lead	Lag							
Lead-Lag Optimize?	Yes	Yes		Yes	Yes							
Vehicle Extension (s)	2.5	7.0		3.5	5.4		3.5	3.5	3.5	2.5	2.5	
Minimum Gap (s)	1.0	3.4		2.5	3.4		1.5	1.5	1.5	1.0	1.0	
Time Before Reduce (s)	5.0	15.0		5.0	15.0		10.0	10.0	10.0	5.0	5.0	
Time To Reduce (s)	5.0	15.0		5.0	15.0		10.0	10.0	10.0	5.0	5.0	
Recall Mode	None	Min		None	Min		None	None	None	None	None	
Walk Time (s)		7.0			7.0		7.0	7.0	7.0	7.0	7.0	
Flash Dont Walk (s)		24.0			19.0		34.0	34.0	34.0	25.0	25.0	
Pedestrian Calls (#/hr)		0			0		0	0	0	0	0	
Act Effct Green (s)	8.0	26.2		30.5	56.4		71.5	71.5	71.5		72.5	
Actuated g/C Ratio	0.06	0.18		0.21	0.39		0.50	0.50	0.50		0.50	
v/c Ratio	0.12	0.66		1.37	0.62		1.23	0.37	0.37		0.27	
Control Delay	69.3	59.9		224.9	38.1		152.0	6.6	6.6		13.5	
Queue Delay	0.0	0.0		0.0	0.0		0.0	0.0	0.0		0.0	
Total Delay	69.3	59.9		224.9	38.1		152.0	6.6	6.6		13.5	
LOS	E	E		F	D		F	A	A		B	
Approach Delay		60.1			108.3		102.0				13.5	
Approach LOS		E			F		F				B	
Queue Length 50th (ft)	11	197		~631	314		~753	38	38		57	
Queue Length 95th (ft)	32	230		#653	327		#1055	110	110		26	
Internal Link Dist (ft)		263			809		375				302	
Turn Bay Length (ft)	125			145								
Base Capacity (vph)	104	800		375	1403		533	920	920		697	
Starvation Cap Reductn	0	0		0	0		0	0	0		0	
Spillback Cap Reductn	0	0		0	0		0	0	0		0	
Storage Cap Reductn	0	0		0	0		0	0	0		0	
Reduced v/c Ratio	0.12	0.53		1.37	0.61		1.23	0.37	0.37		0.27	

Intersection Summary

Area Type:	Other
Cycle Length:	150
Actuated Cycle Length:	143.8
Natural Cycle:	150
Control Type:	Actuated-Uncoordinated
Maximum v/c Ratio:	1.37
Intersection Signal Delay:	93.1
Intersection Capacity Utilization:	82.4%
Intersection LOS:	F
ICU Level of Service:	E

Analysis Period (min) 15

~ Volume exceeds capacity, queue is theoretically infinite.

Queue shown is maximum after two cycles.

95th percentile volume exceeds capacity, queue may be longer.

Queue shown is maximum after two cycles.

Splits and Phases: 8: Devore & 6th

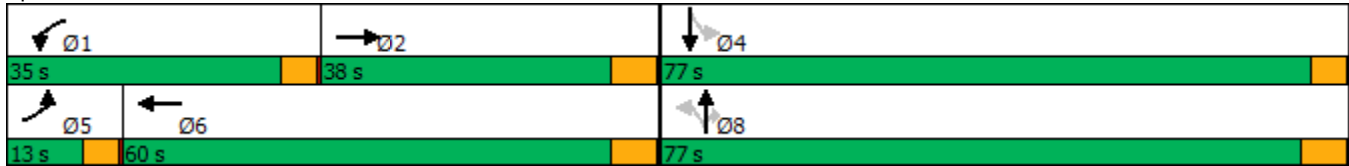

HCS7 Two-Way Stop-Control Report

General Information				Site Information			
Analyst	Montgomery	Intersection	Willamette/US 730				
Agency/Co.	JUB Engineers	Jurisdiction	City of Umatilla				
Date Performed	11/18/2022	East/West Street	6th Street (US 730)				
Analysis Year	2028	North/South Street	Willamette St				
Time Analyzed	PM Pk Hr	Peak Hour Factor	0.83				
Intersection Orientation	East-West	Analysis Time Period (hrs)	0.25				
Project Description	Umatilla Transportation System Plan						

Lanes

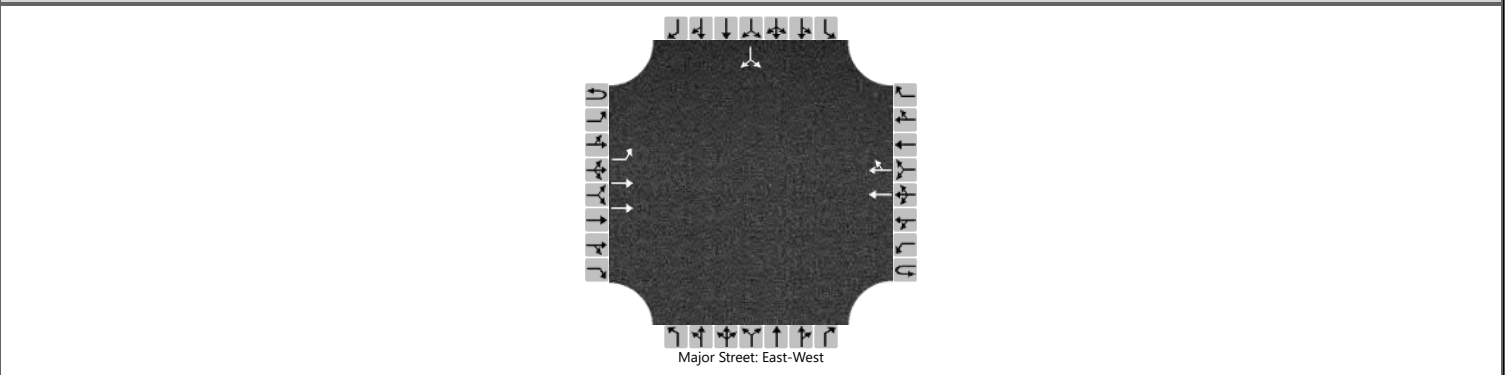

Vehicle Volumes and Adjustments

Approach	Eastbound				Westbound				Northbound				Southbound			
	U	L	T	R	U	L	T	R	U	L	T	R	U	L	T	R
Movement	1U	1	2	3	4U	4	5	6		7	8	9		10	11	12
Priority																
Number of Lanes	0	1	2	0	0	0	2	0	0	0	0	0	0	1	0	
Configuration		L	T				T	TR							LR	
Volume (veh/h)	0	340	180				480	100						30		165
Percent Heavy Vehicles (%)	3	3												3		3
Proportion Time Blocked																
Percent Grade (%)													0			
Right Turn Channelized																
Median Type Storage	Undivided															

Critical and Follow-up Headways

Base Critical Headway (sec)		4.1												7.5		6.9
Critical Headway (sec)		4.16												6.86		6.96
Base Follow-Up Headway (sec)		2.2												3.5		3.3
Follow-Up Headway (sec)		2.23												3.53		3.33

Delay, Queue Length, and Level of Service

Flow Rate, v (veh/h)		410														235
Capacity, c (veh/h)		887														241
v/c Ratio		0.46														0.97
95% Queue Length, Q ₉₅ (veh)		2.5														9.0
Control Delay (s/veh)		12.5														95.3
Level of Service (LOS)		B														F
Approach Delay (s/veh)	8.2												95.3			
Approach LOS													F			

HCS7 Two-Way Stop-Control Report

General Information				Site Information			
Analyst	Montgomery	Intersection	Willamette/US 730				
Agency/Co.	JUB Engineers	Jurisdiction	City of Umatilla				
Date Performed	11/18/2022	East/West Street	6th Street (US 730)				
Analysis Year	2033	North/South Street	Willamette St				
Time Analyzed	PM Pk Hr	Peak Hour Factor	0.83				
Intersection Orientation	East-West	Analysis Time Period (hrs)	0.25				
Project Description	Umatilla Transportation System Plan						

Lanes

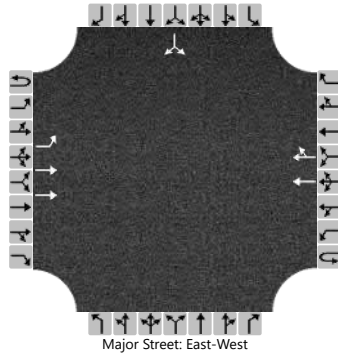

Vehicle Volumes and Adjustments

Approach	Eastbound				Westbound				Northbound				Southbound			
	U	L	T	R	U	L	T	R	U	L	T	R	U	L	T	R
Movement	1U	1	2	3	4U	4	5	6		7	8	9		10	11	12
Priority																
Number of Lanes	0	1	2	0	0	0	2	0	0	0	0	0	0	1	0	
Configuration		L	T				T	TR							LR	
Volume (veh/h)	0	385	220				620	125						35		185
Percent Heavy Vehicles (%)	3	3												3		3
Proportion Time Blocked																
Percent Grade (%)													0			
Right Turn Channelized																
Median Type Storage	Undivided															

Critical and Follow-up Headways

Base Critical Headway (sec)		4.1												7.5		6.9
Critical Headway (sec)		4.16												6.86		6.96
Base Follow-Up Headway (sec)		2.2												3.5		3.3
Follow-Up Headway (sec)		2.23												3.53		3.33

Delay, Queue Length, and Level of Service

Flow Rate, v (veh/h)		464													265		
Capacity, c (veh/h)		746													120		
v/c Ratio		0.62													2.20		
95% Queue Length, Q ₉₅ (veh)		4.4													22.5		
Control Delay (s/veh)		17.4													627.1		
Level of Service (LOS)		C													F		
Approach Delay (s/veh)		11.1												627.1			
Approach LOS														F			

HCS7 Two-Way Stop-Control Report

General Information				Site Information			
Analyst	Montgomery	Intersection	Willamette/US 730				
Agency/Co.	JUB Engineers	Jurisdiction	City of Umatilla				
Date Performed	11/18/2022	East/West Street	6th Street (US 730)				
Analysis Year	2033	North/South Street	Willamette St				
Time Analyzed	PM Pk Hr	Peak Hour Factor	0.83				
Intersection Orientation	East-West	Analysis Time Period (hrs)	0.25				
Project Description	Umatilla Transportation System Plan						

Lanes

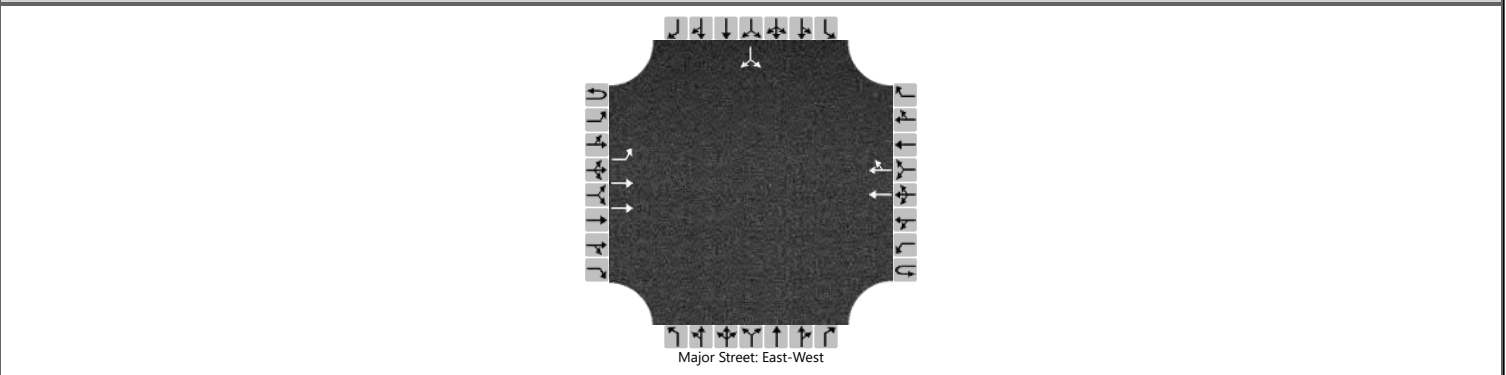

Vehicle Volumes and Adjustments

Approach	Eastbound				Westbound				Northbound				Southbound			
	U	L	T	R	U	L	T	R	U	L	T	R	U	L	T	R
Movement	1U	1	2	3	4U	4	5	6		7	8	9		10	11	12
Priority																
Number of Lanes	0	1	2	0	0	0	2	0	0	0	0	0	0	1	0	
Configuration		L	T				T	TR							LR	
Volume (veh/h)	0	385	220				620	125						35		185
Percent Heavy Vehicles (%)	3	3												3		3
Proportion Time Blocked																
Percent Grade (%)														0		
Right Turn Channelized																
Median Type Storage	Undivided															

Critical and Follow-up Headways

Base Critical Headway (sec)		4.1												7.5		6.9
Critical Headway (sec)		4.16												6.86		6.96
Base Follow-Up Headway (sec)		2.2												3.5		3.3
Follow-Up Headway (sec)		2.23												3.53		3.33

Delay, Queue Length, and Level of Service

Flow Rate, v (veh/h)		464														265	
Capacity, c (veh/h)		746														120	
v/c Ratio		0.62														2.20	
95% Queue Length, Q ₉₅ (veh)		4.4														22.5	
Control Delay (s/veh)		17.4														627.1	
Level of Service (LOS)		C														F	
Approach Delay (s/veh)		11.1												627.1			
Approach LOS													F				

HCS7 Two-Way Stop-Control Report

General Information		Site Information	
Analyst	Montgomery	Intersection	Willamette/US 730
Agency/Co.	JUB Engineers	Jurisdiction	City of Umatilla
Date Performed	11/18/2022	East/West Street	6th Street (US 730)
Analysis Year	2038	North/South Street	Willamette St
Time Analyzed	PM Pk Hr	Peak Hour Factor	0.83
Intersection Orientation	East-West	Analysis Time Period (hrs)	0.25
Project Description	Umatilla Transportation System Plan		

Lanes

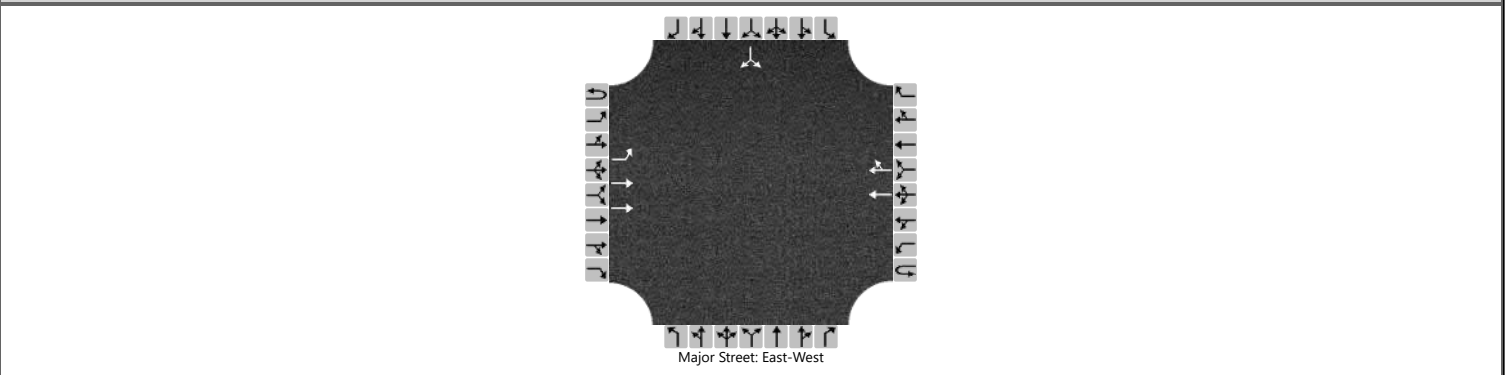

Vehicle Volumes and Adjustments

Approach	Eastbound				Westbound				Northbound				Southbound			
	U	L	T	R	U	L	T	R	U	L	T	R	U	L	T	R
Movement	1U	1	2	3	4U	4	5	6		7	8	9		10	11	12
Priority																
Number of Lanes	0	1	2	0	0	0	2	0	0	0	0	0	0	1	0	
Configuration		L	T				T	TR							LR	
Volume (veh/h)	0	395	240				720	145						35		185
Percent Heavy Vehicles (%)	3	3												3		3
Proportion Time Blocked																
Percent Grade (%)														0		
Right Turn Channelized																
Median Type Storage	Undivided															

Critical and Follow-up Headways

Base Critical Headway (sec)		4.1												7.5		6.9
Critical Headway (sec)		4.16												6.86		6.96
Base Follow-Up Headway (sec)		2.2												3.5		3.3
Follow-Up Headway (sec)		2.23												3.53		3.33

Delay, Queue Length, and Level of Service

Flow Rate, v (veh/h)		476														265	
Capacity, c (veh/h)		657														72	
v/c Ratio		0.72														3.67	
95% Queue Length, Q ₉₅ (veh)		6.2														27.7	
Control Delay (s/veh)		23.5														1319.3	
Level of Service (LOS)		C														F	
Approach Delay (s/veh)		14.6												1319.3			
Approach LOS														F			

HCS7 Two-Way Stop-Control Report

General Information		Site Information	
Analyst	Montgomery	Intersection	Bud Draper Rd/US 730
Agency/Co.	JUB Engineers	Jurisdiction	City of Umatilla
Date Performed	11/18/2022	East/West Street	6th Street (US 730)
Analysis Year	2038	North/South Street	Bud Draper Rd
Time Analyzed	PM Pk Hr - season adj	Peak Hour Factor	0.82
Intersection Orientation	East-West	Analysis Time Period (hrs)	0.25
Project Description	Umatilla Transportation System Plan		

Lanes

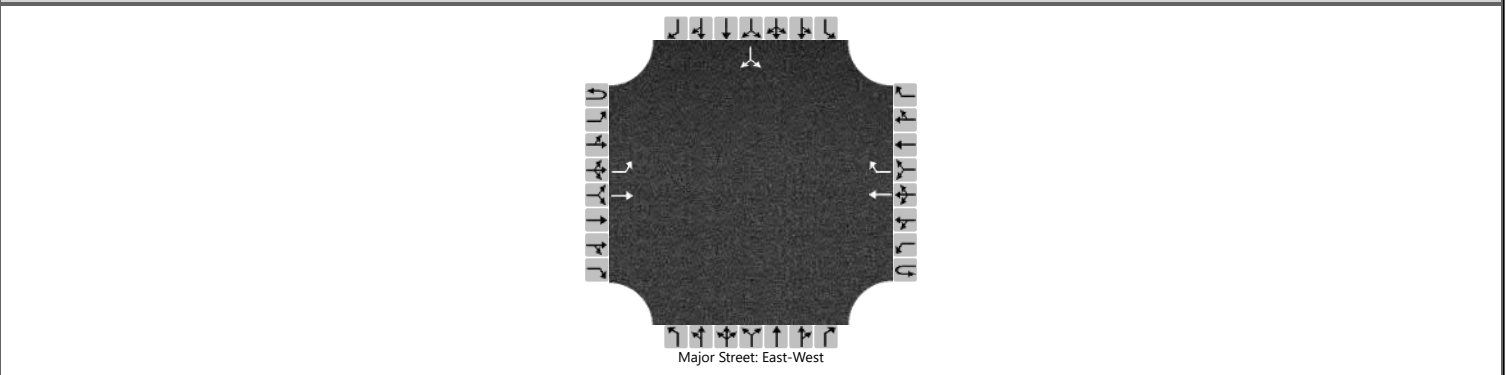

Vehicle Volumes and Adjustments

Approach	Eastbound				Westbound				Northbound				Southbound			
	U	L	T	R	U	L	T	R	U	L	T	R	U	L	T	R
Movement	1U	1	2	3	4U	4	5	6		7	8	9		10	11	12
Priority																
Number of Lanes	0	1	1	0	0	0	1	1		0	0	0		0	1	0
Configuration		L	T				T	R							LR	
Volume (veh/h)		15	265				810	10						15		50
Percent Heavy Vehicles (%)		3												3		3
Proportion Time Blocked																
Percent Grade (%)															0	
Right Turn Channelized							No									
Median Type Storage		Undivided														

Critical and Follow-up Headways

Base Critical Headway (sec)		4.1												7.1		6.2
Critical Headway (sec)		4.13												6.43		6.23
Base Follow-Up Headway (sec)		2.2												3.5		3.3
Follow-Up Headway (sec)		2.23												3.53		3.33

Delay, Queue Length, and Level of Service

Flow Rate, v (veh/h)		18														79	
Capacity, c (veh/h)		688														250	
v/c Ratio		0.03														0.32	
95% Queue Length, Q ₉₅ (veh)		0.1														1.3	
Control Delay (s/veh)		10.4														26.0	
Level of Service (LOS)		B														D	
Approach Delay (s/veh)		0.6												26.0			
Approach LOS													D				

HCS7 Two-Way Stop-Control Report

General Information				Site Information			
Analyst	Montgomery	Intersection	Powerline/Madison				
Agency/Co.	JUB Engineers	Jurisdiction	City of Umatilla				
Date Performed	11/18/2022	East/West Street	Madison Street				
Analysis Year	2038	North/South Street	Powerline Road				
Time Analyzed	PM Pk Hr season adj	Peak Hour Factor	0.88				
Intersection Orientation	North-South	Analysis Time Period (hrs)	0.25				
Project Description	Umatilla Transportation System Plan						

Lanes

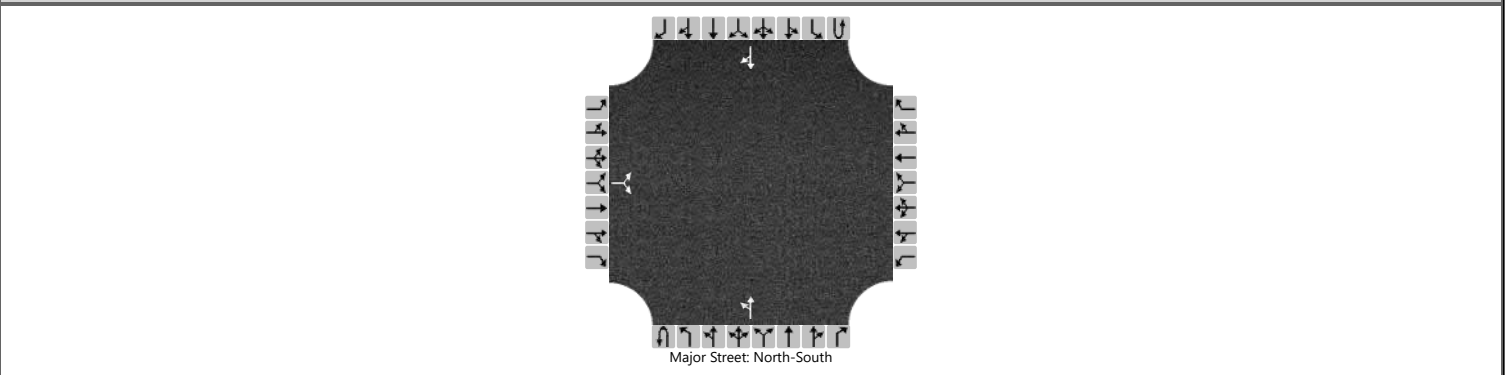

Vehicle Volumes and Adjustments

Approach	Eastbound				Westbound				Northbound				Southbound			
	U	L	T	R	U	L	T	R	U	L	T	R	U	L	T	R
Priority		10	11	12		7	8	9	1U	1	2	3	4U	4	5	6
Number of Lanes		0	1	0		0	0	0	0	0	1	0	0	0	1	0
Configuration			LR							LT						TR
Volume (veh/h)		80		15						20	410				370	115
Percent Heavy Vehicles (%)		3		3						3						
Proportion Time Blocked																
Percent Grade (%)		0														
Right Turn Channelized																
Median Type Storage		Undivided														

Critical and Follow-up Headways

Base Critical Headway (sec)		7.1		6.2						4.1						
Critical Headway (sec)		6.43		6.23						4.13						
Base Follow-Up Headway (sec)		3.5		3.3						2.2						
Follow-Up Headway (sec)		3.53		3.33						2.23						

Delay, Queue Length, and Level of Service

Flow Rate, v (veh/h)			108							23						
Capacity, c (veh/h)			286							1014						
v/c Ratio			0.38							0.02						
95% Queue Length, Q ₉₅ (veh)			1.7							0.1						
Control Delay (s/veh)			25.0							8.6						
Level of Service (LOS)			D							A						
Approach Delay (s/veh)		25.0								0.7						
Approach LOS		D														

Appendix L
Planning Level Cost Estimates

City of Umatilla Transportation System Plan

Project Cost Estimates

(letters correspond to projects in Figure 8-1 of Transportation System Plan)

A. Powerline Road/US 730 - Single Lane Roundabout

	units	Quantity	Unit Price	Cost
single lane roundabout				\$ 775,620.00
Mobilization		LS	7%	\$ 54,293.40
Sub-total				\$ 829,913.40
Contingency			30%	\$ 248,974.02
Construction Total				\$ 1,078,887.42
PE				15% \$ 161,833.11
CE				15% \$ 161,833.11
ROW	AC	0.00	\$ 196,020	\$ -
Total				\$ 1,402,553.65

B. River Road/ US 730 - Traffic Signal

	units	Quantity	Unit Price	Cost
Traffic Signal				\$ 500,000.00
Mobilization		LS	7%	\$ 35,000.00
Sub-total				\$ 535,000.00
Contingency			30%	\$ 160,500.00
Construction Total				\$ 695,500.00
PE				10% \$ 69,550.00
CE				15% \$ 104,325.00
ROW	AC	0	\$ 196,020	\$ -
Total				\$ 869,375.00

C. US 730/I-82 Northbound ramps - add traffic signal and 250' westbound right turn lane plus taper

	length units	width Quantity	Unit Price	Cost
Utility adjustments	LS	1	\$ 25,000.00	\$ 25,000.00
Landscape removal and restoration	LF		\$ -	\$ -
C&G REMOVAL	LF		\$ -	\$ -
SIDEWALK REMOVAL	SY		\$ -	\$ -
HMA REMOVAL	SY	94.44444444	\$ 10.00	\$ 944.44
Earthwork	CY	156	\$ 16.00	\$ 2,488.89
rock & asphalt for RT turn lane and shoulder	LS	2	\$ 25,000.00	\$ 50,000.00
drainage	LF	700	\$ 75.00	\$ 52,500.00
Striping	LF	700	\$ 2.00	\$ 1,400.00
C&G	LF	1100	\$ 20.00	\$ 22,000.00
S/W	SY	611.11111111	\$ 55.00	\$ 33,611.11
Illumination system	LS	1	\$ 30,000.00	\$ 30,000.00
Temporary traffic control	LS	1	\$ 75,000.00	\$ 75,000.00
traffic signal	LS	1	\$ 500,000.00	\$ 500,000.00
SURVEYING	LS	1	\$ 15,000.00	\$ 15,000.00
Mobilization	LS		7%	\$ 56,556.11
Sub-total				\$ 864,500.56
Contingency				30% \$ 259,350.17
Construction Total				\$ 1,123,850.72
PE				12% \$ 134,862.09
CE				15% \$ 168,577.61
ROW	AC	0.03	\$ 196,020	\$ 5,880.60
Total				\$ 1,433,171.02

D. US 730/US 395 - add 2nd northbound left and 2nd westbound left turn lane, with southbound receiving lane

	length	width			
	3125	18			
	units	Quantity	Unit Price		Cost
Utility adjustments	LS	1	\$ 300,000.00		\$ 300,000.00
Earthwork	CY	8021	\$ 16.00		\$ 128,333.33
10" Rock	TN	3299	\$ 47.50		\$ 156,684.03
4" Asphalt	TN	1458	\$ 130.00		\$ 189,583.33
drainage	LF	3125	\$ 75.00		\$ 234,375.00
Striping	LF	9375	\$ 2.00		\$ 18,750.00
Curb & Gutter	LF	5500	\$ 20.00		\$ 110,000.00
Sidewalk (5' wide)	SY	3056	\$ 55.00		\$ 168,055.56
Street Lights (assume 300' spacing)	EACH	10	\$ 12,000.00		\$ 120,000.00
traffic signal	LS	1	\$ 500,000.00		\$ 500,000.00
Landscaping	LS	1	\$ 25,000.00		\$ 25,000.00
Temporary traffic control	LS	1	\$ 175,000.00		\$ 175,000.00
Surveying	LS	1	\$ 50,000.00		\$ 50,000.00
Mobilization	LS		7%		\$ 115,554.69
Sub-total					\$ 2,291,335.94
Contingency			30%		\$ 687,400.78
Construction Total					\$ 2,978,736.72
PE			15%		\$ 446,810.51
CE			15%		\$ 446,810.51
ROW	AC	0.69	\$ 196,020		\$ 135,000.00
Total					\$ 4,007,357.73

E. Willamette/US 730 - add southbound left turn lane, modify north leg island

	200	12			
	units	Quantity	Unit Price		Cost
Earthwork	CY	104	\$ 16.00		\$ 1,659.26
10" Rock	TN	141	\$ 47.50		\$ 6,685.19
4" Asphalt	TN	62	\$ 130.00		\$ 8,088.89
drainage	LF	200	\$ 75.00		\$ 15,000.00
Striping	LF	800	\$ 2.00		\$ 1,600.00
Temporary traffic control	LS	1	\$ 10,000.00		\$ 10,000.00
SURVEYING	LS	1	\$ 5,000.00		\$ 5,000.00
HMA REMOVAL	SY	22.22222222	\$ 10.00		\$ 222.22
Mobilization	LS		7%		\$ 3,377.89
subtotal					\$ 51,633.44
Contingency			30%		\$ 15,490.03
Construction Total					\$ 67,123.48
PE			40%		\$ 26,849.39
CE			20%		\$ 13,424.70
ROW	AC	0.00	\$ 196,020		\$ -
Total					\$ 107,397.56

F. Columbia/US 730 - add southbound left turn lane, northbound receiving lane eastbound left turn lane to connect with WBL from US 395 (split at 750' each)

Turn lanes and TWLTL	1050	18			
	units	Quantity	Unit Price		Cost
Earthwork	CY	817	\$ 16.00		\$ 13,066.67
10" Rock	TN	1108	\$ 47.50		\$ 52,645.83
4" Asphalt	TN	490	\$ 130.00		\$ 63,700.00
drainage	LF	1050	\$ 75.00		\$ 78,750.00
Striping	LF	4200	\$ 2.00		\$ 8,400.00
Curb & Gutter	LF	1000	\$ 20.00		\$ 20,000.00
Sidewalk (5' wide)	SY	556	\$ 55.00		\$ 30,555.56
Temporary traffic control	LS	1	\$ 30,000.00		\$ 30,000.00
SURVEYING	LS	1	\$ 10,000.00		\$ 10,000.00
HMA REMOVAL	SY	1400	\$ 10.00		\$ 14,000.00
Mobilization	LS		7%		\$ 22,478.26
subtotal					\$ 343,596.32
Contingency			30%		\$ 103,078.90
Construction Total					\$ 446,675.22
PE			15%		\$ 67,001.28
CE			15%		\$ 67,001.28
ROW	AC	0.34	\$ 196,020		\$ 67,500.00
Total					\$ 648,177.78

G. Walla Walla Road Extension - 400' new road, with sidewalks

	400 units	36 Quantity	Unit Price	Cost
Earthwork	CY	1467	\$ 16.00	\$ 23,466.67
10" Rock	TN	844	\$ 47.50	\$ 40,111.11
4" Asphalt	TN	342	\$ 130.00	\$ 44,488.89
drainage	LF	400	\$ 75.00	\$ 30,000.00
Striping	LF	1200	\$ 2.00	\$ 2,400.00
Curb & Gutter	LF	800	\$ 20.00	\$ 16,000.00
Sidewalk (5' wide)	SY	444	\$ 55.00	\$ 24,444.44
Street Lights (assume 300' spacing)	EACH	2	\$ 12,000.00	\$ 24,000.00
Landscaping	LF	400	\$ -	\$ -
SURVEYING	LS	1	\$ 10,000.00	\$ 10,000.00
Mobilization	LS		12%	\$ 25,789.33
Sub-total				\$ 240,700.44
Contingency			30%	\$ 72,210.13
Construction Total				\$ 312,910.58
PE			15%	\$ 46,936.59
CE			15%	\$ 46,936.59
ROW	AC	0.00	\$ 196,020	\$ -
Total				\$ 406,783.75

H. Riverside Avenue Extension - 1050' of new road, with sidewalks

	1050 units	36 Quantity	Unit Price	Cost
Earthwork	CY	3850	\$ 16.00	\$ 61,600.00
10" Rock	TN	2217	\$ 47.50	\$ 105,291.67
4" Asphalt	TN	898	\$ 130.00	\$ 116,783.33
drainage	LF	1050	\$ 75.00	\$ 78,750.00
Striping	LF	3150	\$ 2.00	\$ 6,300.00
Curb & Gutter	LF	2100	\$ 20.00	\$ 42,000.00
Sidewalk (5' wide)	SY	1167	\$ 55.00	\$ 64,166.67
Street Lights (assume 300' spacing)	EACH	4	\$ 12,000.00	\$ 48,000.00
Landscaping	LF	1050	\$ -	\$ -
SURVEYING	LS	1	\$ 10,000.00	\$ 10,000.00
Mobilization	LS		7%	\$ 37,302.42
Sub-total				\$ 570,194.08
Contingency			30%	\$ 171,058.23
Construction Total				\$ 741,252.31
PE			15%	\$ 111,187.85
CE			15%	\$ 111,187.85
ROW	AC	0.00	\$ 196,020	\$ -
Total				\$ 963,628.00

I. Beach Access/US 730 - Lengthen southbound right turn lane from 250' to 750'

	525 units	12 Quantity	Unit Price	Cost
Earthwork	CY	272	\$ 16.00	\$ 4,355.56
10" Rock	TN	369	\$ 47.50	\$ 17,548.61
4" Asphalt	TN	163	\$ 130.00	\$ 21,233.33
drainage	LF	525	\$ 75.00	\$ 39,375.00
Striping	LF	2100	\$ 2.00	\$ 4,200.00
SURVEYING	LS	1	\$ 10,000.00	\$ 10,000.00
Mobilization	LS		12%	\$ 10,405.50
subtotal				\$ 86,712.50
Contingency			30%	\$ 26,013.75
Construction Total				\$ 112,726.25
PE			30%	\$ 33,817.88
CE			15%	\$ 16,908.94
ROW	AC	0.00	\$ 196,020	\$ -
Total				\$ 163,453.06

J. Madison/Powerline - add eastbound right turn lane (100') and southbound right turn lane (150' + taper)

	275 units	12 Quantity	Unit Price	Cost
Earthwork	CY	143	\$ 16.00	\$ 2,281.48
10" Rock	TN	194	\$ 47.50	\$ 9,192.13
4" Asphalt	TN	86	\$ 130.00	\$ 11,122.22
drainage	LF	275	\$ 75.00	\$ 20,625.00
Curb & Gutter	LF	275	\$ 20.00	\$ 5,500.00
Sidewalk (5' wide)	SY	306	\$ 55.00	\$ 16,805.56
Striping	LF	1100	\$ 2.00	\$ 2,200.00
SURVEYING	LS	1	\$ 10,000.00	\$ 10,000.00
Mobilization	LS		12%	\$ 5,846.50
subtotal				\$ 67,726.39
Contingency			30%	\$ 20,317.92
Construction Total				\$ 88,044.31
PE			30%	\$ 26,413.29
CE			15%	\$ 13,206.65
ROW	AC	0.00	\$ 196,020	\$ -
Total				\$ 127,664.24

K. Powerline Road Phase I - Radar Road south 1.07 miles include Two-way Left-turn lane and sidewalks

separate, more detailed estimate previously prepared

Length	Length (feet)	Cost/foot	Cost
1.07	5,650	\$ 829.26	\$ 4,685,000

L. Powerline Road Phase 2 - US 730 south to Radar Road include Two-way Left-turn lane and sidewalks

1.96 miles

Apply cost/length from K

Length	Length (feet)	Cost per foot	Cost
1.97	10,402	\$ 829.26	\$ 8,625,654



ENGINEER'S OPINION OF PROBABLE COST

9/28/2022

PROJECT DESCRIPTION:

Powerline Road Widening with Separated Bike/Shared-Use Path

CLIENT:

J-U-B PROJ. NO.: 30-16-001-004

PROJECT BID ITEM NUMBER	OREGON STANDARD SPEC BID ITEM NUMBER	ITEM DESCRIPTION	QUANTITY	UNIT	UNIT COST	TOTAL COST
1	0210-0100000A	MOBILIZATION	1	LS	\$ 172,632.74	\$ 172,632.74
2	0225-0101000A	TEMPORARY WORK ZONE TRAFFIC CONTROL, COMPLETE	1	LS	\$ 35,000.00	\$ 35,000.00
3	0280-0100000A	EROSION CONTROL	1	LS	\$ 10,000.00	\$ 10,000.00
4	0305-0100000A	CONSTRUCTION SURVEY WORK	1	LS	\$ 30,000.00	\$ 30,000.00
5	0310-0103000J	REMOVAL OF SURFACINGS	15,120	SQYD	\$ 10.00	\$ 151,200.00
6	0310-0119000F	ASPHALT PAVEMENT SAW CUTTING	50	FOOT	\$ 3.00	\$ 150.00
7	0320-010000A	CLEARING AND GRUBBING	7	ACRE	\$ 4,000.00	\$ 28,115.70
8	0330-0101000K	DITCH EXCAVATION	3,360	CUYD	\$ 7.00	\$ 23,520.00
9	0330-0105000K	GENERAL EXCAVATION	8,930	CUYD	\$ 12.00	\$ 107,160.00
10	0330-0123000K	EMBANKMENT IN PLACE	8,217	CUYD	\$ 20.00	\$ 164,336.30
11	0641-0102000M	AGGREGATE BASE	15,590	TON	\$ 35.00	\$ 545,650.00
12	0744-0100000M	LEVEL 1, 3/8 INCH ACP MIXTURE	740	TON	\$ 120.00	\$ 88,800.00
13	0744-0302000M	LEVEL 3, 1/2 INCH ACP MIXTURE	5,040	TON	\$ 145.00	\$ 730,800.00
14	0759-0103000F	CONC CURBS, CURB AND GUTTER	5,500	FOOT	\$ 18.00	\$ 99,000.00
15	0860-0200F00F	LONGITUDINAL PAVEMENT MARKINGS - PAINT	22,000	FOOT	\$ 0.45	\$ 9,900.00
16	0905-0101000A	REMOVE AND REINSTALL EXISTING SIGN	7	EACH	\$ 500.00	\$ 3,500.00
17	0970-0100000A	POLE FOUNDATIONS	1	LS	\$ 24,750.00	\$ 24,750.00
18	0970-0200000A	LIGHTING POLES AND ARMS	1	LS	\$ 132,000.00	\$ 132,000.00
19	0970-0104000A	LUMINAIRES, LAMPS, AND BALLASTS	1	LS	\$ 49,500.00	\$ 49,500.00
20	0970-0105000A	SWITCHING, CONDUIT, AND WIRING	1	LS	\$ 147,750.00	\$ 147,750.00
21	1050-01000000F	TYPE 1 FENCE	5,670	FOOT	\$ 15.00	\$ 85,050.00
SUBTOTAL CONSTRUCTION COST						\$ 2,638,815
SALES TAX @ 0%						\$ -
CONTINGENCY @ 30%						\$ 791,645
CONSTRUCTION TOTAL						\$ 3,430,460
PRELIMINARY ENGINEERING @ 10%						\$ 343,046
CONSTRUCTION ENGINEERING @ 15%						\$ 514,569
TOTAL PROJECT ESTIMATED COST (2022 DOLLARS)						\$ 4,288,074
CONSTRUCTION COST ESCALATION ESTIMATED AT @ 3% PER YEAR, 3 YEARS						\$ 398,000
TOTAL ESTIMATED COST (2025 DOLLARS)						\$ 4,686,074